

ITP 19-03-2016 Bad Blankenburg Cadets u18 -40

Kämpfer: 10

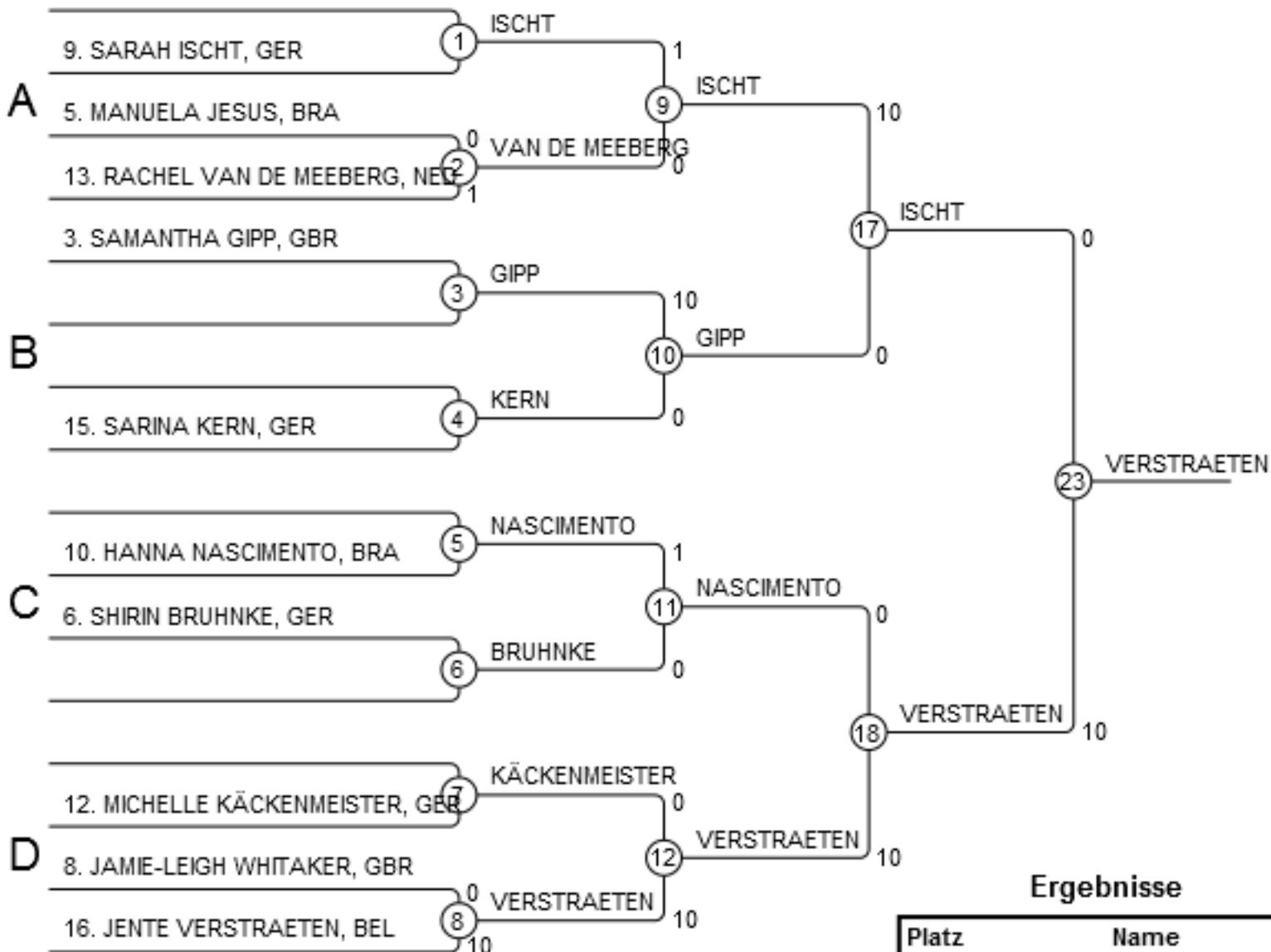

Ergebnisse

Platz	Name
1	JENTE VERSTRAETEN, BEL
2	SARAH ISCHT, GER
3	RACHEL VAN DE MEEBERG, NED
3	SAMANTHA GIPP, GBR
5	HANNA NASCIMENTO, BRA
5	JAMIE-LEIGH WHITAKER, GBR
7	SARINA KERN, GER
7	SHIRIN BRUHNKE, GER

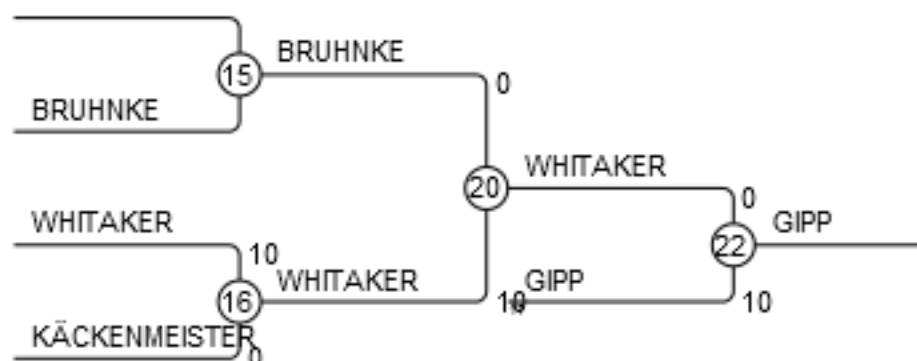
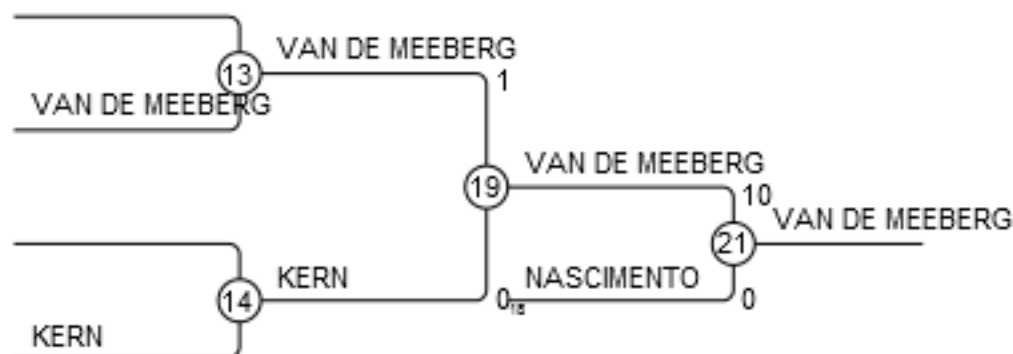

ITP 19-03-2016 Bad Blankenburg Cadets u18 -44

Kämpfer: 22

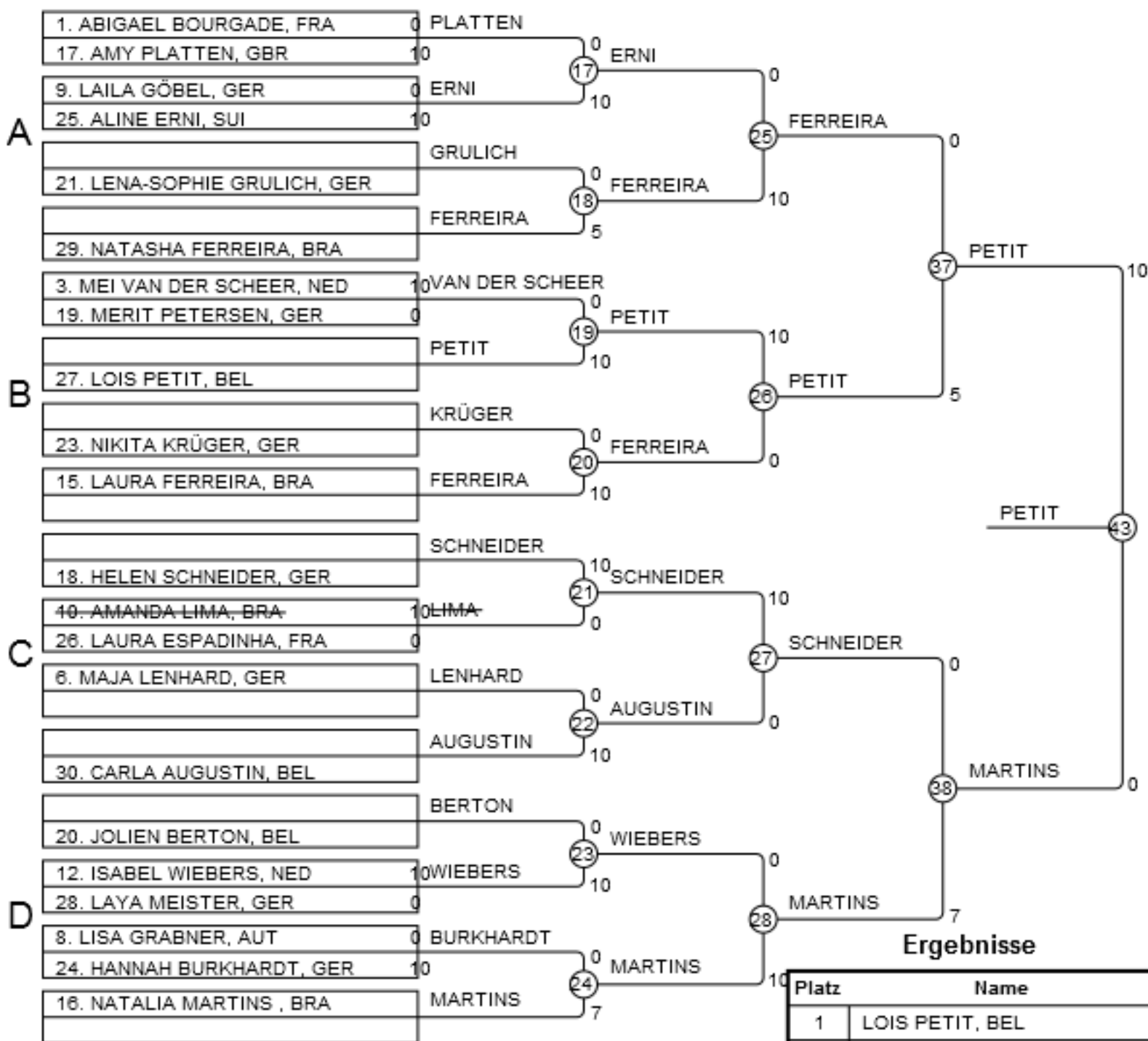

Platz	Name
1	LOIS PETIT, BEL
2	NATALIA MARTINS, BRA
3	LAURA FERREIRA, BRA
3	NATASHA FERREIRA, BRA
5	HELEN SCHNEIDER, GER
5	ISABEL WIEBERS, NED
7	LENA-SOPHIE GRULICH, GER
7	CARLA AUGUSTIN, BEL

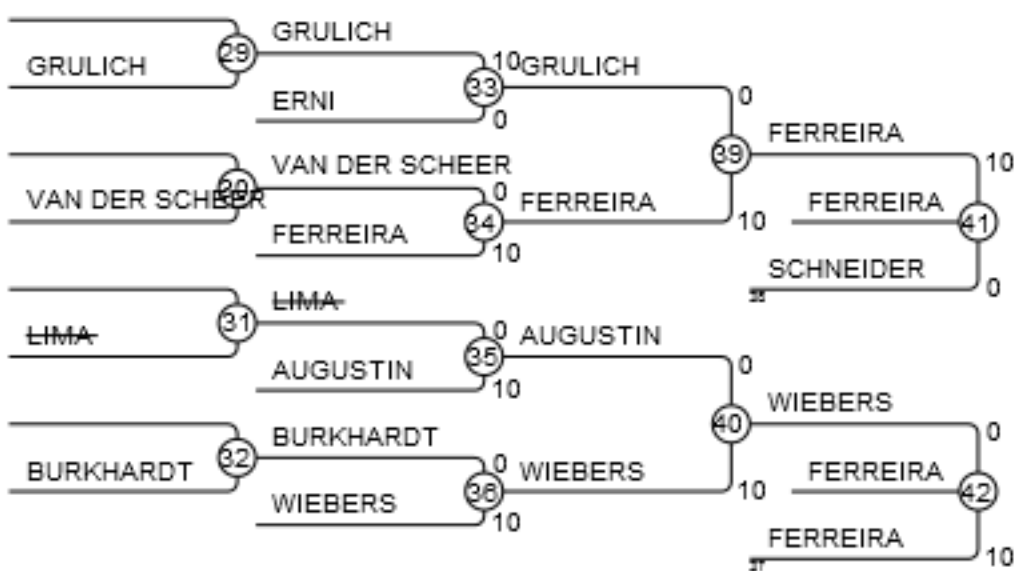

ITP 19-03-2016 Bad Blankenburg Cadets u18 -48

Kämpfer: 32

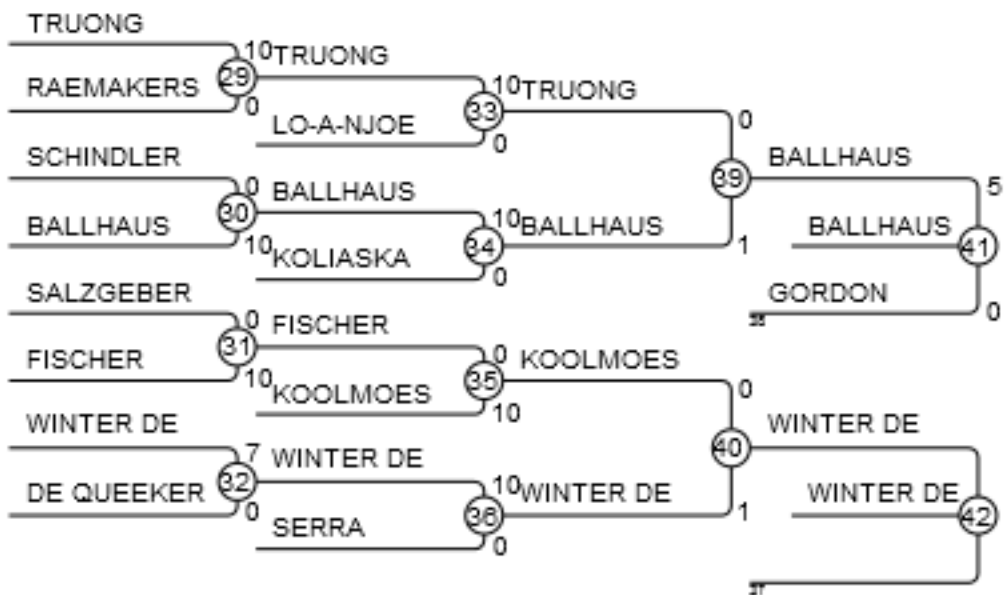
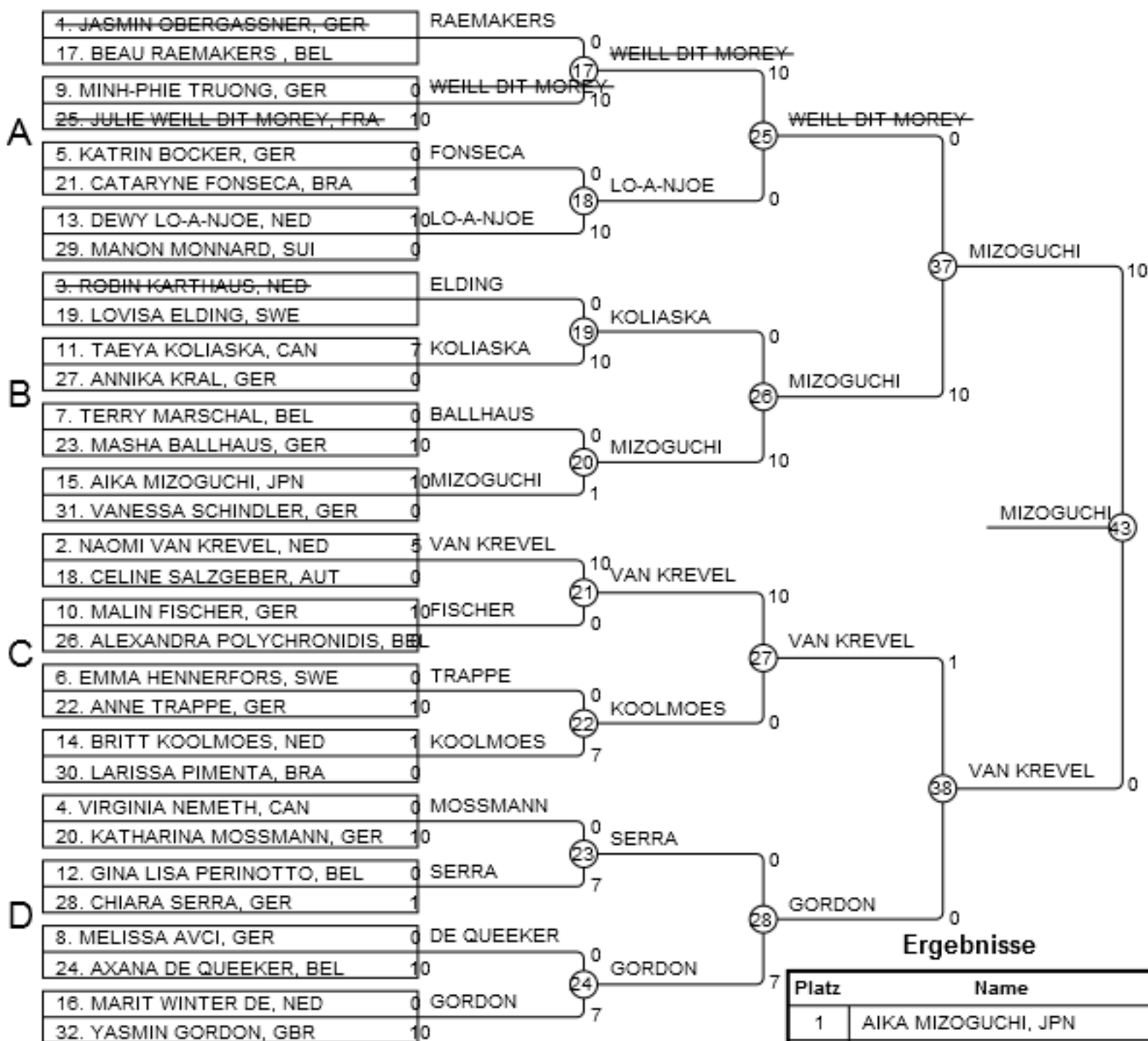

ITP 19-03-2016 Bad Blankenburg Cadets u18 -52 (1/3)

Kämpfer: 46

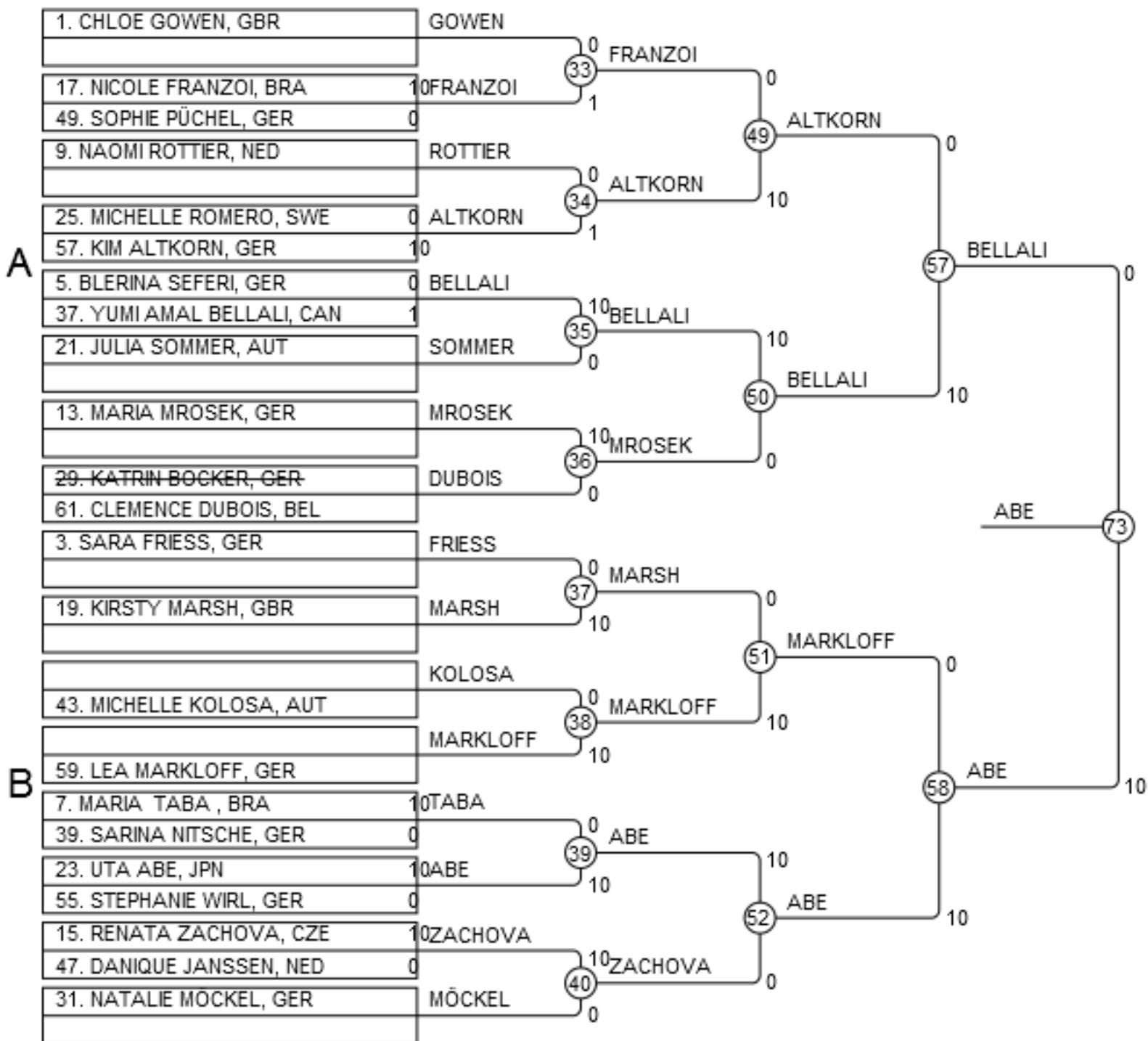

ITP 19-03-2016 Bad Blankenburg Cadets u18 -52 (2/3)

Kämpfer: 46

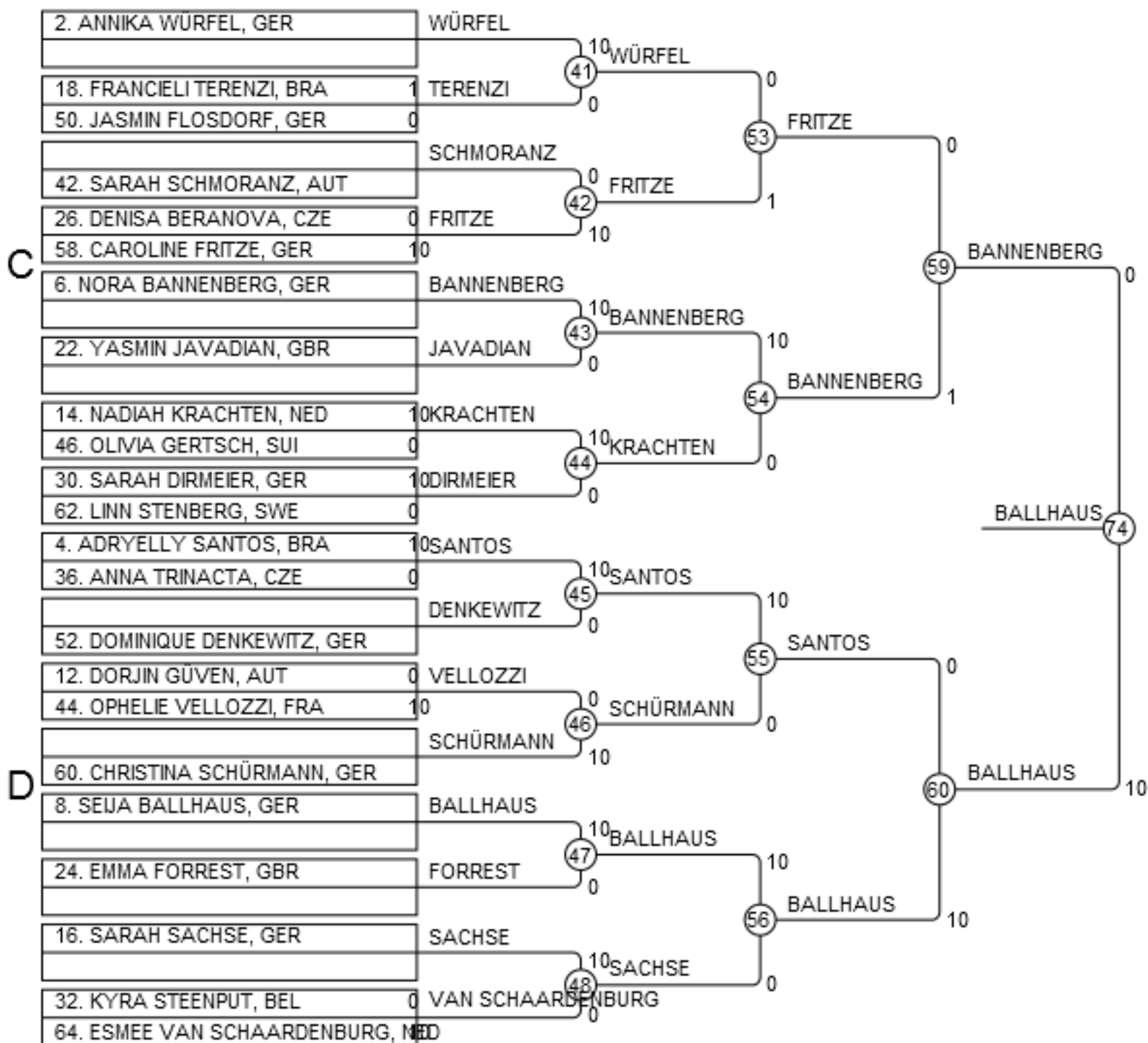

ITP 19-03-2016 Bad Blankenburg Cadets u18 -52 (3/3)

Kämpfer: 46

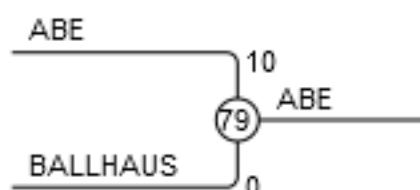
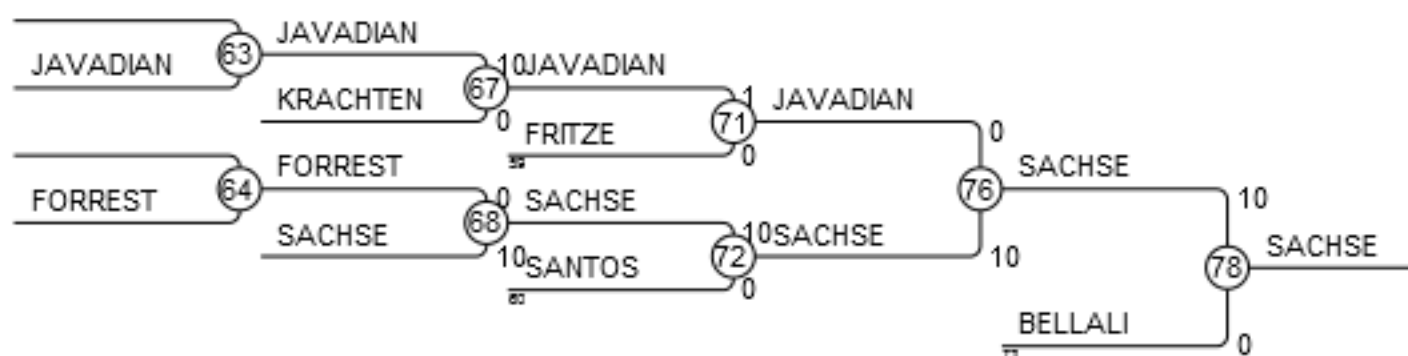
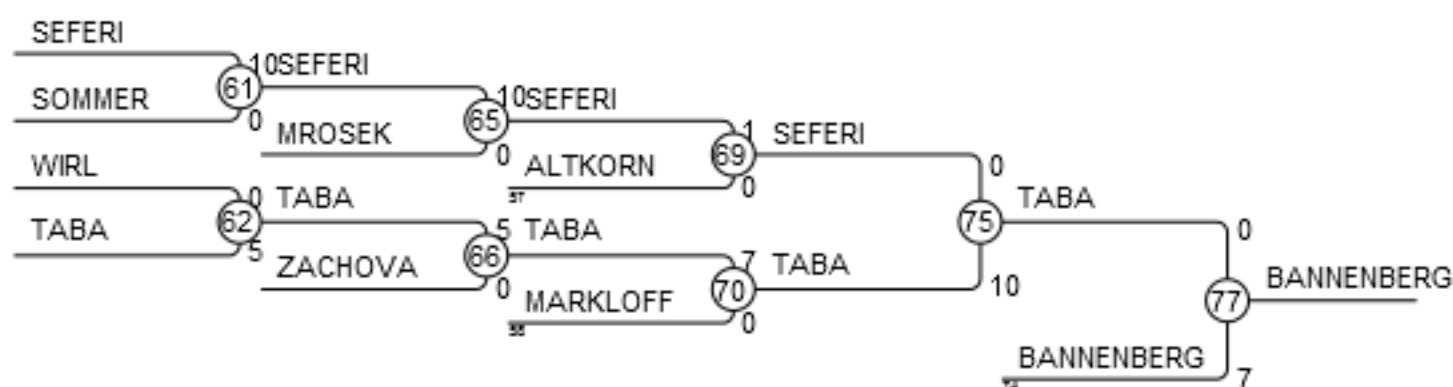

Ergebnisse

Platz	Name
1	UTA ABE, JPN
2	SEIJA BALLHAUS, GER
3	NORA BANNENBERG, GER
3	SARAH SACHSE, GER
5	MARIA TABA, BRA
5	YUMI AMAL BELLALI, CAN
7	BLERINA SEFERI, GER
7	YASMIN JAVADIAN, GBR

ITP 19-03-2016 Bad Blankenburg Cadets u18 -57 (1/3)

Kämpfer: 46

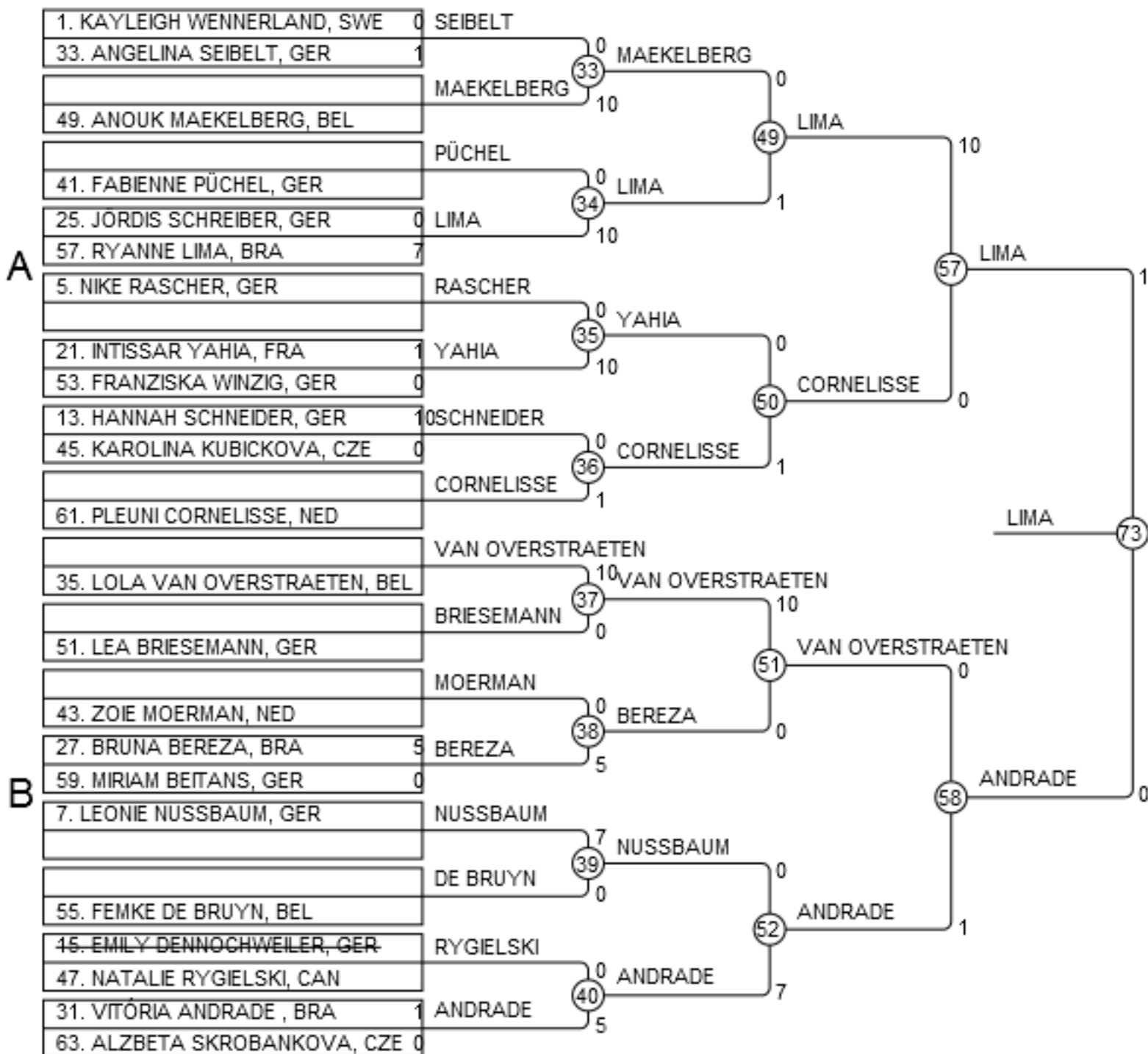

ITP 19-03-2016 Bad Blankenburg Cadets u18 -57 (2/3)

Kämpfer: 46

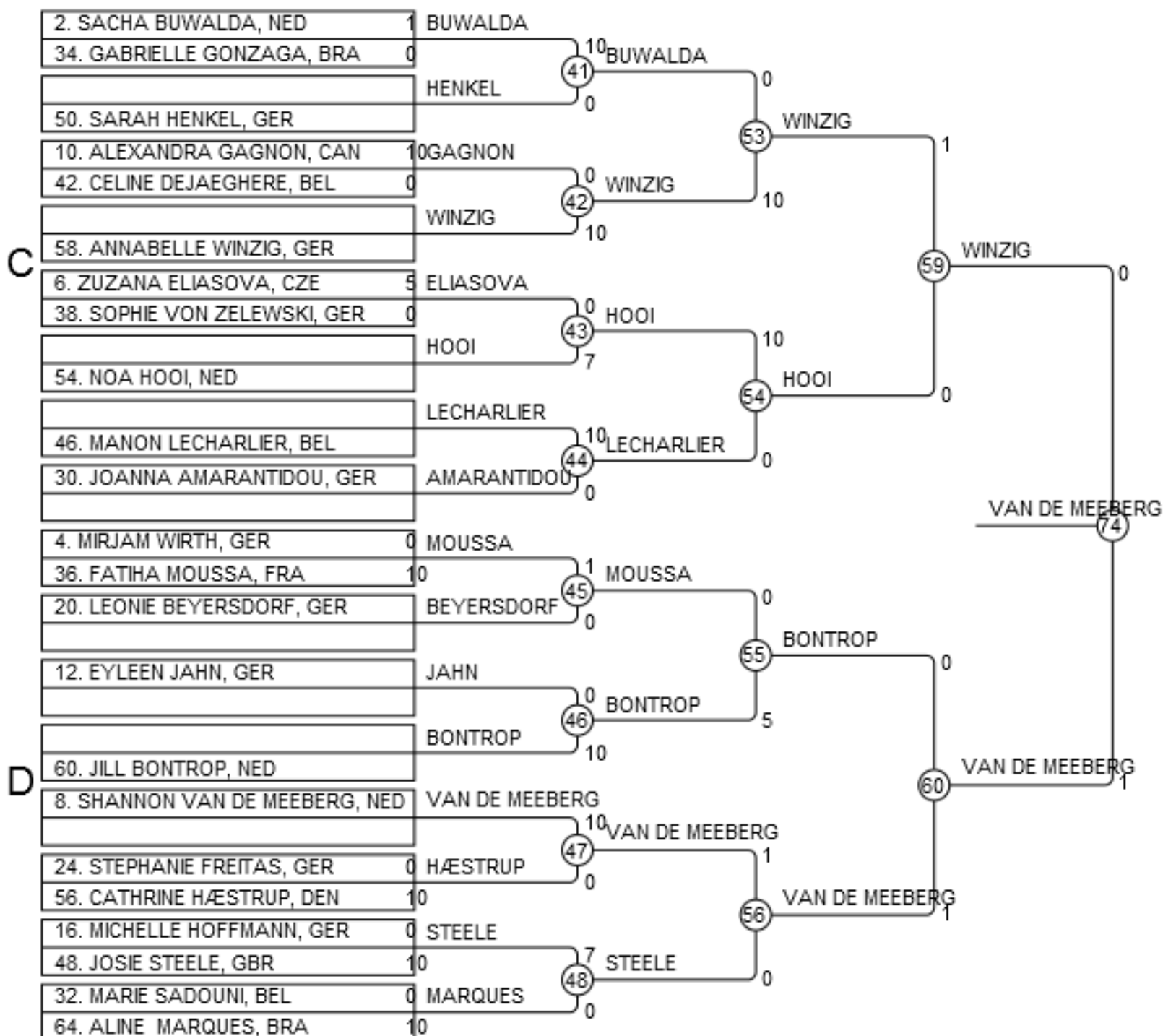

ITP 19-03-2016 Bad Blankenburg Cadets u18 -57 (3/3)

Kämpfer: 46

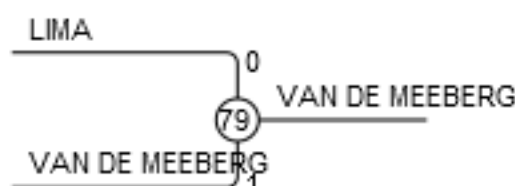
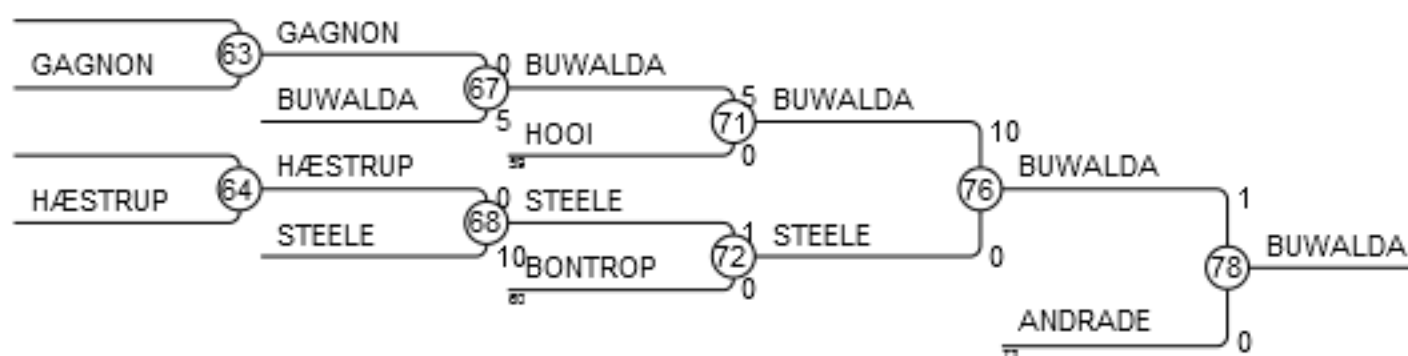
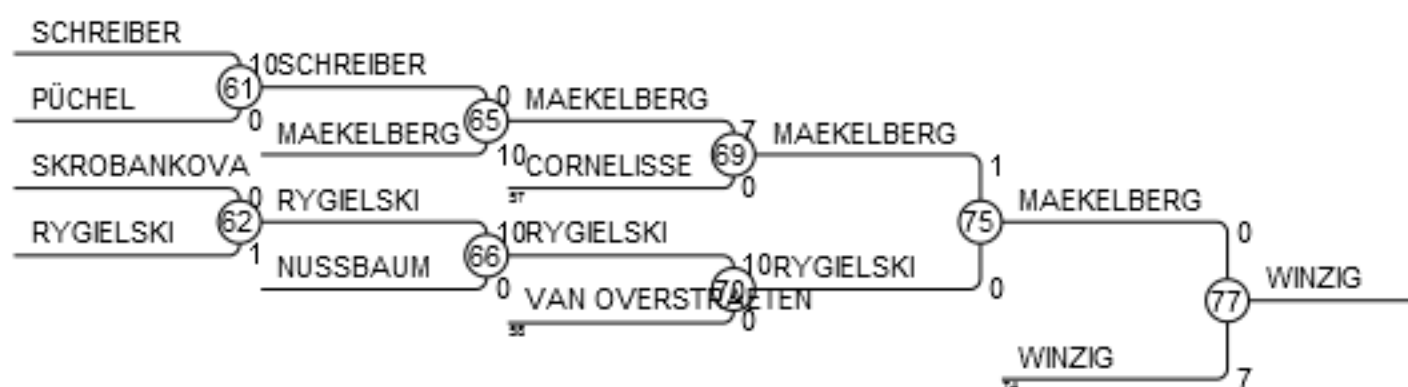

Ergebnisse

Platz	Name
1	SHANNON VAN DE MEEBERG, NED
2	RYANNE LIMA, BRA
3	ANNABELLE WINZIG, GER
3	SACHA BUWALDA, NED
5	ANOUK MAEKELBERG, BEL
5	VITÓRIA ANDRADE, BRA
7	NATALIE RYGIELSKI, CAN
7	JOSIE STEELE, GBR

ITP 19-03-2016 Bad Blankenburg Cadets u18 -63 (1/3)

Kämpfer: 50

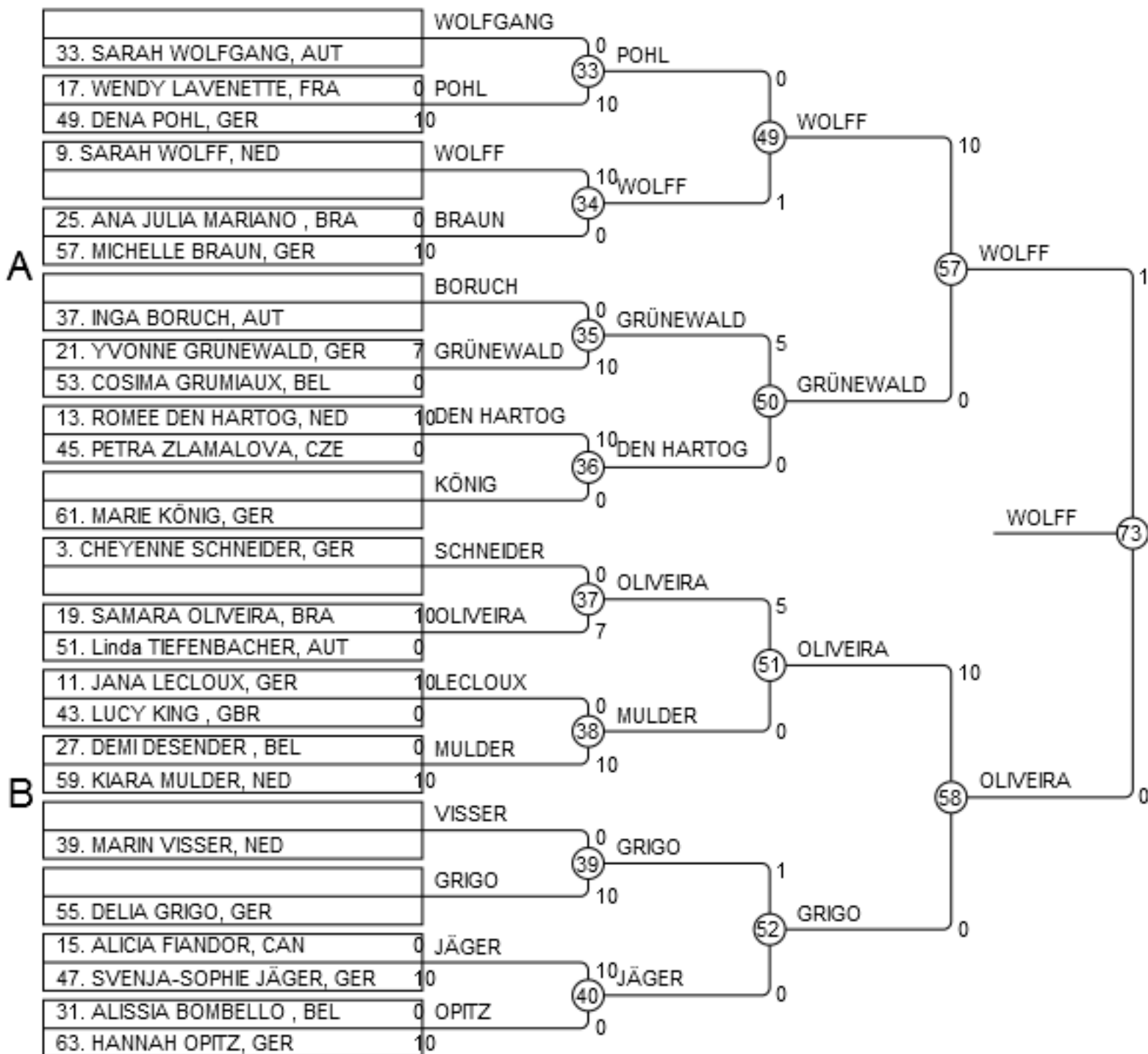

ITP 19-03-2016 Bad Blankenburg Cadets u18 -63 (2/3)

Kämpfer: 50

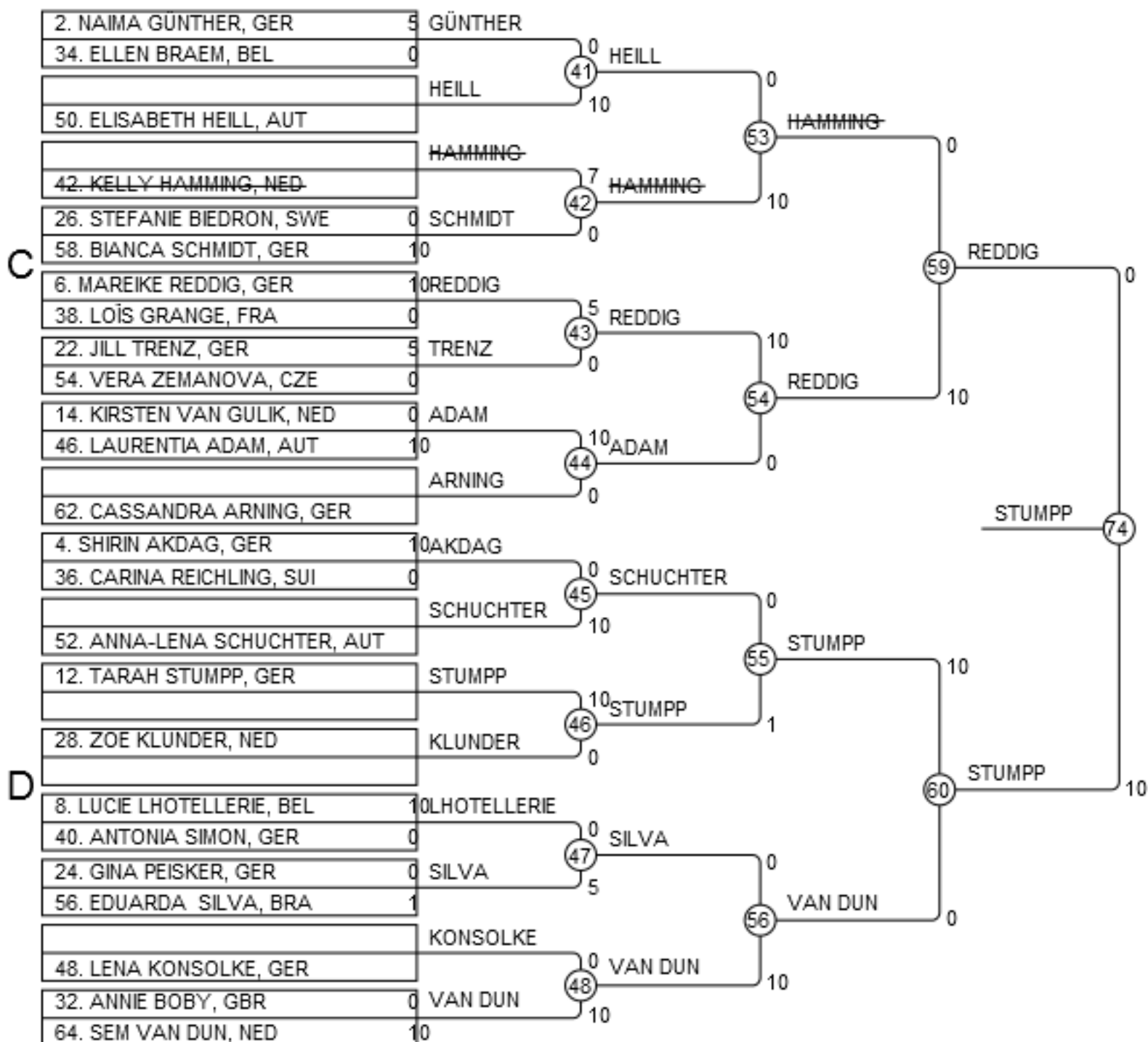

ITP 19-03-2016 Bad Blankenburg Cadets u18 -63 (3/3)

Kämpfer: 50

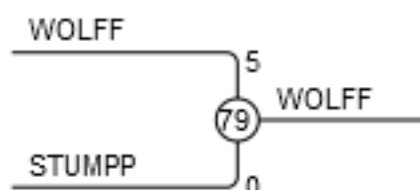
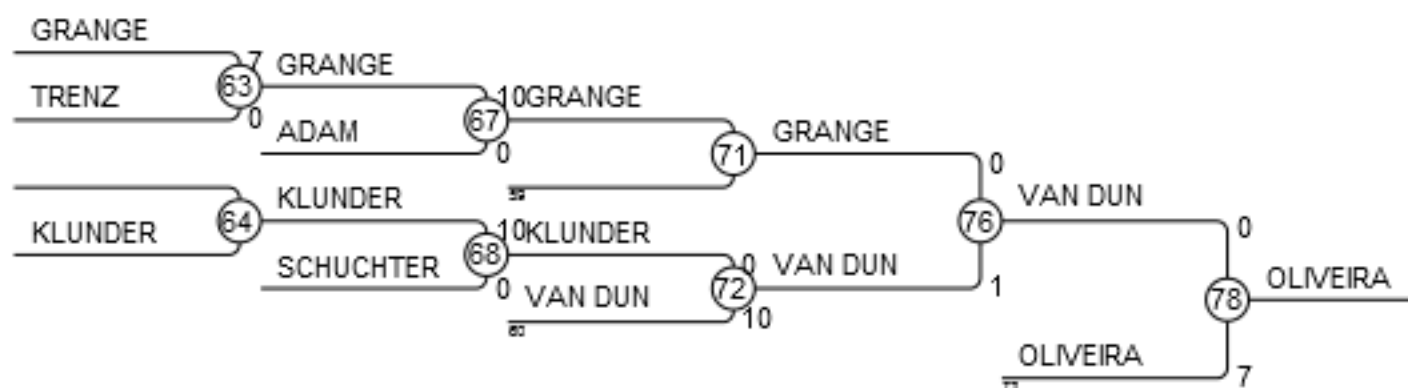
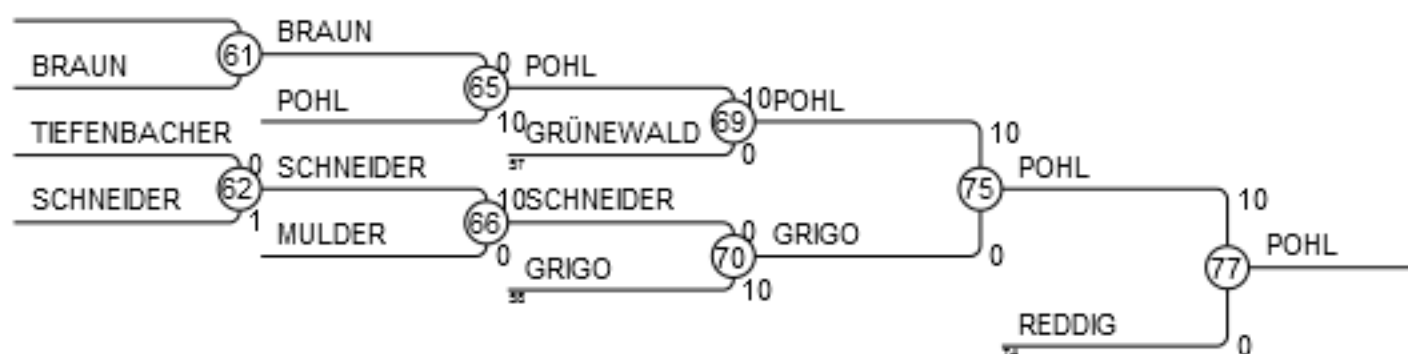

Ergebnisse

Platz	Name
1	SARAH WOLFF, NED
2	TARAH STUMPP, GER
3	DENA POHL, GER
3	SAMARA OLIVEIRA, BRA
5	MAREIKE REDDIG, GER
5	SEM VAN DUN, NED
7	DELIA GRIGO, GER
7	LOÏS GRANGE, FRA

ITP 19-03-2016 Bad Blankenburg Cadets u18 -70 (1/3)

Kämpfer: 36

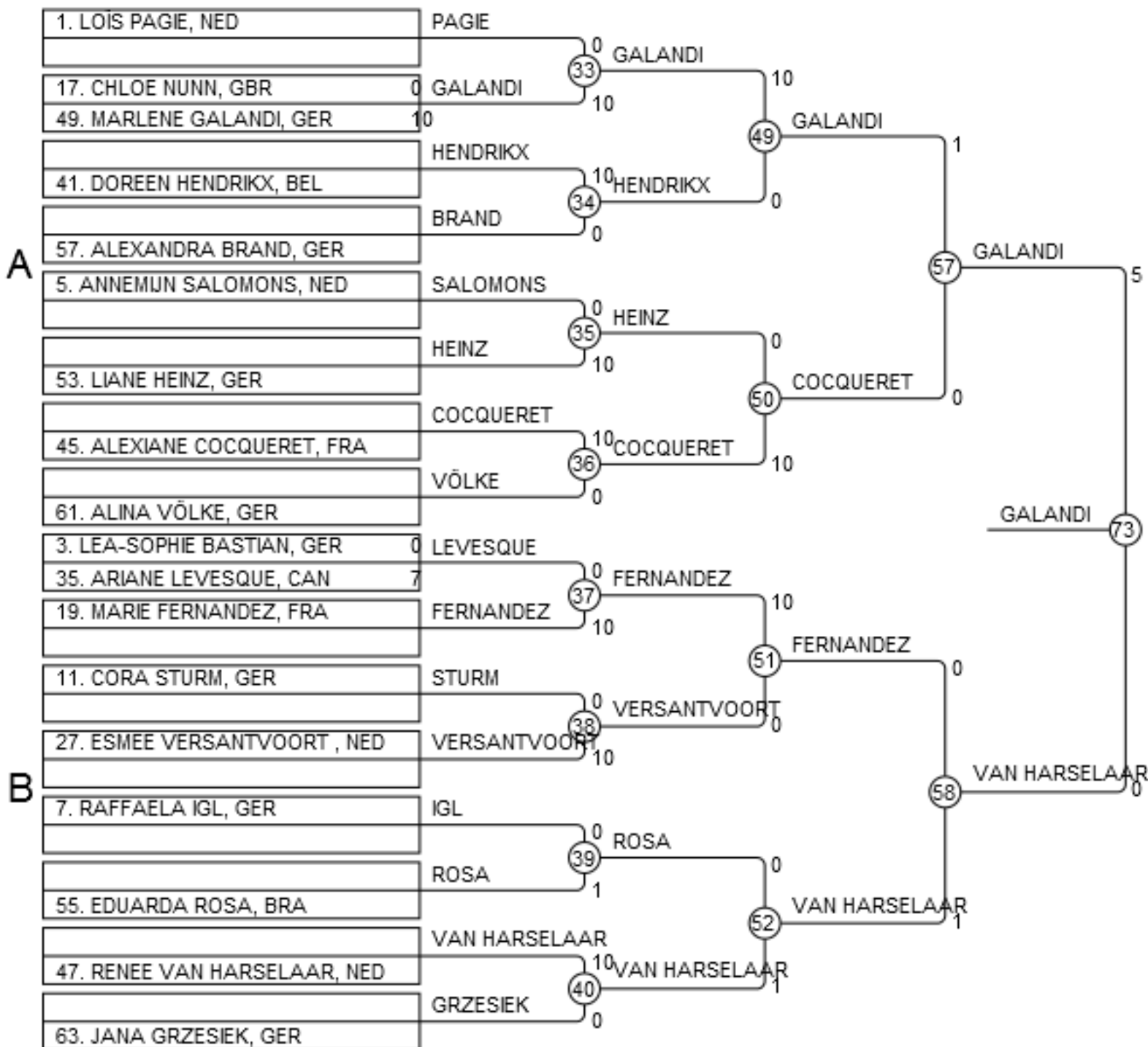

ITP 19-03-2016 Bad Blankenburg Cadets u18 -70 (2/3)

Kämpfer: 36

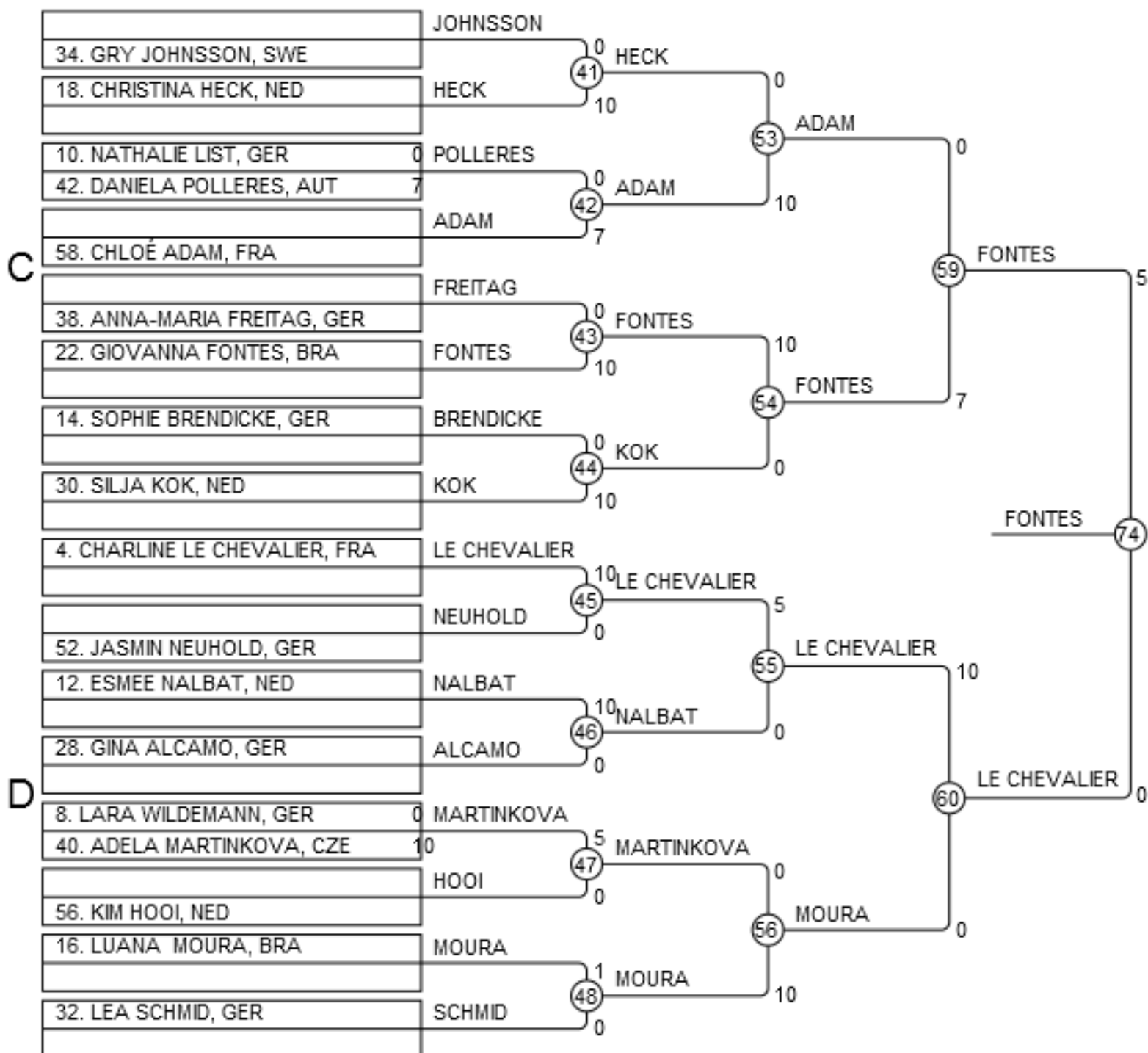

ITP 19-03-2016 Bad Blankenburg Cadets u18 -70 (3/3)

Kämpfer: 36

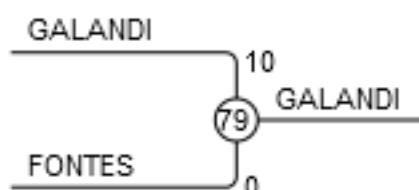
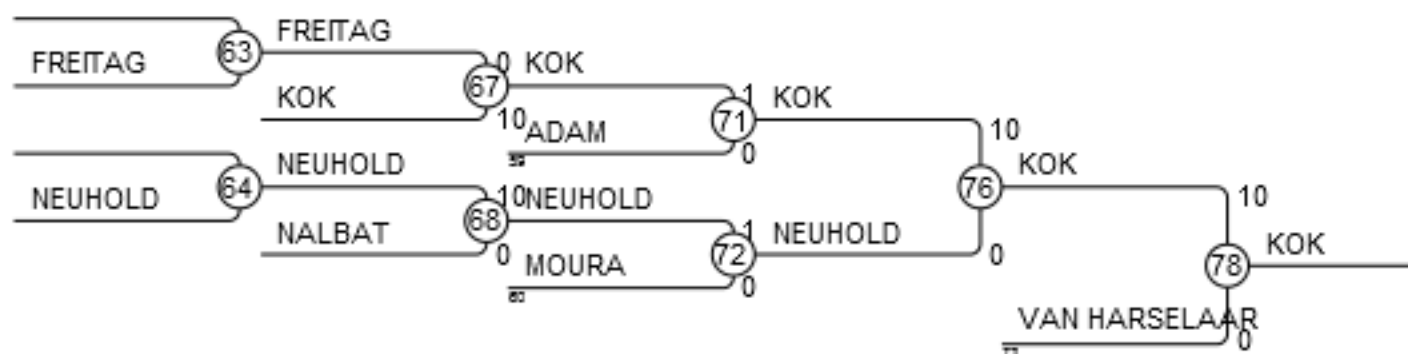
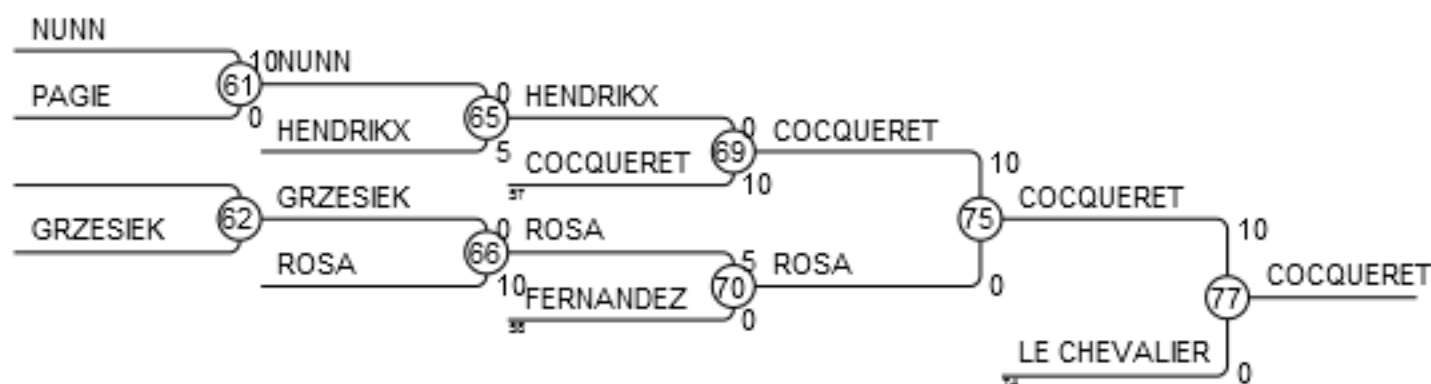

Ergebnisse

Platz	Name
1	MARLENE GALANDI, GER
2	GIOVANNA FONTES, BRA
3	ALEXIANE COCQUERET, FRA
3	SILJA KOK, NED
5	CHARLINE LE CHEVALIER, FRA
5	RENEE VAN HARSELAAR, NED
7	EDUARDA ROSA, BRA
7	JASMIN NEUHOLD, GER

ITP 19-03-2016 Bad Blankenburg Cadets u18 +70

Kämpfer: 20

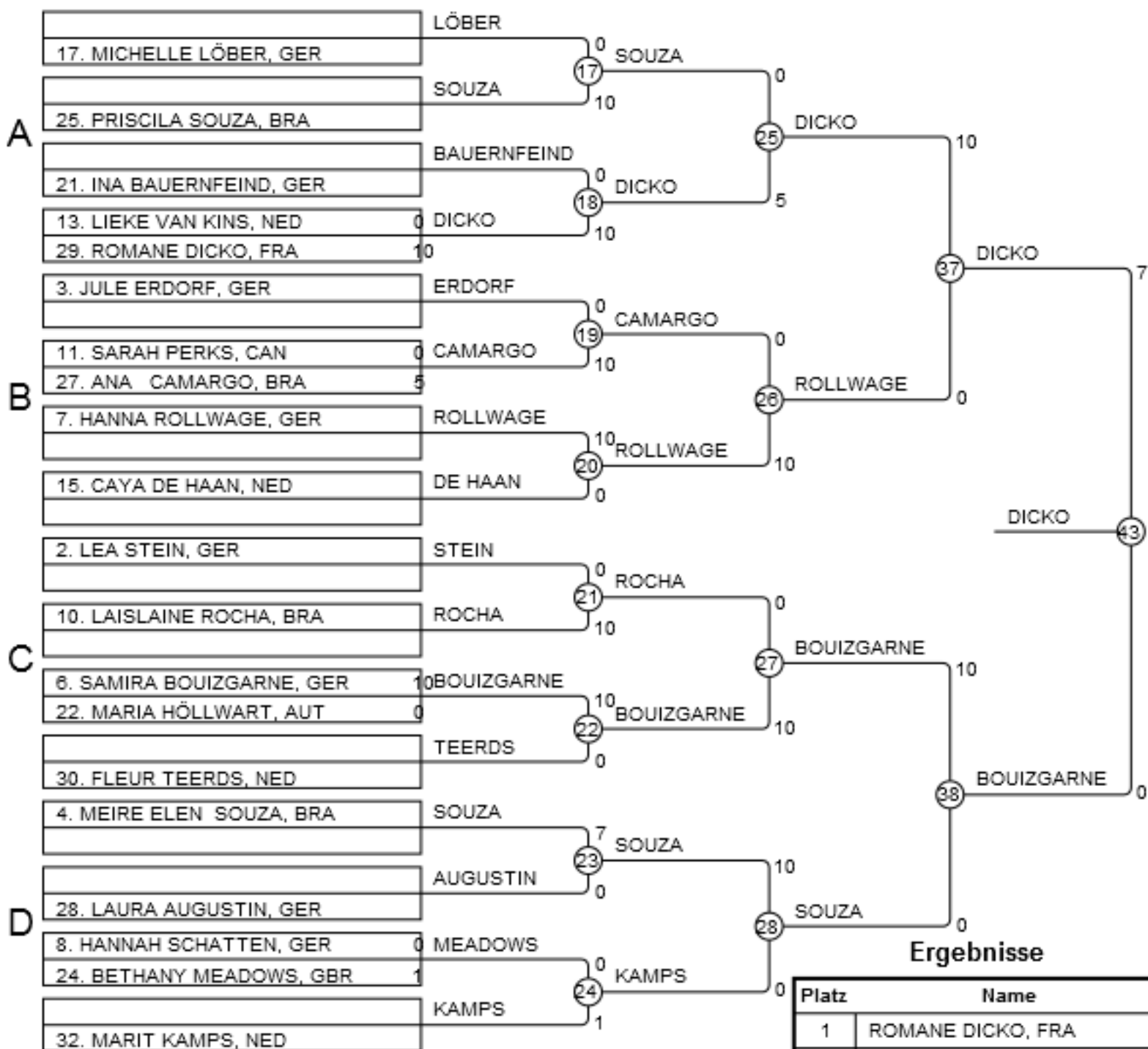

Platz	Name
1	ROMANE DICKO, FRA
2	SAMIRA BOUIZGARNE, GER
3	MEIRE ELEN SOUZA, BRA
3	HANNA ROLLWAGE, GER
5	INA BAUERNFEIND, GER
5	LAISLAINE ROCHA, BRA
7	ANA CAMARGO, BRA
7	MARIT KAMPS, NED

