



Pan-American Open Santo Domingo 2019

(DOM Santo Domingo, 6-7 September 2019)

-60 kg

19 Judoka

Pool A

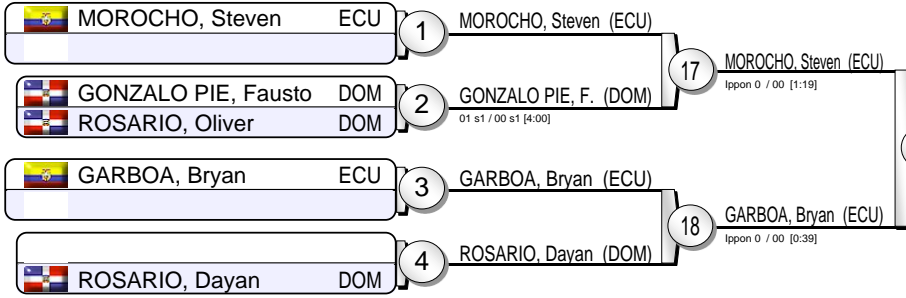

Pool B

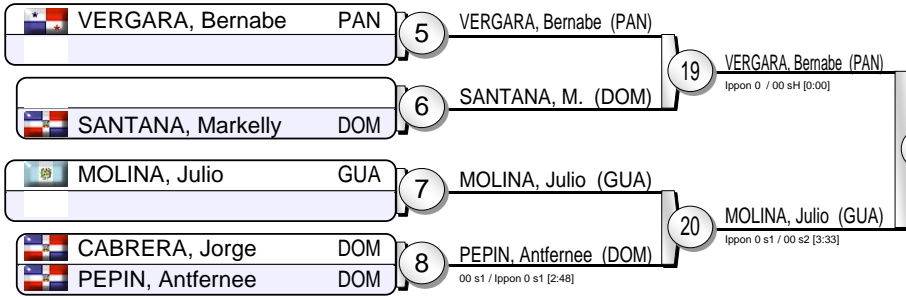

Pool C

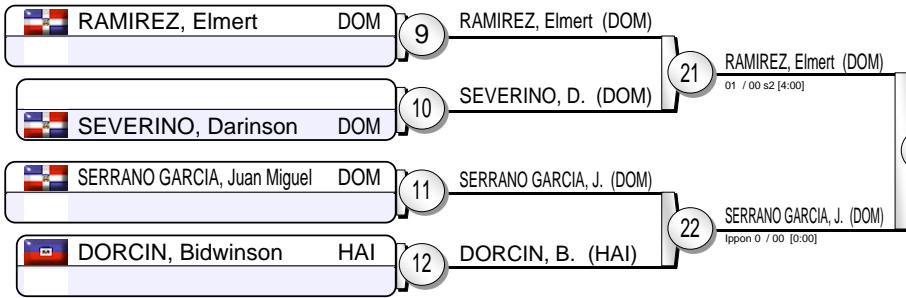

Pool D

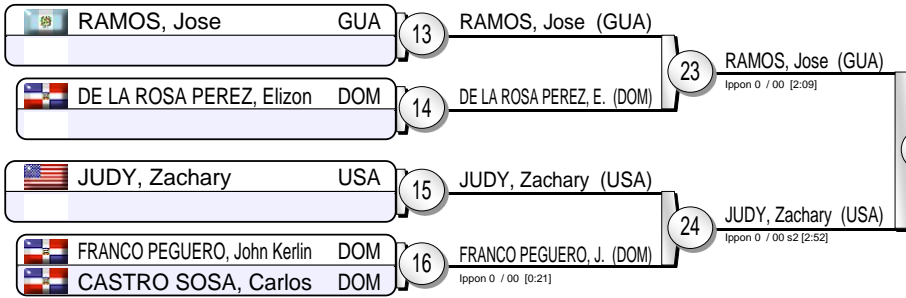

MOROCHO, Steven (ECU) 35
ippon 0 s2 / 00 s1 [2:30]

RAMIREZ, Elmert (DOM) 32
ippon 0 s1 / 00 s2 [4:00]

Results

- MOROCHO, Steven ECU
- RAMIREZ, Elmert DOM
- GARBOA, Bryan ECU
- VERGARA, Bernabe PAN
- RAMOS, Jose GUA
- SERRANO GARCIA, Juan Miguel DOM
- MOLINA, Julio GUA
- JUDY, Zachary USA

Repechage

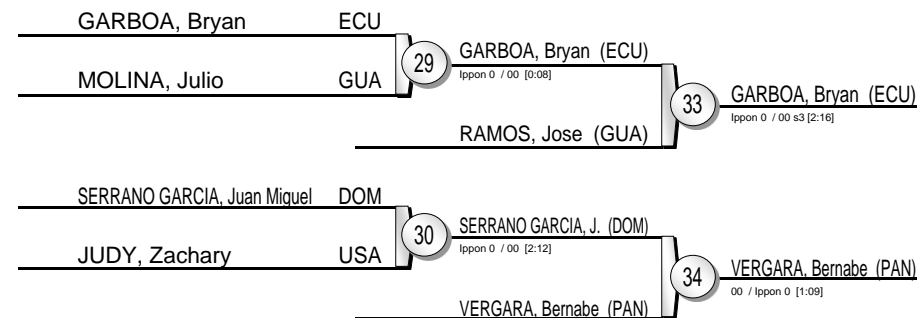



Pan-American Open Santo Domingo 2019

(DOM Santo Domingo, 6-7 September 2019)

-66 kg

18 Judoka

Pool A

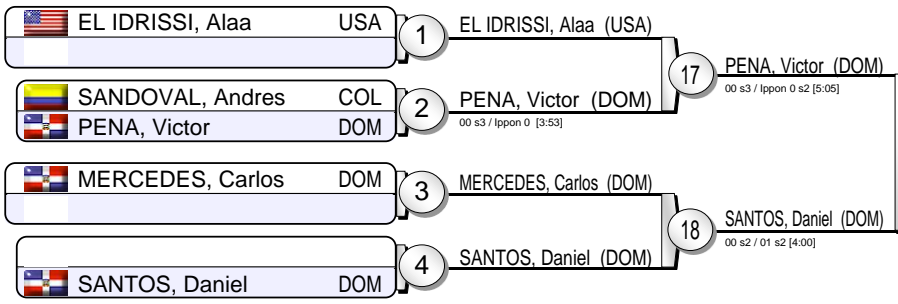

Pool B

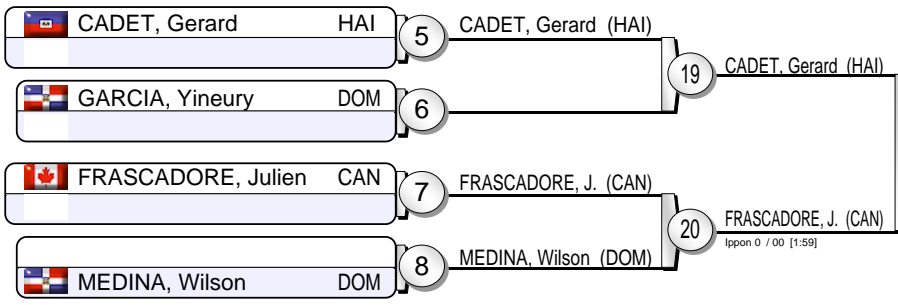

Pool C

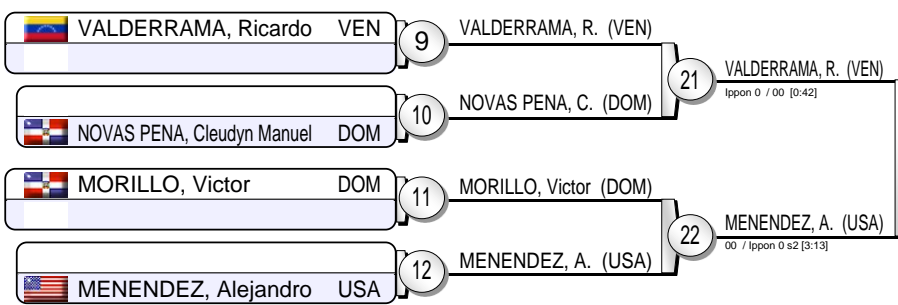

Pool D

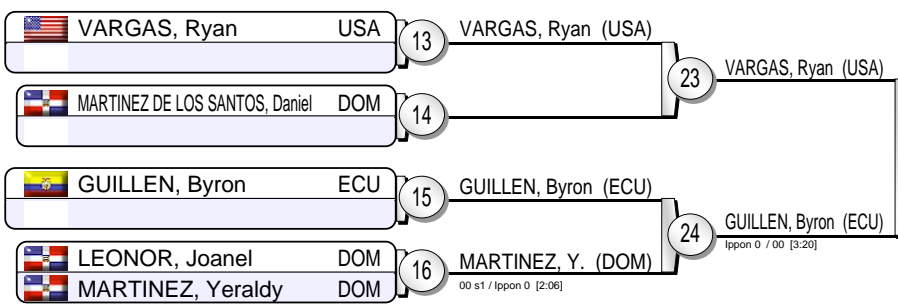

31 FRASCADORE, J. (CAN) [00 s2 / Ippon 0 [3:31]]
 26 FRASCADORE, J. (CAN) [00 / Ippon 0 s1 [2:25]]
 35 FRASCADORE, J. (CAN) [01 s2 / 00 s2 [4:32]]

Results

- FRASCADORE, Julien CAN
- VALDERRAMA, Ricardo VEN
- VARGAS, Ryan USA
- PENA, Victor DOM
- SANTOS, Daniel DOM
- MENENDEZ, Alejandro USA
- CADET, Gerard HAI
- GUILLEN, Byron ECU

Repechage

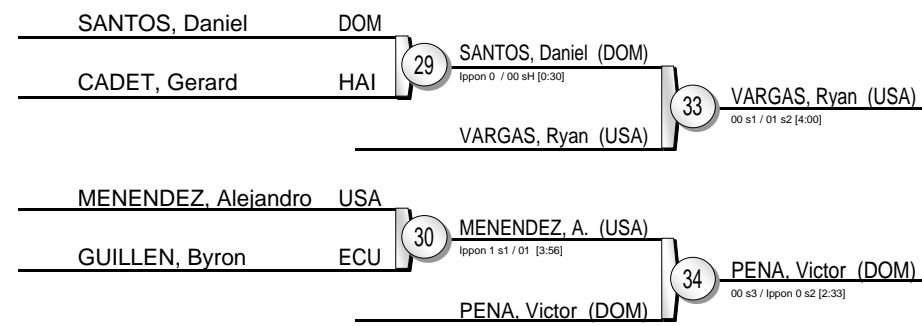



Pan-American Open Santo Domingo 2019

(DOM Santo Domingo, 6-7 September 2019)

-73 kg

17 Judoka

Pool A

CARDOSO, Gilberto	MEX	1	CARDOSO, G. (MEX)	17	CARDOSO, G. (MEX)
RAMIREZ, Stanli	DOM	2	RAMIREZ, Stanli (DOM)	17	Ippon 0 / 00 [1:17]
GERONIMO, Jose	DOM	3	GERONIMO, Jose (DOM)	18	GERONIMO, Jose (DOM)
VILMAR, Robenson	HAI	4	VILMAR, Robenson (HAI)	18	Ippon 0 / 00 [1:42]

Pool B

RUIZ, Jeffrey	PUR	5	RUIZ, Jeffrey (PUR)	19	RUIZ, Jeffrey (PUR)
ARIAS, Carlos	DOM	6	ARIAS, Carlos (DOM)	19	Ippon 0 / 00 [0:12]
ANTIC, Sava	CAN	7	ANTIC, Sava (CAN)	20	GEREZ CUELLO, O. (DOM)
GEREZ CUELLO, Orlando	DOM	8	GEREZ CUELLO, O. (DOM)	20	

Pool C

MATTEY, Sergio	VEN	9	MATTEY, Sergio (VEN)	21	MATTEY, Sergio (VEN)
GEREZ, Junior	DOM	10	GEREZ, Junior (DOM)	21	Ippon 0 s1 / 00 s1 [1:36]
LORENZO, Darvi	DOM	11	LORENZO, Darvi (DOM)	22	JUTEAU, Gabriel (CAN)
JUTEAU, Gabriel	CAN	12	JUTEAU, Gabriel (CAN)	22	00 s2 / Ippon 1 [3:06]
ROSALBERT, Roudly	HAI	12	ROSALBERT, Roudly (HAI)	22	Ippon 1 / 00 s1 [1:16]

Pool D

METELLUS, Philippe Abel	HAI	13	METELLUS, P. (HAI)	23	PEREZ, Luis (DOM)
PEREZ, Luis	DOM	14	PEREZ, Luis (DOM)	23	01 / Ippon 0 [3:58]
SALEM, Salama	USA	15	SALEM, Salama (USA)	24	PEREZ, Luis (DOM)
TORNAL, Antonio	DOM	16	TORNAL, Antonio (DOM)	24	Ippon 0 s2 / 01 s1 [4:00]
TORNAL, Antonio	DOM	16	TORNAL, Antonio (DOM)	24	00 s1 / 01 s1 [4:00]

MATTEY, Sergio (VEN) 35
00 / Ippon 1 [3:52]

MATTEY, Sergio (VEN) 32
Ippon 0 s1 / 00 [2:20]

Repechage

GERONIMO, Jose	DOM	29	GERONIMO, Jose (DOM)	33	PEREZ, Luis (DOM)
GEREZ CUELLO, Orlando	DOM	29	Ippon 1 s1 / 00 [2:43]	33	00 / Ippon 0 [0:25]
JUTEAU, Gabriel	CAN	30	JUTEAU, Gabriel (CAN)	34	CARDOSO, G. (MEX)
TORNAL, Antonio	DOM	30	Ippon 0 s1 / 00 s1 [1:26]	34	00 s1 / 01 s2 [4:00]
TORNAL, Antonio	DOM	30	TORNAL, Antonio (DOM)	34	CARDOSO, G. (MEX)

Results

- MATTEY, Sergio VEN
- RUIZ, Jeffrey PUR
- PEREZ, Luis DOM
- CARDOSO, Gilberto MEX
- GERONIMO, Jose DOM
- JUTEAU, Gabriel CAN
- GEREZ CUELLO, Orlando DOM
- TORNAL, Antonio DOM



Pan-American Open Santo Domingo 2019

(DOM Santo Domingo, 6-7 September 2019)

-81 kg

15 Judoka



Results		
1.	DEL ORBE CORTORREAL, Medickson	DOM
2.	PENA, Noel	VEN
3.	YOUNG, Keagan	CAN
3.	GUZMAN LARA, Eduardo Manuel	DOM
5.	JOHNSON, Grant	USA
5.	JACOBSON, Alex	USA
7.	WEITHERS, Asa	BAR
7.	DEEK, Ramzi	USA



Pan-American Open Santo Domingo 2019

(DOM Santo Domingo, 6-7 September 2019)

-90 kg

7 Judoka

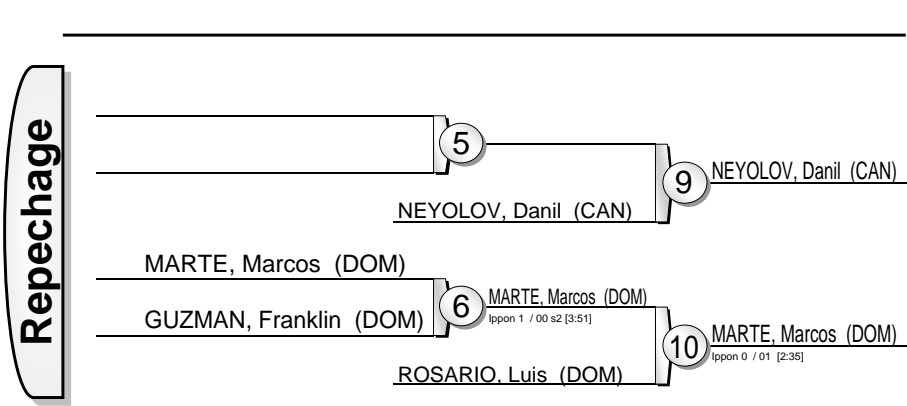
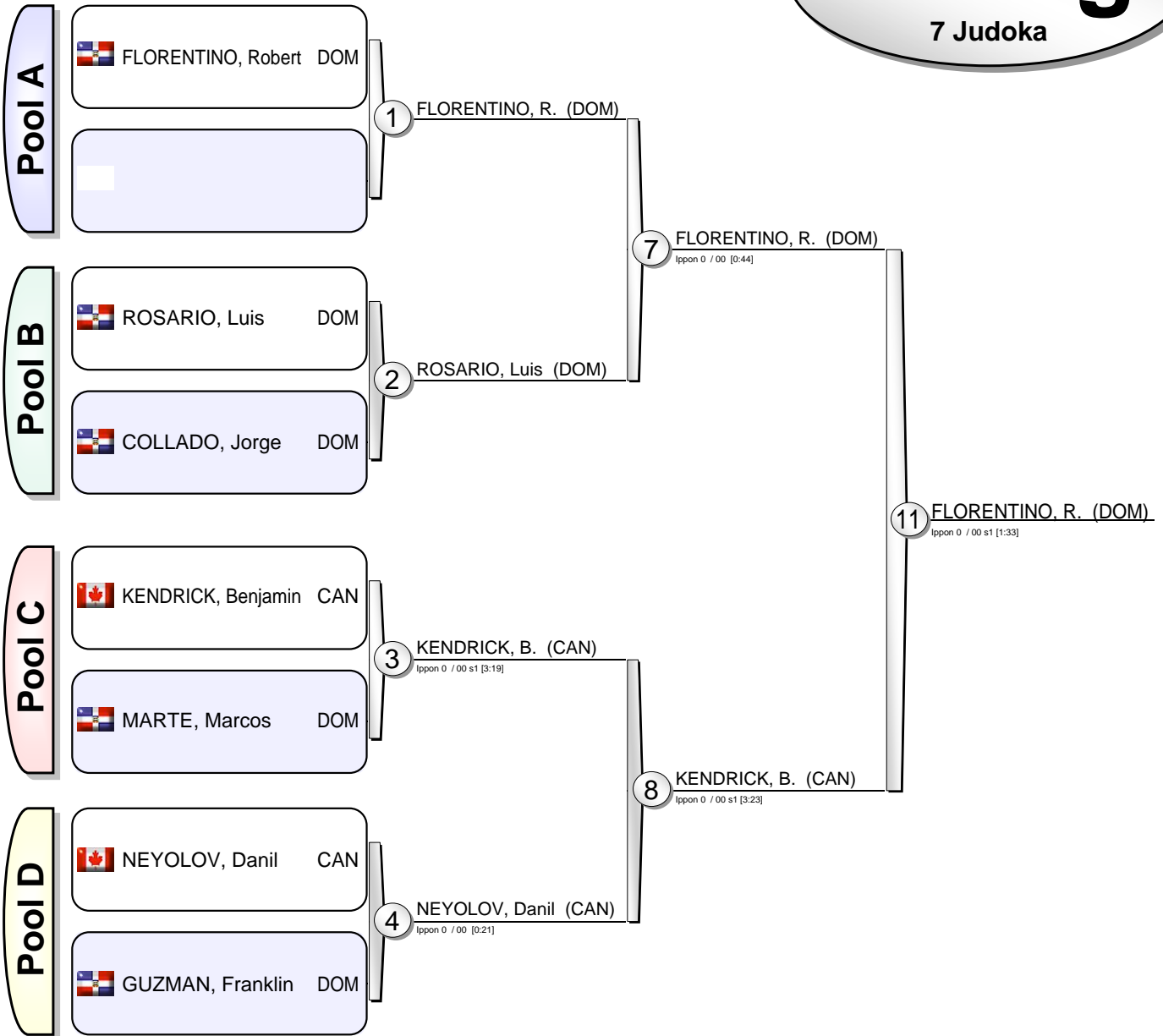

Results		
1.	FLORENTINO, Robert	DOM
2.	KENDRICK, Benjamin	CAN
3.	NEYOLOV, Danil	CAN
3.	MARTE, Marcos	DOM
5.		
5.	ROSARIO, Luis	DOM
7.		
7.	GUZMAN, Franklin	DOM



Pan-American Open Santo Domingo 2019

(DOM Santo Domingo, 6-7 September 2019)

-100 kg

5 Judoka

			1	3	5	Wins	Scores
1	KEEVE, Nathaniel	USA		+	+	2	(20)
3	MEDOS, Ivan	DOM	-		+	1	(10)
5	VINALS TEJADA, Carlos Alberto	DOM	-	-		0	(0)

			2	4	Wins	Scores
2	MEDINA, Lewis	DOM		+	1	(10)
4	PEREZ MARTINEZ, Antonio Rafael	DOM	-		0	(0)

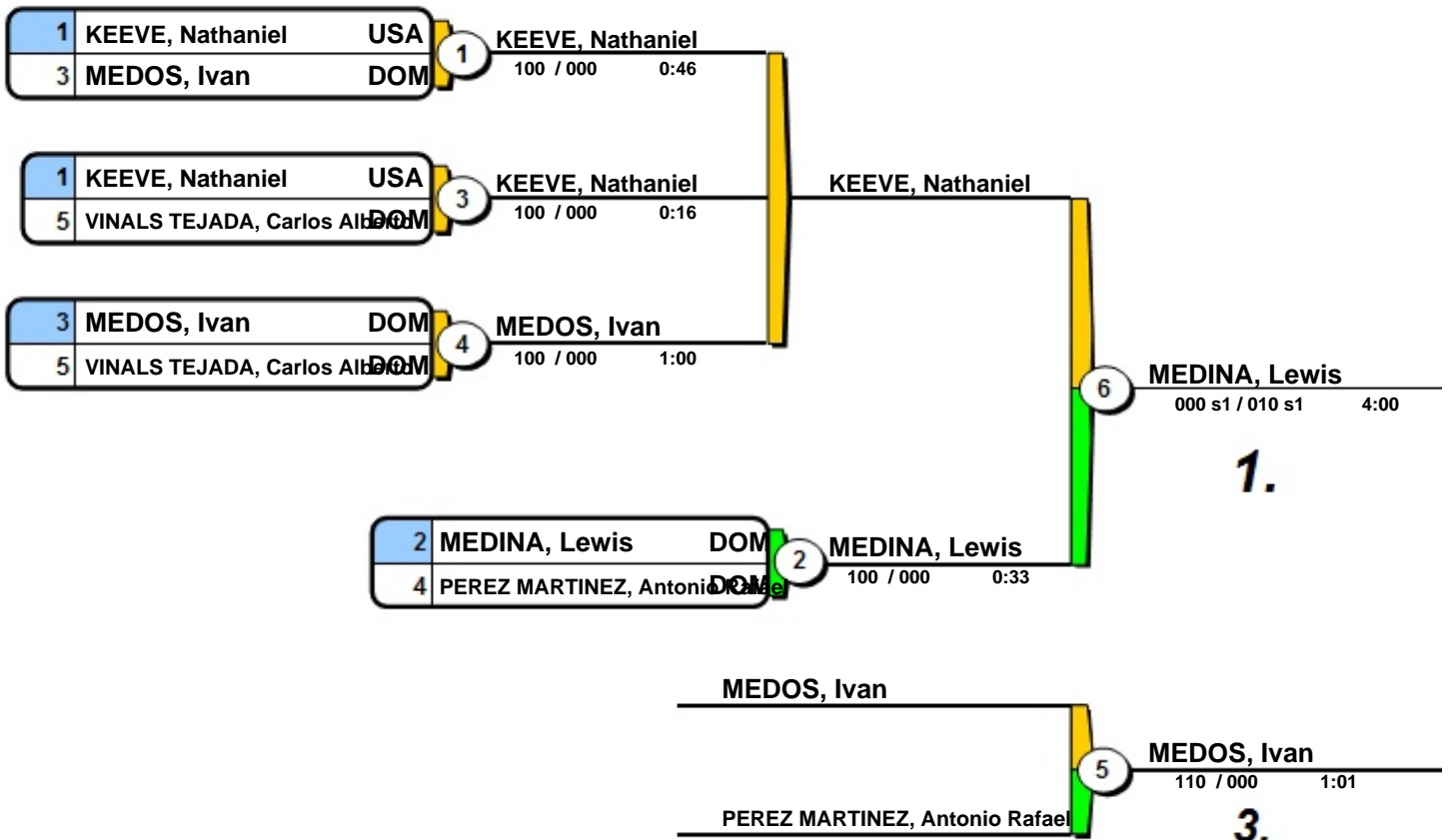

- 1. MEDINA, Lewis DOM
- 2. KEEVE, Nathaniel USA
- 3. MEDOS, Ivan DOM



Pan-American Open Santo Domingo 2019

(DOM Santo Domingo, 6-7 September 2019)

+100 kg

8 Judoka

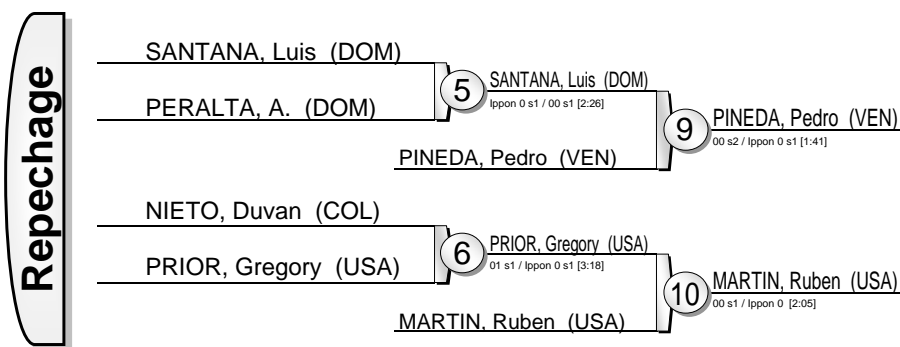
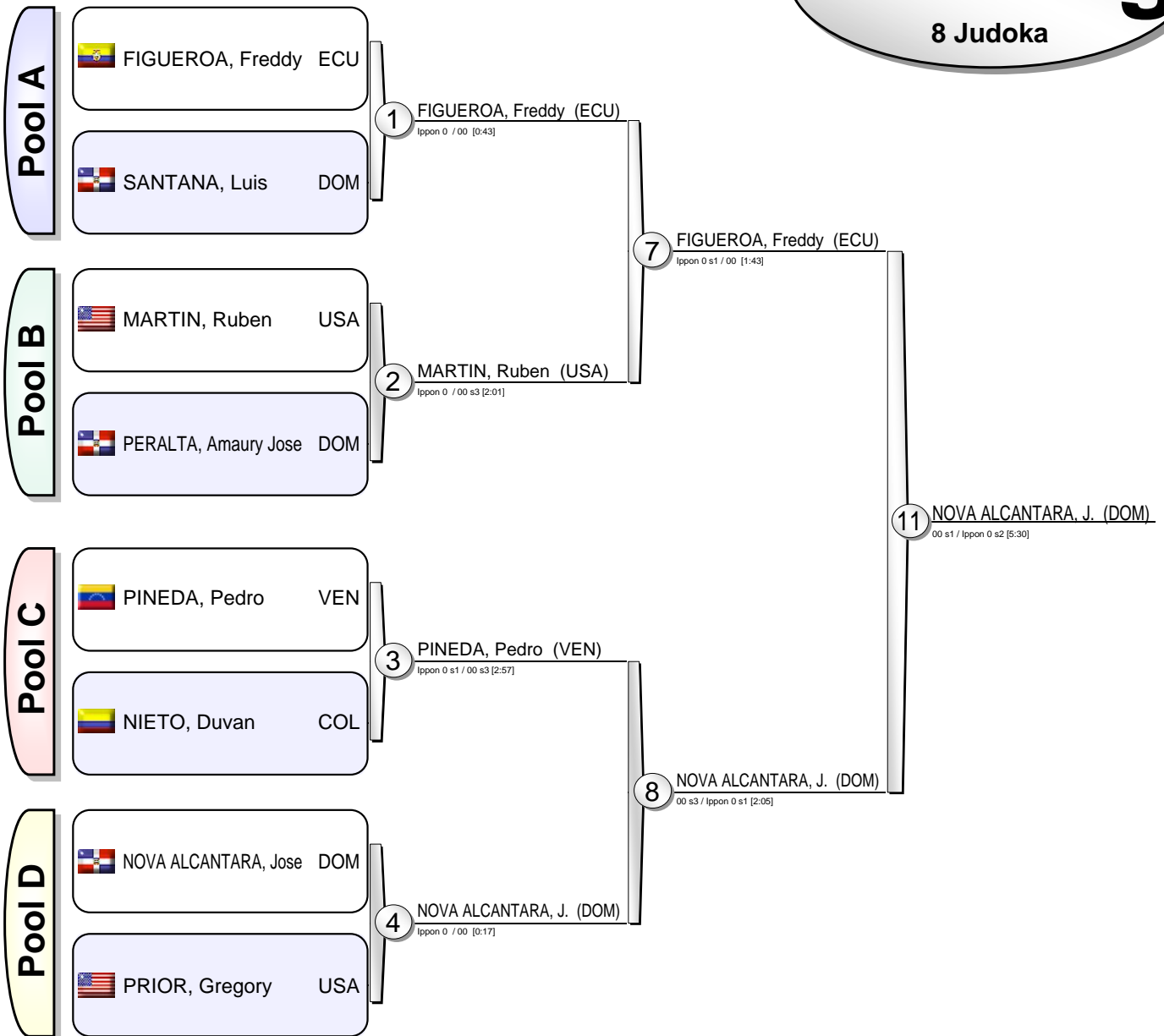

Results		
1.	NOVA ALCANTARA, Jose	DOM
2.	FIGUEROA, Freddy	ECU
3.	PINEDA, Pedro	VEN
3.	MARTIN, Ruben	USA
5.	SANTANA, Luis	DOM
5.	PRIOR, Gregory	USA
7.	PERALTA, Amaury Jose	DOM
7.	NIETO, Duvan	COL



Pan-American Open Santo Domingo 2019

(DOM Santo Domingo, 6-7 September 2019)

-48 kg

11 Judoka

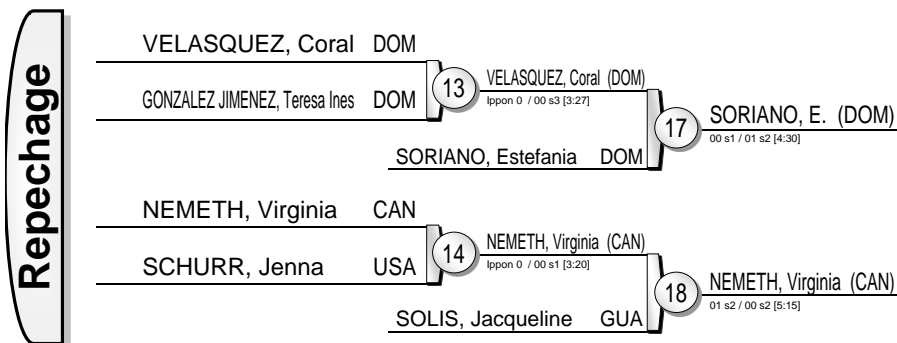

Results		
1.	ALVAREZ, Luz	COL
2.	MORAND, Priscilla	MRI
3.	SORIANO, Estefania	DOM
3.	NEMETH, Virginia	CAN
5.	VELASQUEZ, Coral	DOM
5.	SOLIS, Jacqueline	GUA
7.	GONZALEZ JIMENEZ, Teresa Ines	DOM
7.	SCHURR, Jenna	USA



Pan-American Open Santo Domingo 2019

(DOM Santo Domingo, 6-7 September 2019)

-52 kg

7 Judoka

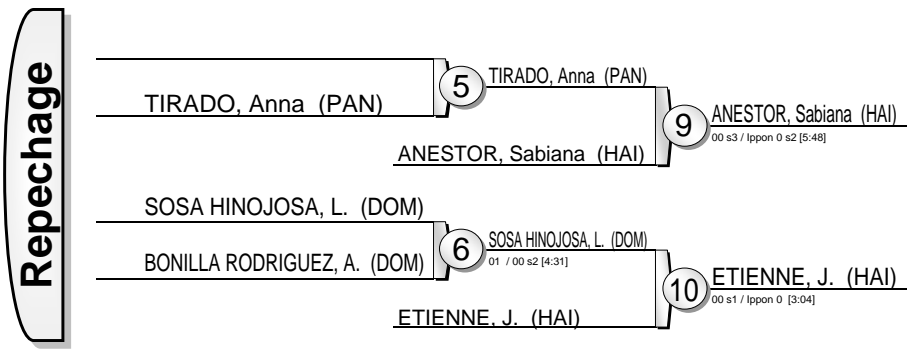
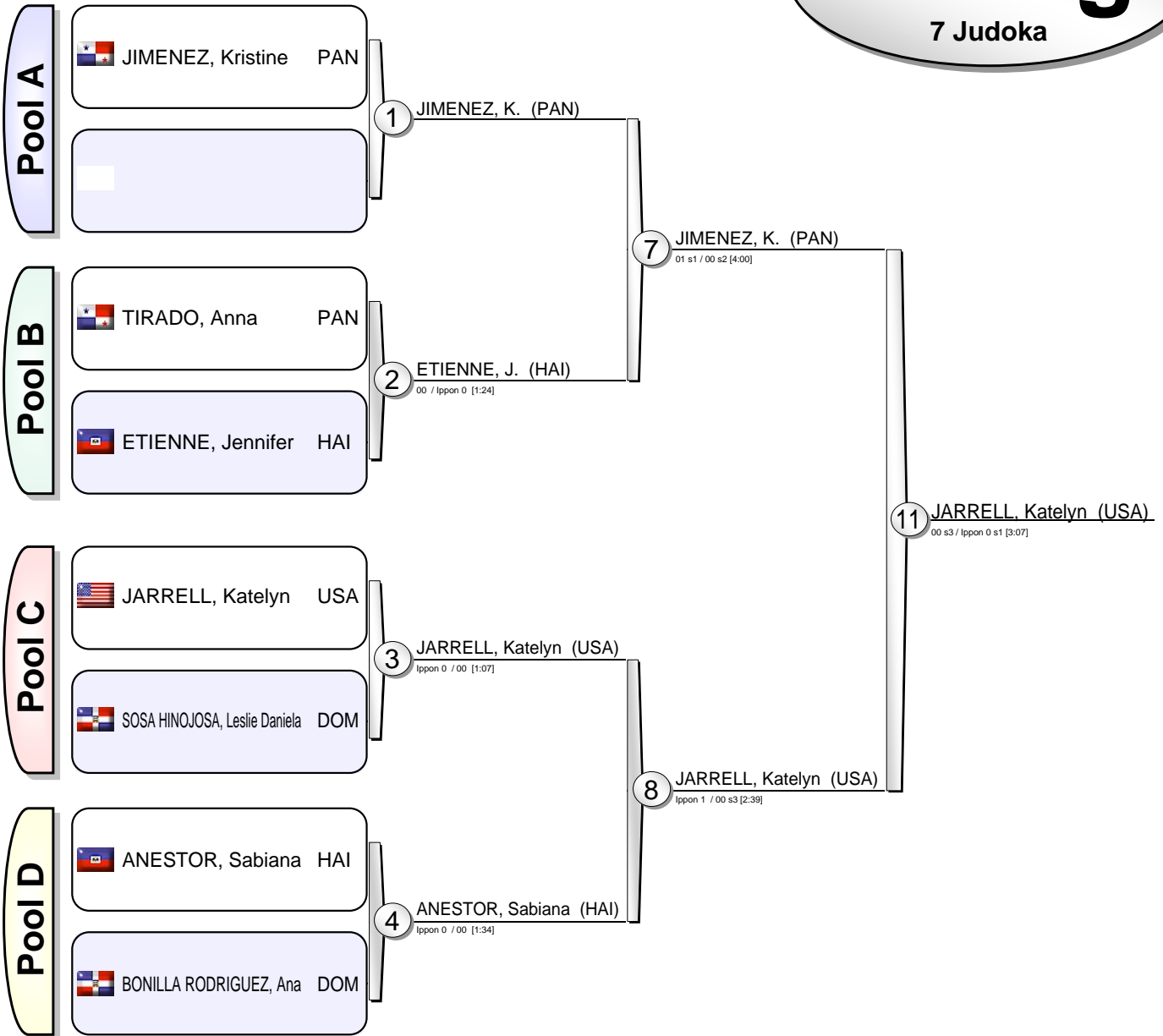

Results		
1.	JARRELL, Katelyn	USA
2.	JIMENEZ, Kristine	PAN
3.	ANESTOR, Sabiana	HAI
3.	ETIENNE, Jennifer	HAI
5.	TIRADO, Anna	PAN
5.	SOSA HINOJOSA, Leslie Daniela	DOM
7.		
7.	BONILLA RODRIGUEZ, Ana	DOM



Pan-American Open Santo Domingo 2019

(DOM Santo Domingo, 6-7 September 2019)

-57 kg

8 Judoka

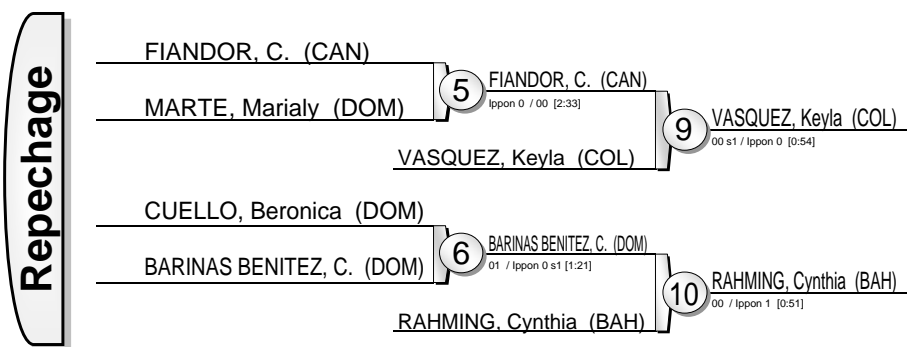
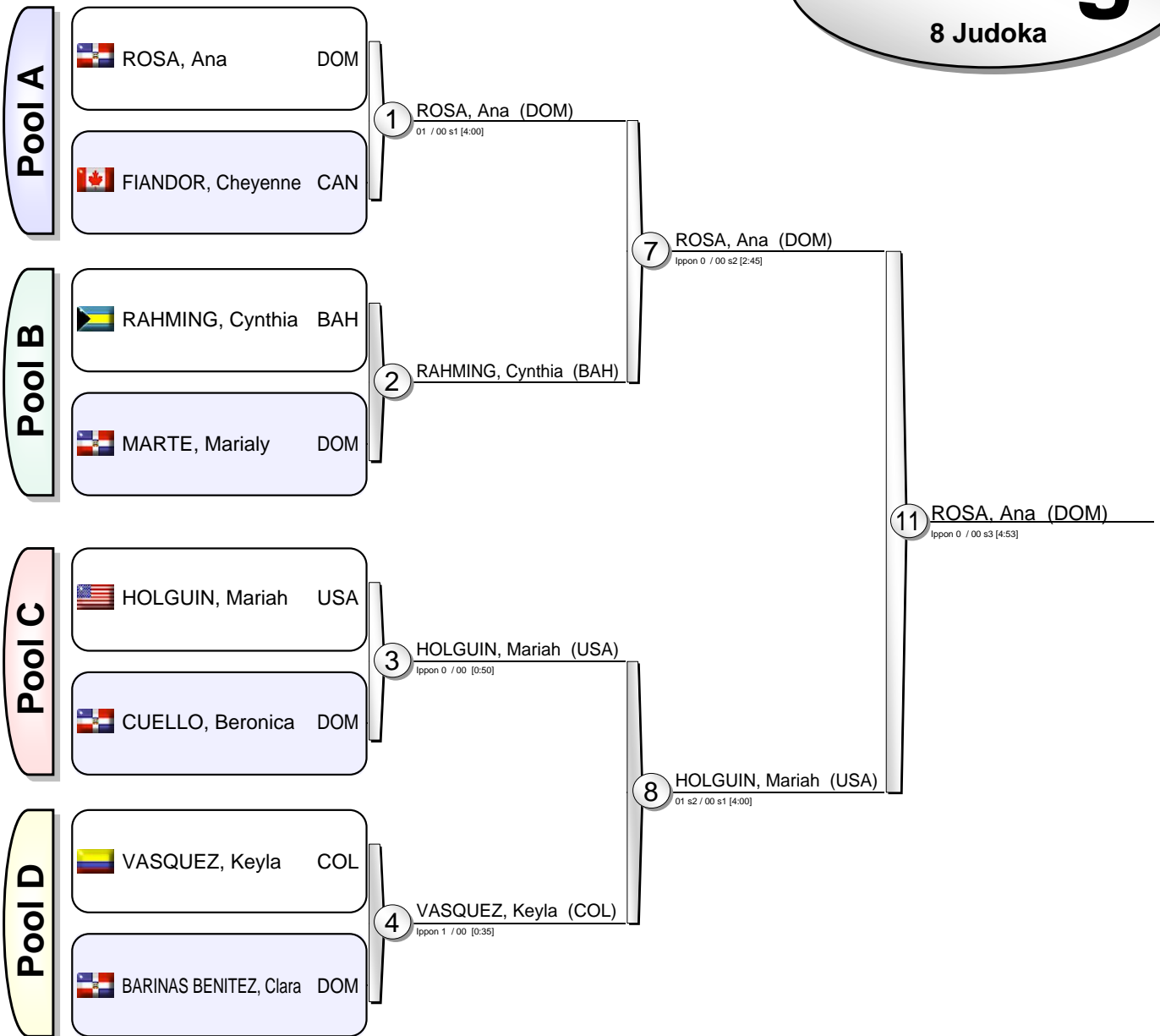

Results		
1.	ROSA, Ana	DOM
2.	HOLGUIN, Mariah	USA
3.	VASQUEZ, Keyla	COL
3.	RAHMING, Cynthia	BAH
5.	FIANDOR, Cheyenne	CAN
5.	BARINAS BENITEZ, Clara	DOM
7.	MARTE, Marialy	DOM
7.	CUELLO, Beronica	DOM



Pan-American Open Santo Domingo 2019

(DOM Santo Domingo, 6-7 September 2019)

-63 kg

10 Judoka



Results		
1.	GARCIA, Estefania	ECU
2.	WEZEU DOMBEU, Helene	CMR
3.	SANCHEZ, Ariela	DOM
3.	HARRIS, Isabelle	CAN
5.	DE SMIDT, Lauren	USA
5.	BILLIET, Sandrine	CPV
7.	BERNIER, Katherine	USA
7.	CARVAJAL ANTIGUA, Katherine	DOM



Pan-American Open Santo Domingo 2019

(DOM Santo Domingo, 6-7 September 2019)

-70 kg

5 Judoka

			1	3	5	Wins	Scores
1	SILVESTRE, Eiraima	DOM		+	-	1	(10)
3	BAUTISTA, Emely	DOM	-		+	1	(10)
5	CABRERA, Yaritza	DOM	+	-		1	(10)

			2	4	Wins	Scores
2	CORTES ALDAMA, Onix	CUB		+	1	(10)
4	CABRERA, Yaritza	DOM	-		0	(0)

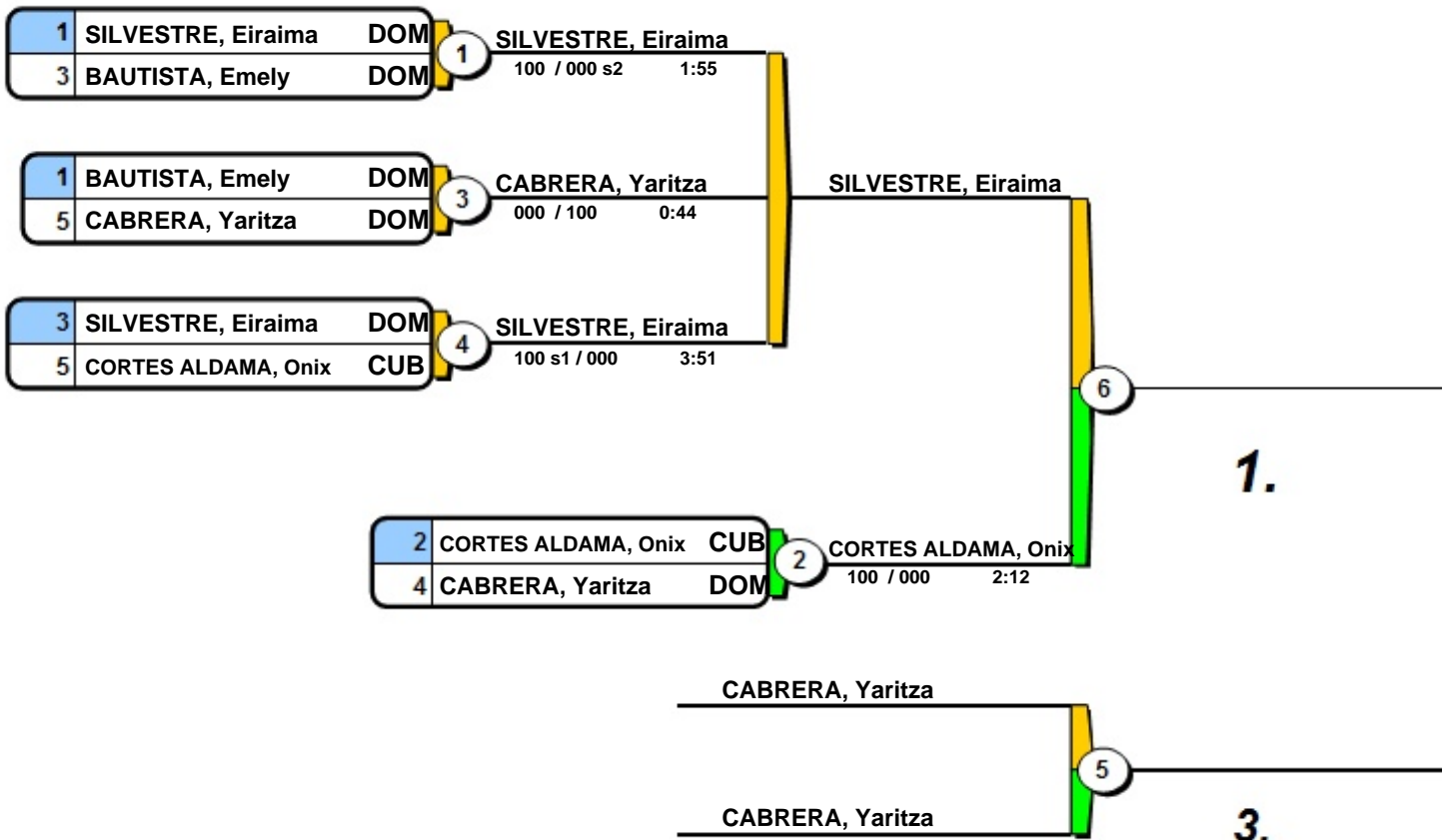

- 1.
- 2.
- 3.



Pan-American Open Santo Domingo 2019

(DOM Santo Domingo, 6-7 September 2019)

-78 kg

4 Judoka

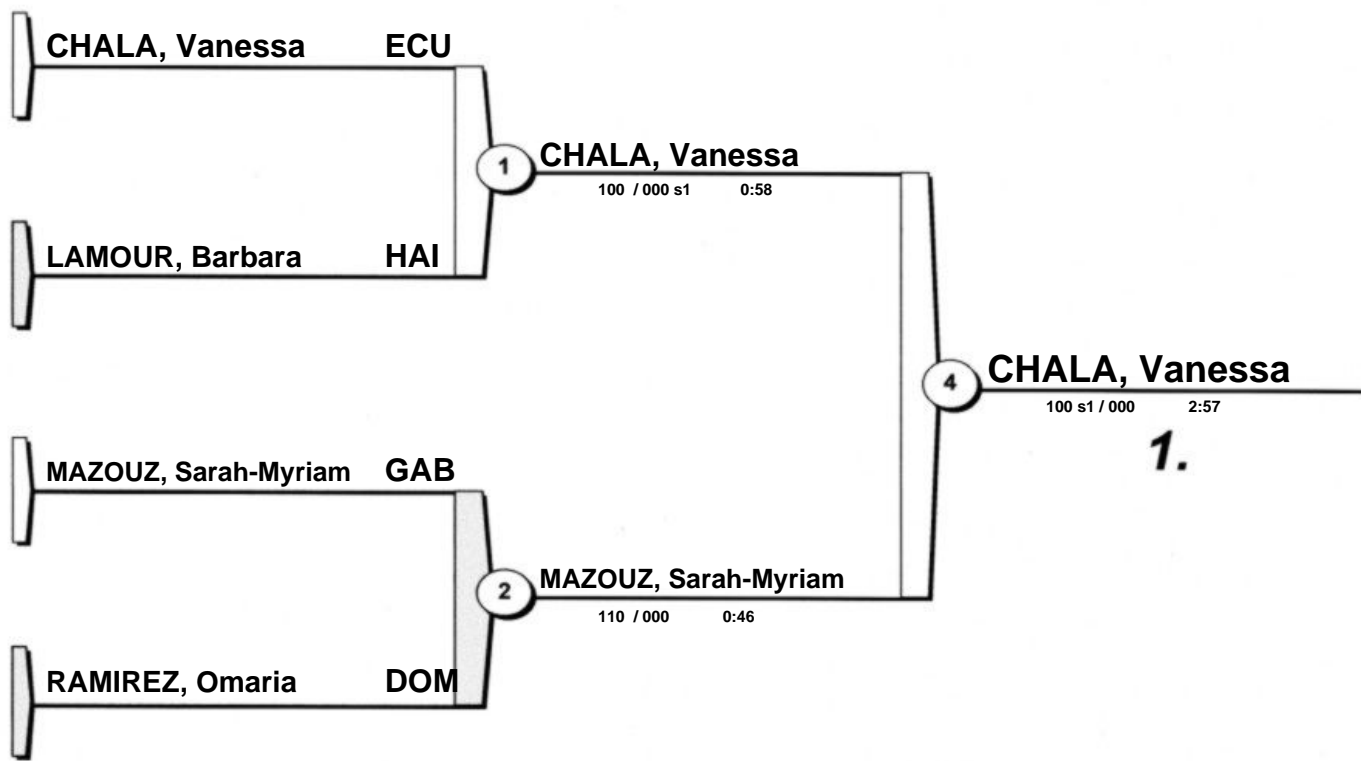

LAMOUR, Barbara

RAMIREZ, Omaria

000 s3 / 100 1:03

RAMIREZ, Omaria

1. CHALA, Vanessa ECU
2. MAZOUZ, Sarah-Myriam GAB
3. RAMIREZ, Omaria DOM



Pan-American Open Santo Domingo 2019

(DOM Santo Domingo, 6-7 September 2019)

+78 kg

5 Judoka

	1	3	5	Wins	Scores
1 MORILLO, Moira DOM		+	-	1	(10)
3 DIAZ ALBURQUERQUE, Laura DOM	-		+	1	(10)
5 MATEO RAMIREZ, Flor Maria DOM	+	-		1	(10)

	2	4	Wins	Scores
2 MOJICA, Melissa PUR		+	1	(10)
4 MATEO RAMIREZ, Flor Maria DOM	-		0	(0)

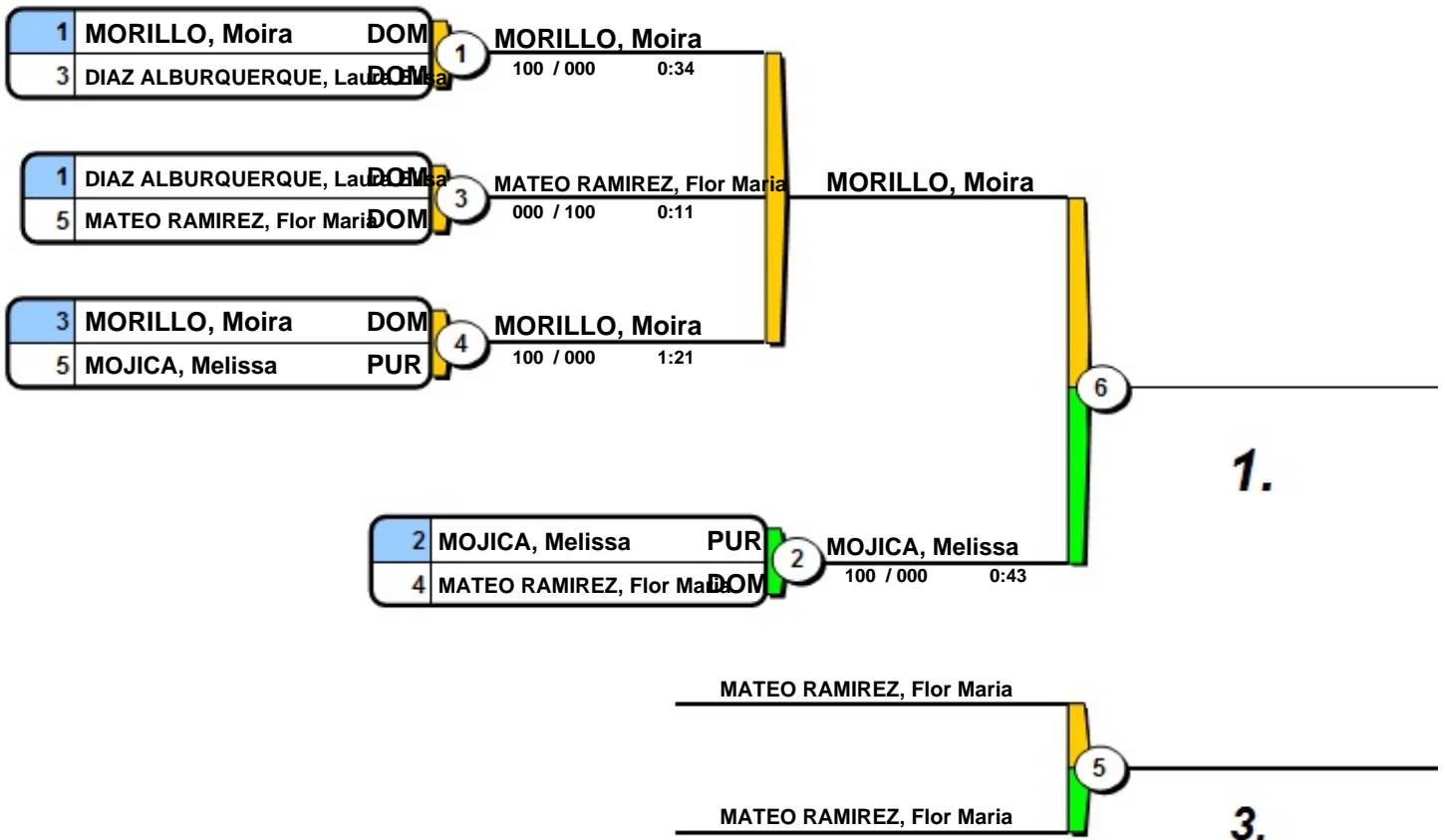

- 1.
- 2.
- 3.