



Pan-American Open Santo Domingo 2018

(DOM Santo Domingo, 1-2 September 2018)

-60 kg

17 Judoka

Pool A

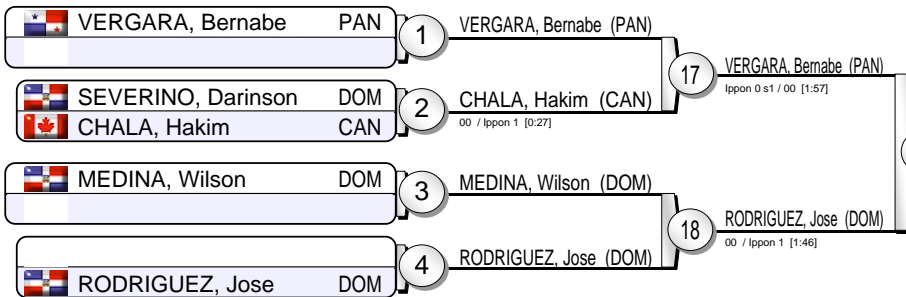

Pool B

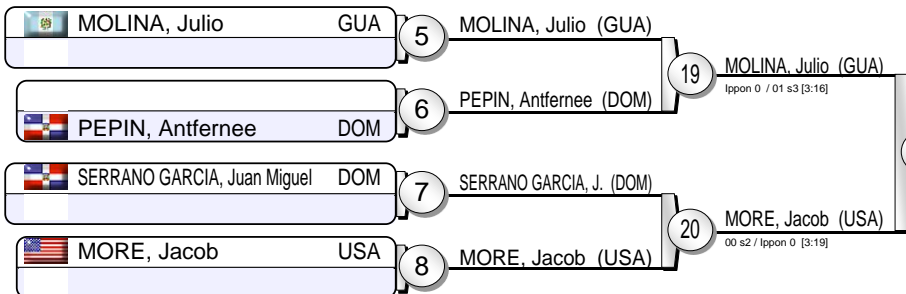

Pool C

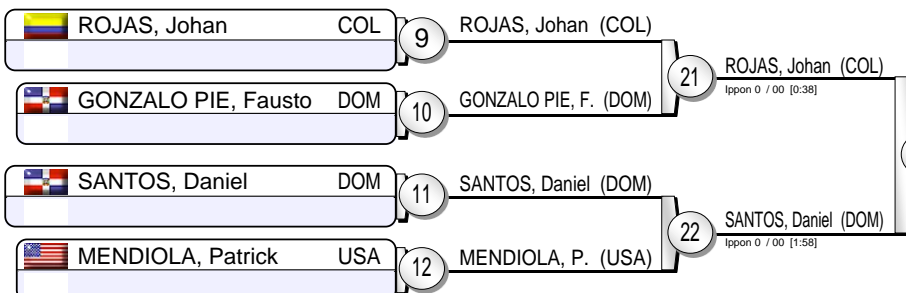

Pool D

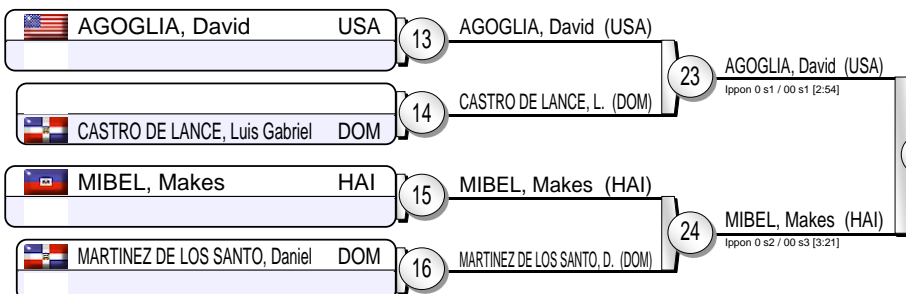

MOLINA, Julio (GUA) 35

Results

- MOLINA, Julio GUA
- AGOGLIA, David USA
- ROJAS, Johan COL
- SANTOS, Daniel DOM
- RODRIGUEZ, Jose DOM
- VERGARA, Bernabe PAN
- MORE, Jacob USA
- MIBEL, Makes HAI

Repechage

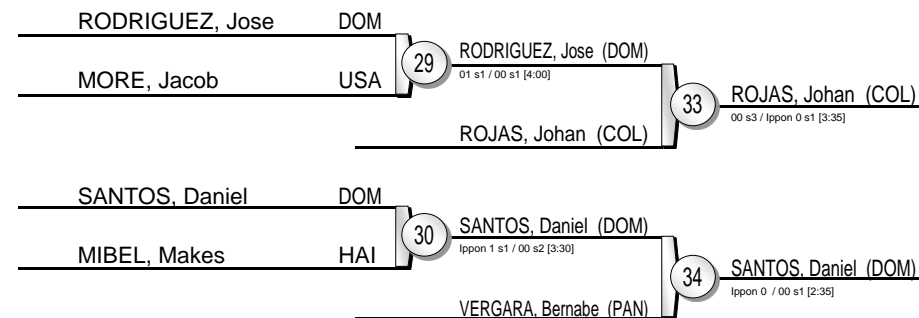



Pan-American Open Santo Domingo 2018

(DOM Santo Domingo, 1-2 September 2018)

-66 kg

16 Judoka

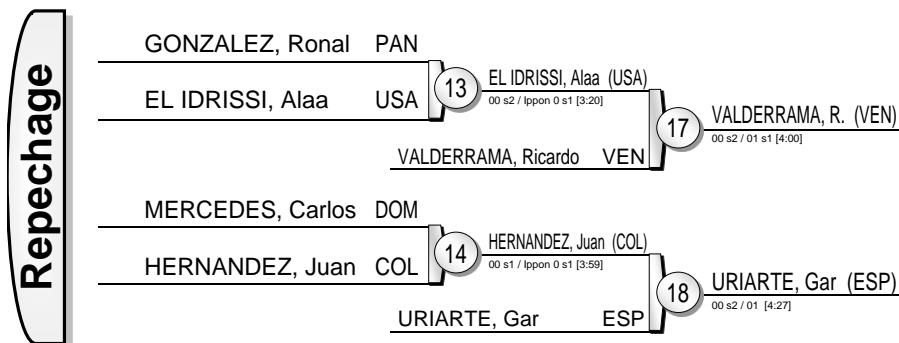

Results		
1.	MATEO, Wander	DOM
2.	POSTIGOS, Juan	PER
3.	VALDERRAMA, Ricardo	VEN
3.	URIARTE, Gar	ESP
5.	EL IDRISSI, Alaa	USA
5.	HERNANDEZ, Juan	COL
7.	GONZALEZ, Ronal	PAN
7.	MERCEDES, Carlos	DOM



Pan-American Open Santo Domingo 2018

(DOM Santo Domingo, 1-2 September 2018)

-73 kg

16 Judoka

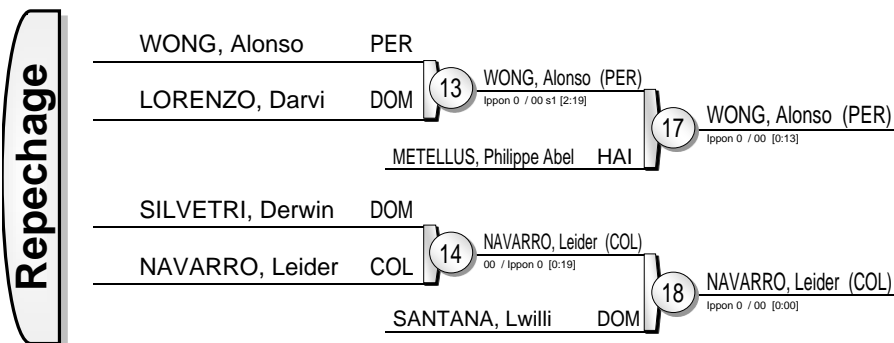

Results		
1.	RUIZ, Jeffrey	PUR
2.	WRIGHT, Liam	USA
3.	WONG, Alonso	PER
3.	NAVARRO, Leider	COL
5.	METELLUS, Philippe Abel	HAI
5.	SANTANA, Lwilli	DOM
7.	LORENZO, Darvi	DOM
7.	SILVETRI, Derwin	DOM



Pan-American Open Santo Domingo 2018

(DOM Santo Domingo, 1-2 September 2018)

-81 kg

18 Judoka

Pool A

HATTON, Jack USA	1	HATTON, Jack (USA)	17	GAUTHIER DRAPEAU, F. (CAN) 00 s3 / Ippon 0 [2:57]
GAUTHIER DRAPEAU, Francois CAN	2	GAUTHIER DRAPEAU, F. (CAN) Ippon 0 s1 / 00 [2:15]		
CORTES, Carlos CRC				
RODRIGUEZ, Fabian PUR	3	RODRIGUEZ, F. (PUR)	18	RODRIGUEZ, F. (PUR) Ippon 0 / 00 [0:58]
DE LOS SANTOS, Jose DOM	4	DE LOS SANTOS, J. (DOM)		

25 GAUTHIER DRAPEAU, F. (CAN)
Ippon 0 / 01 s1 [3:26]

31 GAUTHIER DRAPEAU, F. (CAN)
Ippon 0 / 00 [0:59]

Pool B

MARTIN, Ruben USA	5	MARTIN, Ruben (USA)	19	MARTIN, Ruben (USA) 01 s2 / 00 s1 [4:00]
PIMENTEL PEREZ, Wilrly DOM	6	PIMENTEL PEREZ, W. (DOM)		
WRIGHT, Arthur USA	7	WRIGHT, Arthur (USA)	20	WRIGHT, Arthur (USA) Ippon 0 / 00 [1:35]
MARTE, Marcos DOM	8	MARTE, Marcos (DOM)		

26 WRIGHT, Arthur (USA)
00 s1 / Ippon 0 [1:58]

35 DEL ORBE CORTORREAL, M. (DOM)
00 / Ippon 0 [0:45]

Pool C

DEL ORBE CORTORREAL, Medickson DOM	9	DEL ORBE CORTORREAL, M. (DOM)	21	DEL ORBE CORTORREAL, M. (DOM) Ippon 0 / 00 s1 [1:58]
JACOBSON, Alex USA	10	JACOBSON, Alex (USA)		
ANGELES SOTELO, Luis PER	11	ANGELES SOTELO, L. (PER)	22	ANGELES SOTELO, L. (PER) Ippon 0 s1 / 00 s3 [4:32]
WEST, Gregory USA	12	WEST, Gregory (USA)		

27 DEL ORBE CORTORREAL, M. (DOM)
Ippon 0 / 00 s2 [2:48]

32 DEL ORBE CORTORREAL, M. (DOM)
Ippon 0 s1 / 00 [1:56]

Pool D

MARINEAU, Alex CAN	13	MARINEAU, Alex (CAN)	23	MARINEAU, Alex (CAN) Ippon 0 / 00 s1 [1:33]
SANTANA, Oscar DOM	14	SANTANA, Oscar (DOM) Ippon 0 / 01 [2:17]		
WEITHERS, Asa BAR				
HERRERO, Igor ESP	15	HERRERO, Igor (ESP)	24	HERRERO, Igor (ESP) Ippon 0 / 00 s1 [1:03]
JOHNSON, Grant USA	16	JOHNSON, Grant (USA)		

28 HERRERO, Igor (ESP)
00 s3 / Ippon 1 [2:41]

Repechage

RODRIGUEZ, Fabian PUR	29	MARTIN, Ruben (USA) 00 / Ippon 0 s1 [1:34]	33	HERRERO, Igor (ESP) 00 s1 / 01 s1 [4:00]
MARTIN, Ruben USA				
ANGELES SOTELO, Luis PER	30	ANGELES SOTELO, L. (PER) Ippon 0 / 00 s1 [3:48]	34	ANGELES SOTELO, L. (PER) Ippon 0 / 00 s3 [6:41]
MARINEAU, Alex CAN				
				WRIGHT, Arthur (USA)

Results

- DEL ORBE CORTORREAL, Medickson DOM
- GAUTHIER DRAPEAU, Francois CAN
- HERRERO, Igor ESP
- ANGELES SOTELO, Luis PER
- MARTIN, Ruben USA
- WRIGHT, Arthur USA
- RODRIGUEZ, Fabian PUR
- MARINEAU, Alex CAN



Pan-American Open Santo Domingo 2018

(DOM Santo Domingo, 1-2 September 2018)

-90 kg

11 Judoka

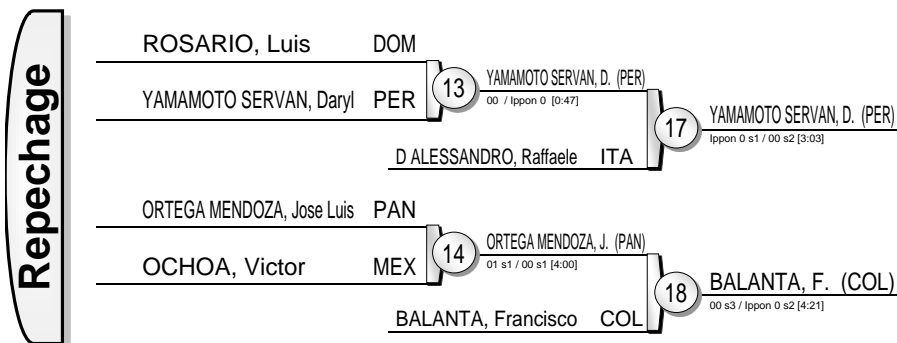

- ## Results
1. FLORENTINO, Robert DOM
 2. BROWN, Colton USA
 3. YAMAMOTO SERVAN, Daryl PER
 3. BALANTA, Francisco COL
 5. D ALESSANDRO, Raffaele ITA
 5. ORTEGA MENDOZA, Jose Luis PAN
 7. ROSARIO, Luis DOM
 7. OCHOA, Victor MEX



Pan-American Open Santo Domingo 2018

(DOM Santo Domingo, 1-2 September 2018)

-100 kg

7 Judoka

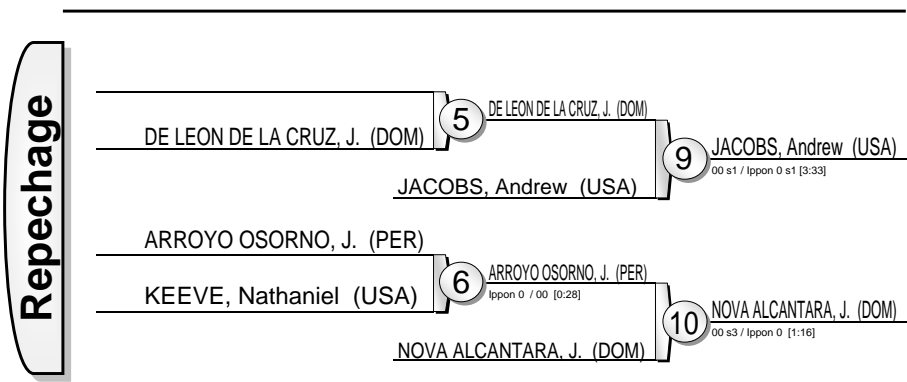
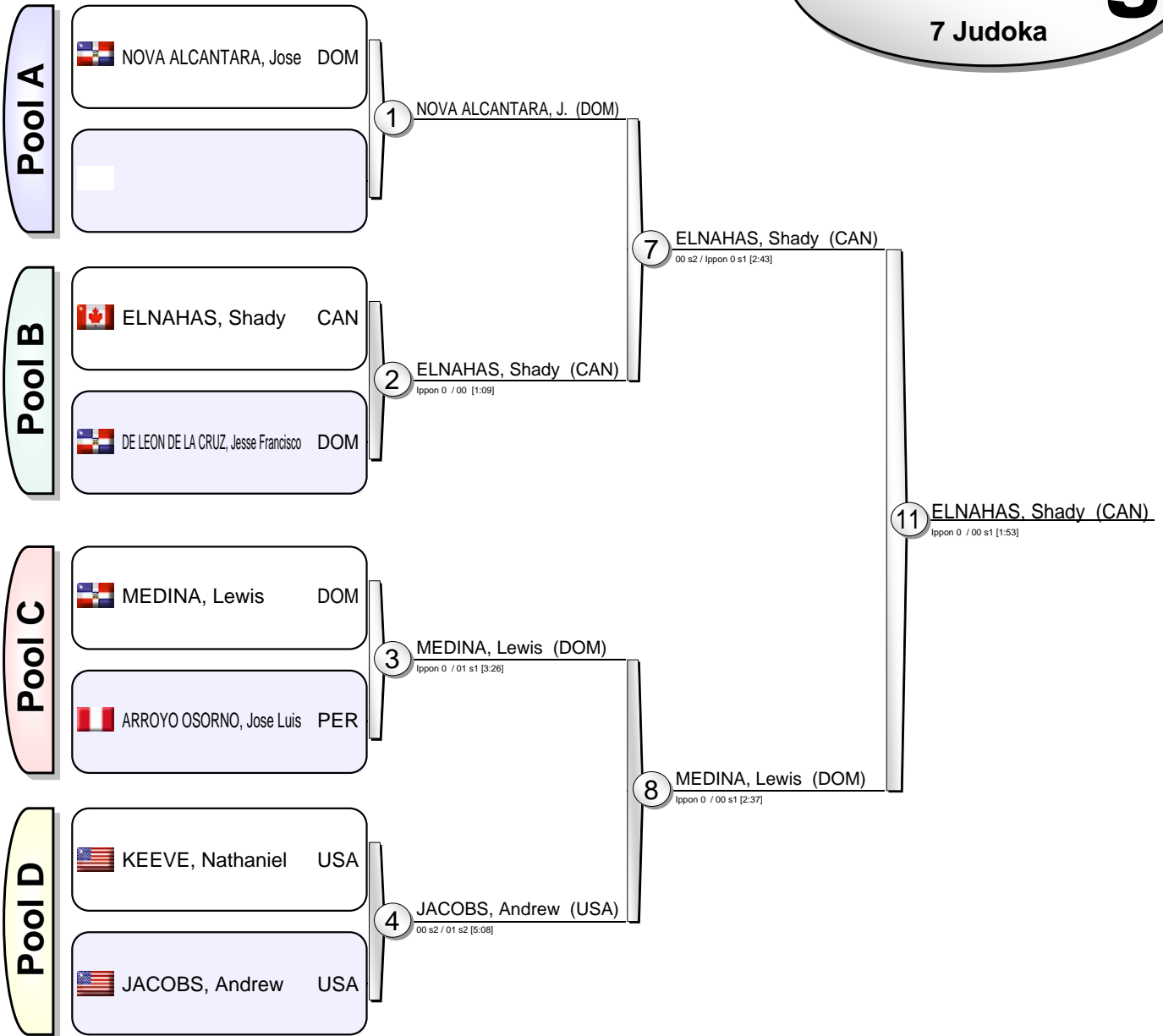

Results		
1.	ELNAHAS, Shady	CAN
2.	MEDINA, Lewis	DOM
3.	JACOBS, Andrew	USA
3.	NOVA ALCANTARA, Jose	DOM
5.	DE LEON DE LA CRUZ, Jesse Francisco	DOM
5.	ARROYO OSORNO, Jose Luis	PER
7.		
7.	KEEVE, Nathaniel	USA



Pan-American Open Santo Domingo 2018

(DOM Santo Domingo, 1-2 September 2018)

+100 kg

5 Judoka

			1	3	5	Wins	Scores
1	PINEDA, Pedro	VEN		+	+	2	(20)
3	PERALTA, Amaury Jose	DOM	-		-	0	(0)
5	GAUTHIER, Kevin	CAN	-	+		1	(7)

			2	4	Wins	Scores
2	CHELARU GRIGORAS, Irinel Vasile	ESP		+	1	(10)
4	SANTANA, Luis	DOM	-		0	(0)

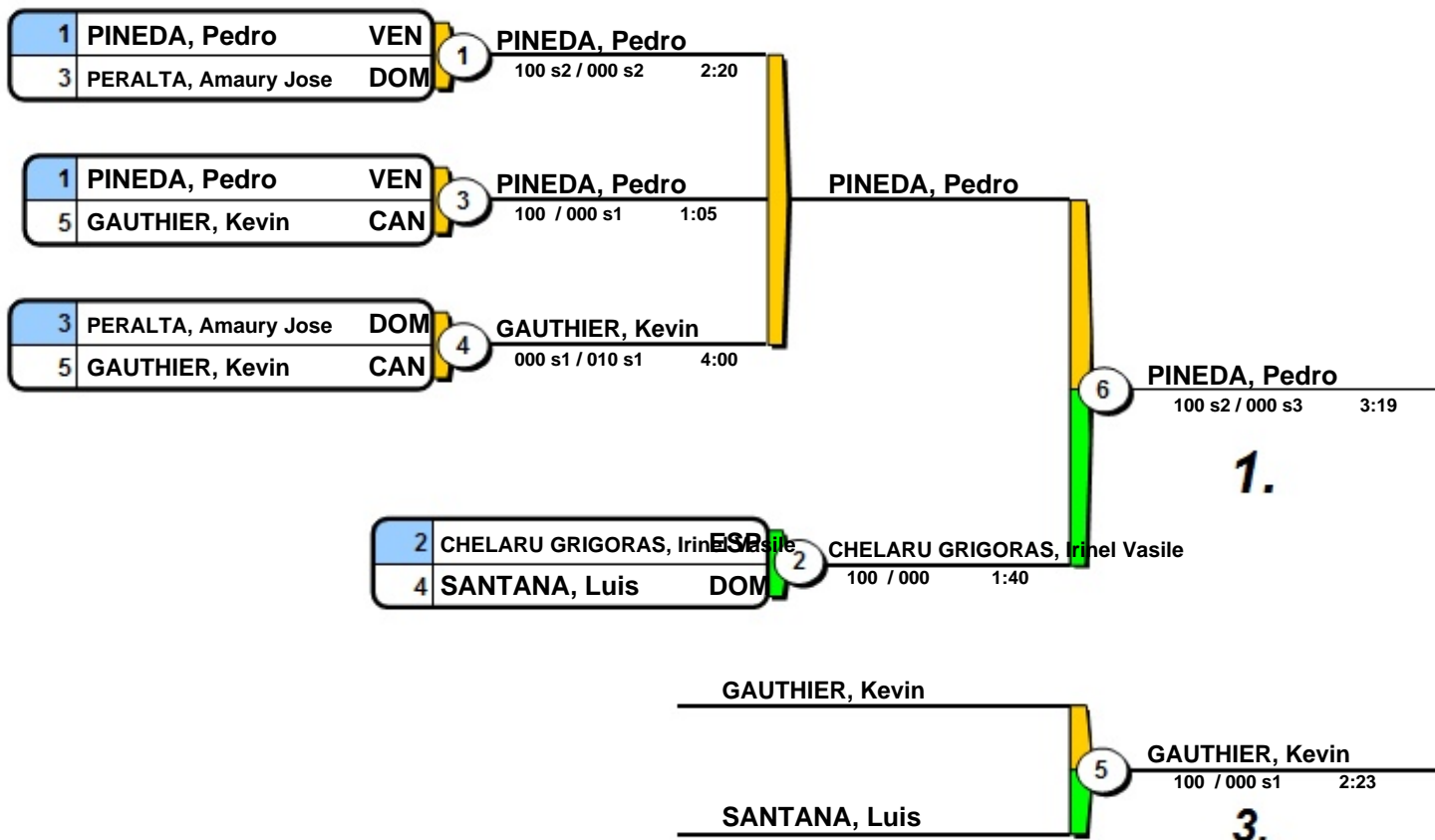

- 1. PINEDA, Pedro VEN
- 2. CHELARU GRIGORAS, Irinel Vasile ESP
- 3. GAUTHIER, Kevin CAN



Pan-American Open Santo Domingo 2018

(DOM Santo Domingo, 1-2 September 2018)

-48 kg

10 Judoka

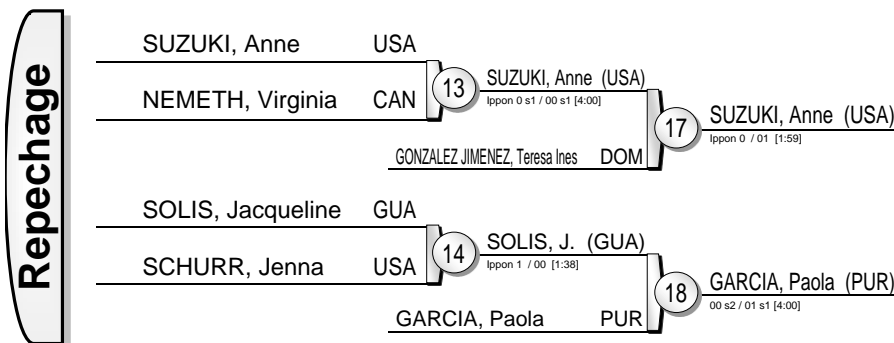

Results		
1.	SORIANO, Estefania	DOM
2.	MORAND, Priscilla	MRI
3.	SUZUKI, Anne	USA
3.	GARCIA, Paola	PUR
5.	GONZALEZ JIMENEZ, Teresa Ines	DOM
5.	SOLIS, Jacqueline	GUA
7.	NEMETH, Virginia	CAN
7.	SCHURR, Jenna	USA



Pan-American Open Santo Domingo 2018

(DOM Santo Domingo, 1-2 September 2018)

-52 kg

9 Judoka

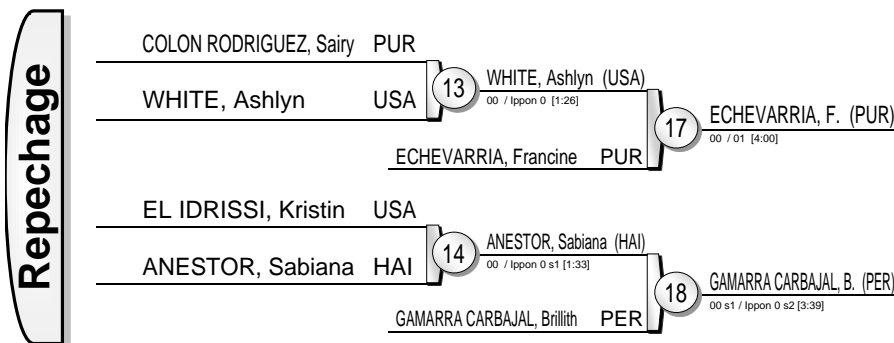

Results		
1.	BESSON, Marie	CAN
2.	ABUAN, Alaine	USA
3.	ECHEVARRIA, Francine	PUR
3.	GAMARRA CARBAJAL, Brillith	PER
5.	WHITE, Ashlyn	USA
5.	ANESTOR, Sabiana	HAI
7.	COLON RODRIGUEZ, Sairy	PUR
7.	EL IDRISSE, Kristin	USA



Pan-American Open Santo Domingo 2018

(DOM Santo Domingo, 1-2 September 2018)

-57 kg

13 Judoka



Results		
1.	MACHADO, Wisneybi	VEN
2.	ROSA, Ana	DOM
3.	JIMENEZ, Luisa	DOM
3.	HOLGUIN, Mariah	USA
5.	RAHMING, Cynthia	BAH
5.	FULGENTES, Amelia	USA
7.	PITSILIS, Camelia	CAN
7.	FRIEDLANDER, Isadora	USA



Pan-American Open Santo Domingo 2018

(DOM Santo Domingo, 1-2 September 2018)

-63 kg

8 Judoka

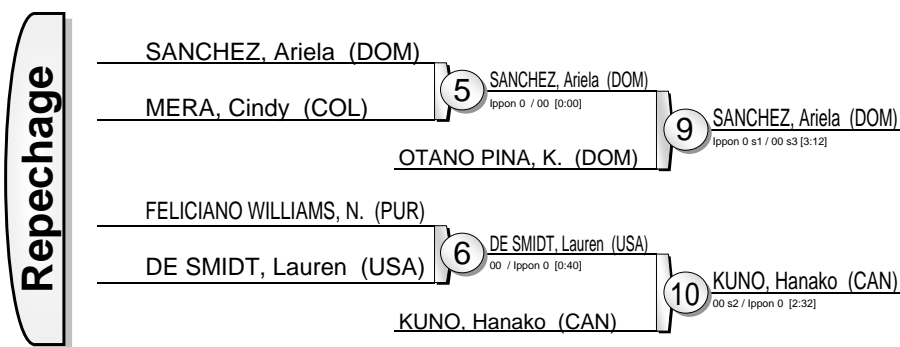
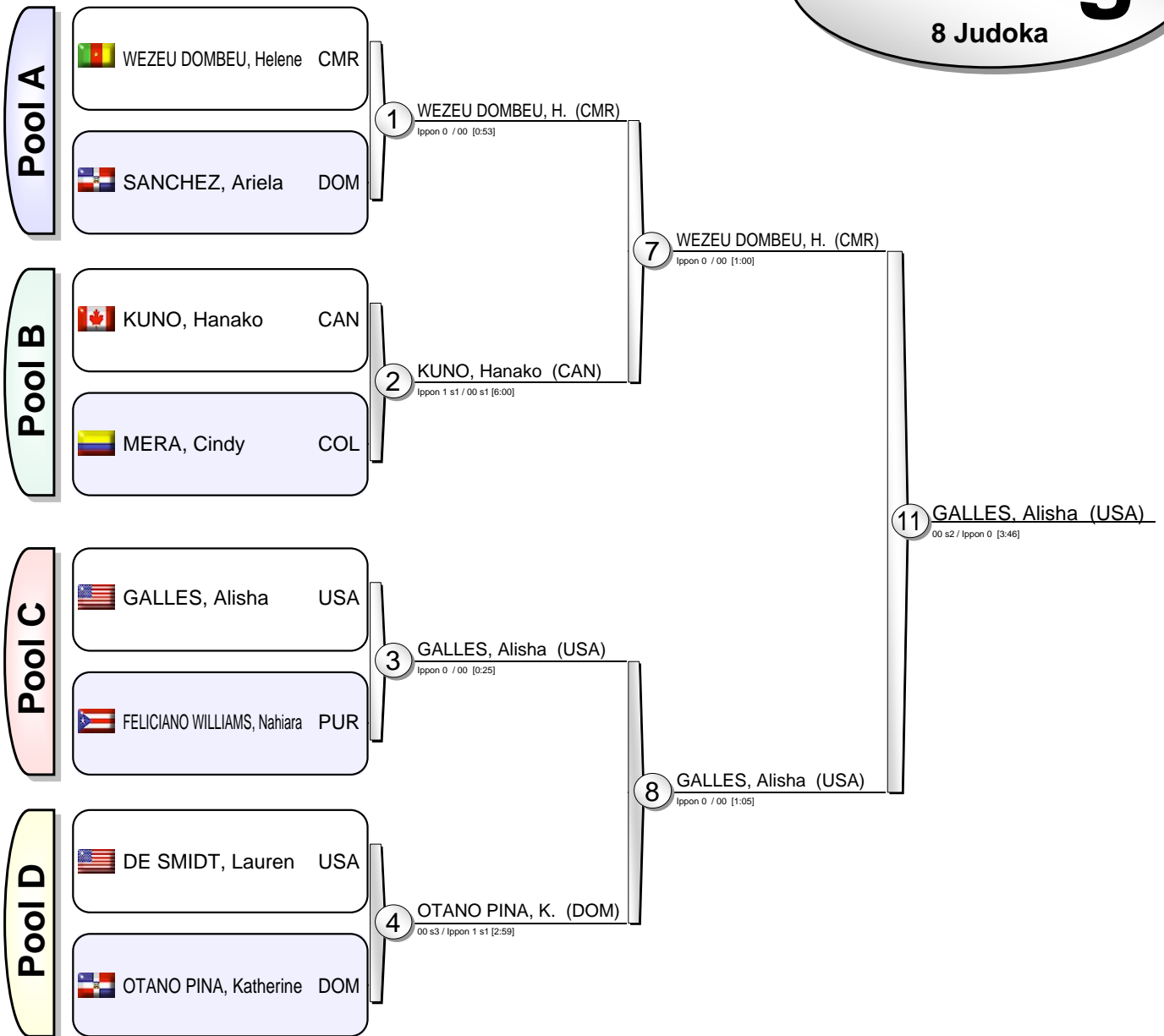

Results		
1.	GALLES, Alisha	USA
2.	WEZEU DOMBEU, Helene	CMR
3.	SANCHEZ, Ariela	DOM
3.	KUNO, Hanako	CAN
5.	OTANO PINA, Katherine	DOM
5.	DE SMIDT, Lauren	USA
7.	MERA, Cindy	COL
7.	FELICIANO WILLIAMS, Nahara	PUR



Pan-American Open Santo Domingo 2018

(DOM Santo Domingo, 1-2 September 2018)

-70 kg

8 Judoka

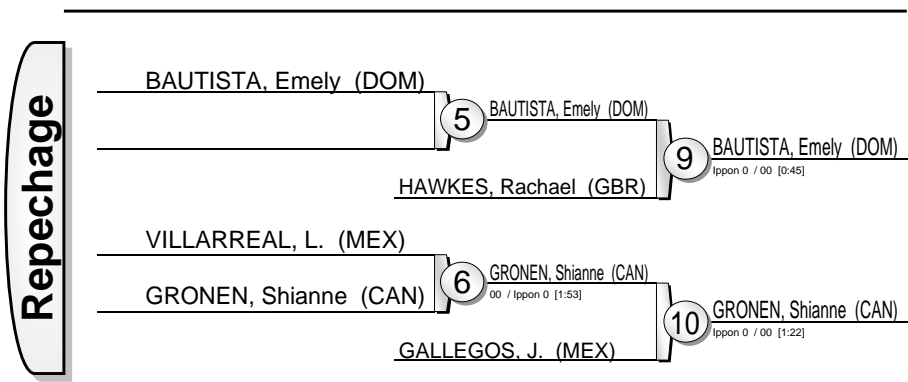
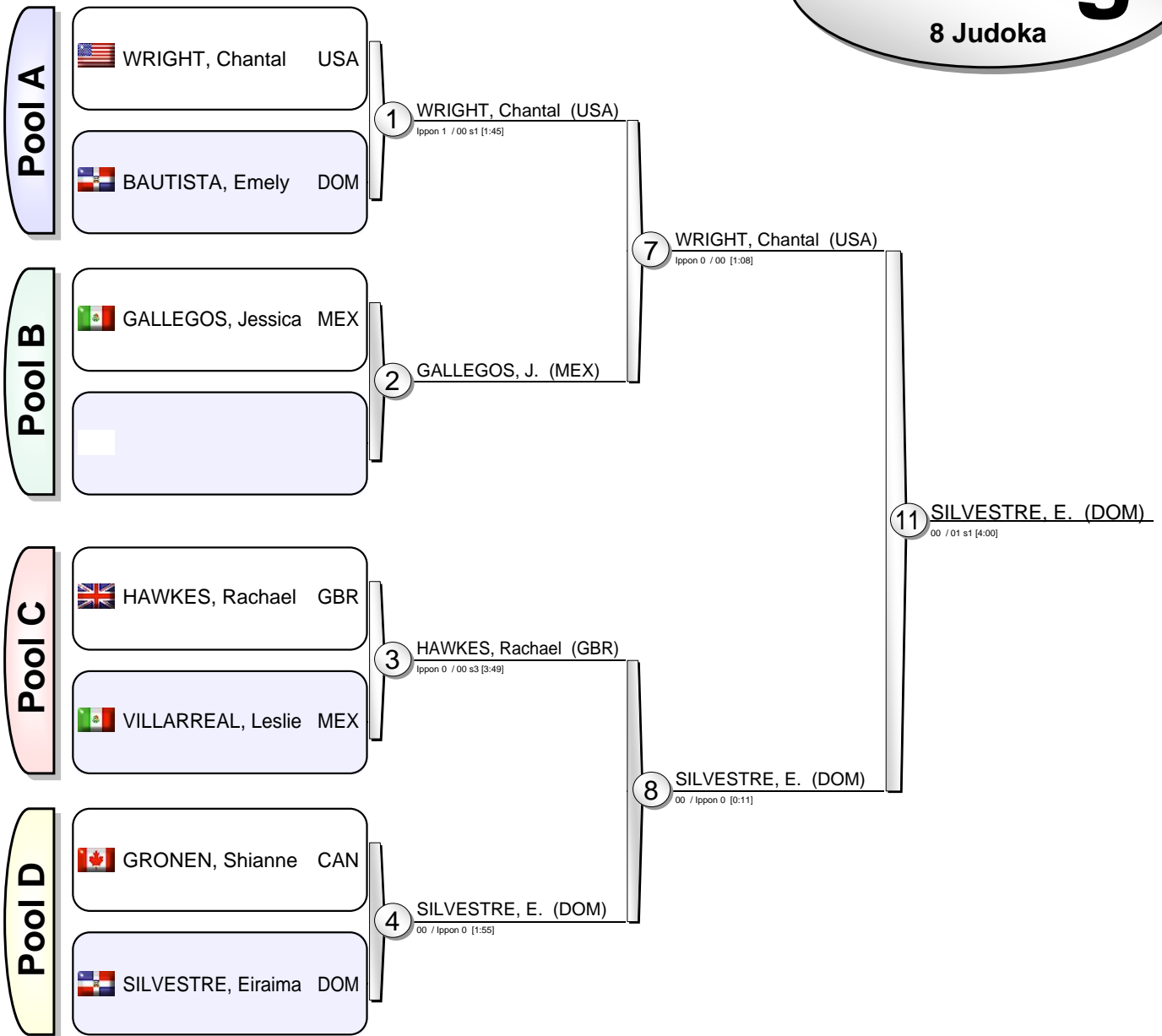

Results		
1.	SILVESTRE, Eiraima	DOM
2.	WRIGHT, Chantal	USA
3.	BAUTISTA, Emely	DOM
3.	GRONEN, Shianne	CAN
5.	HAWKES, Rachael	GBR
5.	GALLEGOS, Jessica	MEX
7.		
7.	VILLARREAL, Leslie	MEX



Pan-American Open Santo Domingo 2018

(DOM Santo Domingo, 1-2 September 2018)

-78 kg

5 Judoka

			1	3	5	Wins	Scores
1	LEON, Karen	VEN		+	+	2	(20)
3	STOUT, Nicole	USA	-		+	1	(10)
5	RAMIREZ, Omaria	DOM	-	-		0	(0)

			2	4	Wins	Scores
2	PAPADAKIS, Nefeli	USA		-	0	(0)
4	MAZOUZ, Sarah Myriam	GAB	+		1	(10)

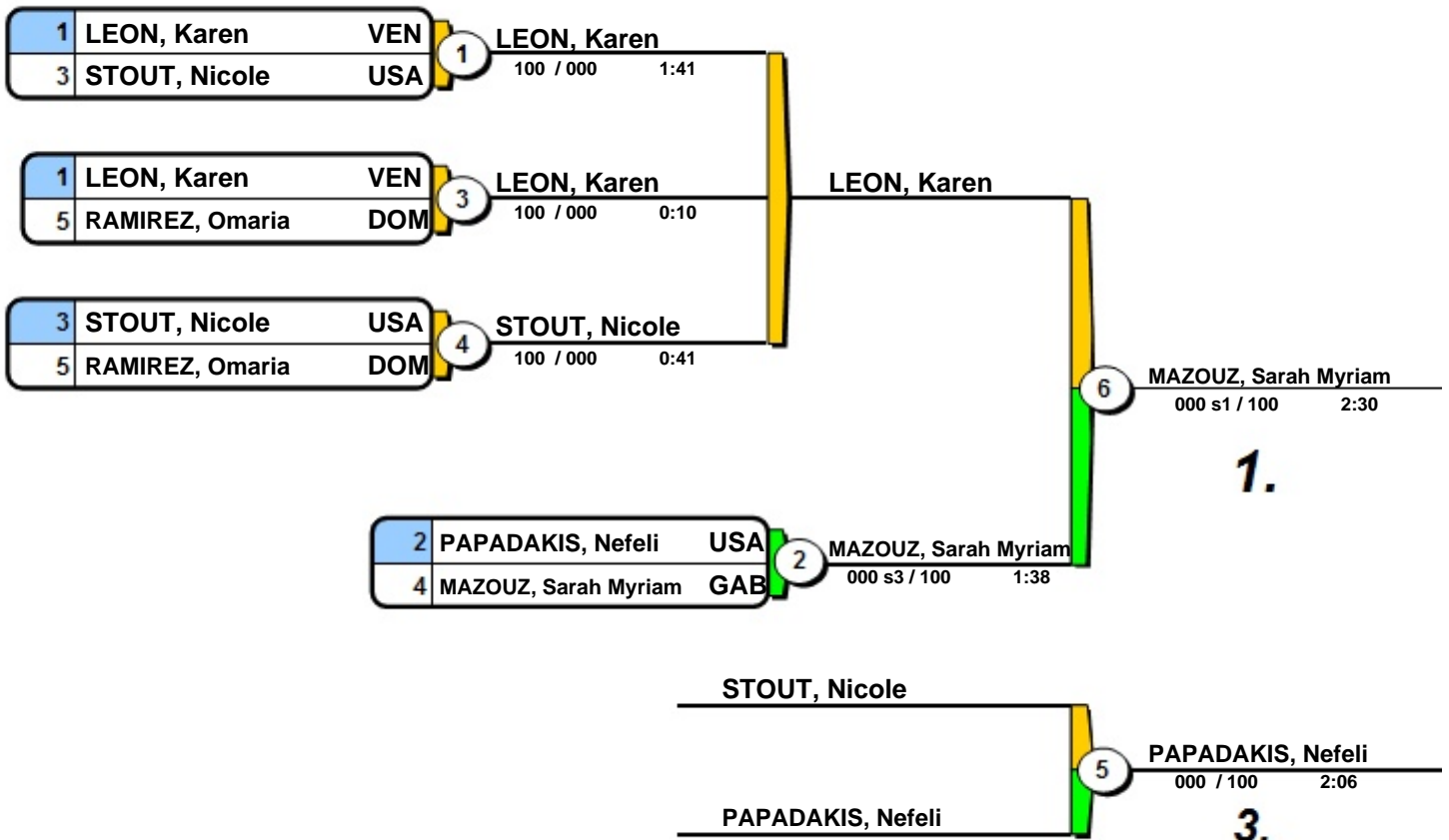

- 1. MAZOUZ, Sarah Myriam GAB
- 2. LEON, Karen VEN
- 3. PAPADAKIS, Nefeli USA



Pan-American Open Santo Domingo 2018

(DOM Santo Domingo, 1-2 September 2018)

+78 kg

8 Judoka

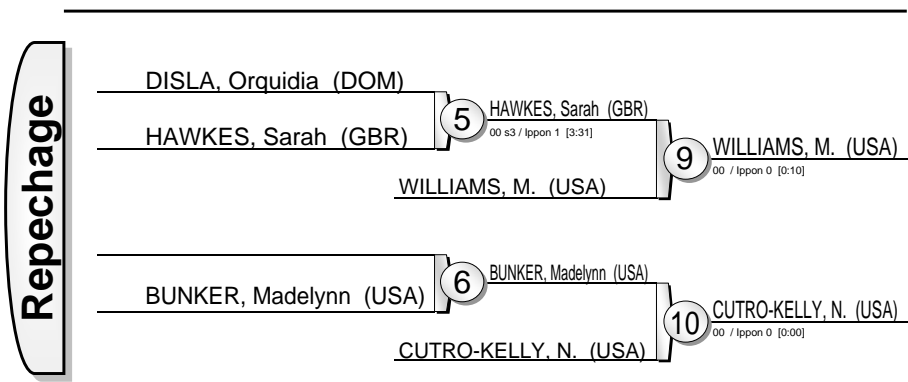
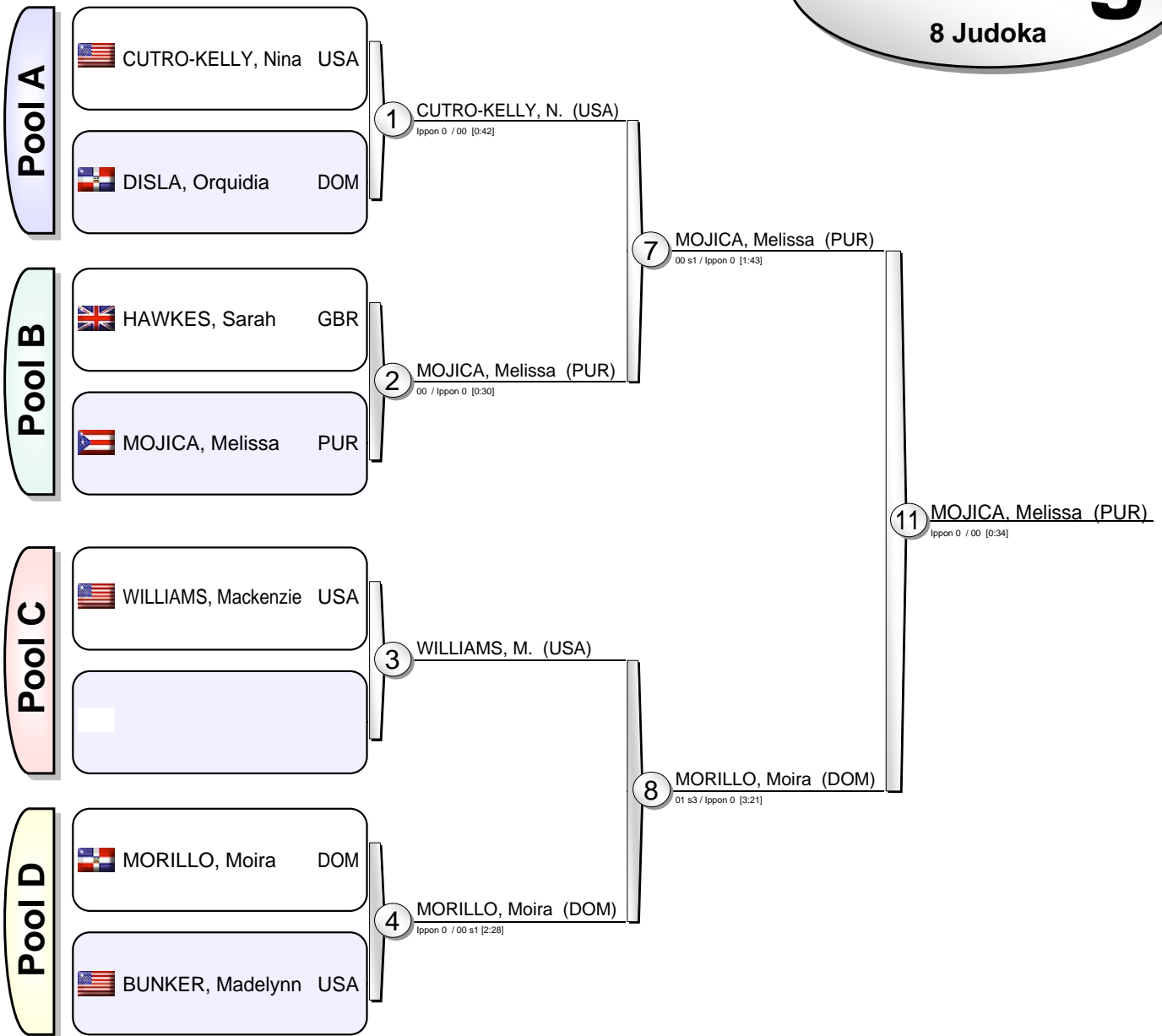

Results		
1.	MOJICA, Melissa	PUR
2.	MORILLO, Moira	DOM
3.	WILLIAMS, Mackenzie	USA
3.	CUTRO-KELLY, Nina	USA
5.	HAWKES, Sarah	GBR
5.	BUNKER, Madelynn	USA
7.	DISLA, Orquidia	DOM
7.		