



Pan-American Open Lima 2019

(PER Lima, 9-10 March 2019)

-60 kg

15 Judoka

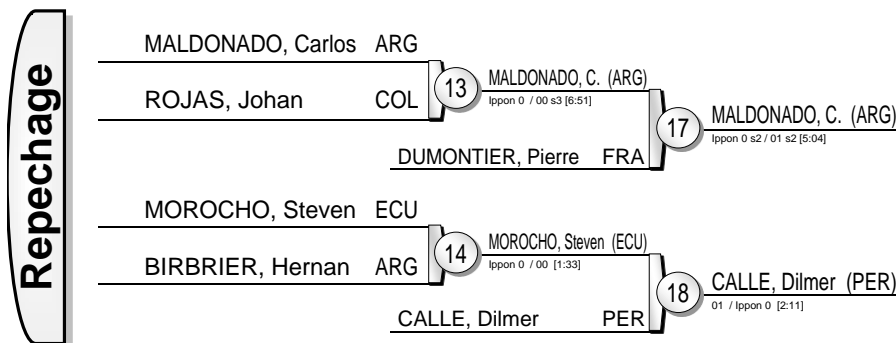

Results		
1.	FUTTINICO, John	COL
2.	POKLITAR, Gueorgui	CAN
3.	MALDONADO, Carlos	ARG
3.	CALLE, Dilmer	PER
5.	DUMONTIER, Pierre	FRA
5.	MOROCHO, Steven	ECU
7.	ROJAS, Johan	COL
7.	BIRBRIER, Hernan	ARG





Pan-American Open Lima 2019

(PER Lima, 9-10 March 2019)

-66 kg

16 Judoka

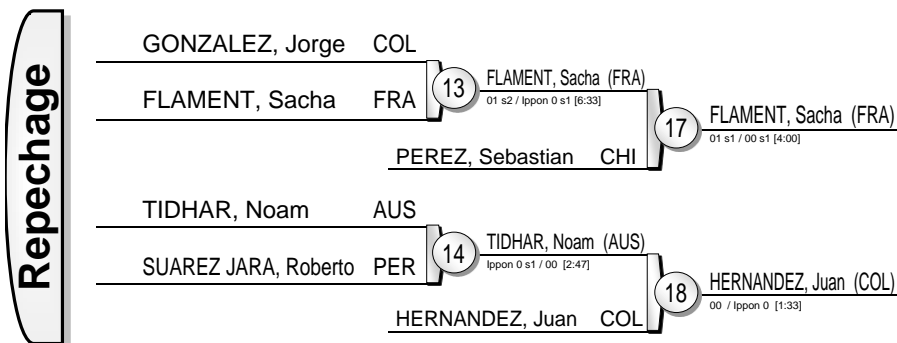

Results		
1.	POSTIGOS, Juan	PER
2.	TAMASHIRO, Minoru	ARG
3.	FLAMENT, Sacha	FRA
3.	HERNANDEZ, Juan	COL
5.	PEREZ, Sebastian	CHI
5.	TIDHAR, Noam	AUS
7.	GONZALEZ, Jorge	COL
7.	SUAREZ JARA, Roberto	PER





Pan-American Open Lima 2019

(PER Lima, 9-10 March 2019)

-73 kg

12 Judoka



Results		
1.	OTMANE, Luca	FRA
2.	KNOESTER, Calvin	AUS
3.	NAVARRO, Leider	COL
3.	WONG, Alonso	PER
5.	METELLUS, Philippe Abel	HAI
5.	SALEM, Salama	USA
7.	BARTHE CHIRRINOS, Aldair	PER
7.	JOSE, Diaz	PER





Pan-American Open Lima 2019

(PER Lima, 9-10 March 2019)

-81 kg

15 Judoka



Results		
1.	ROSA MOYA, Alexis	ESP
2.	ANGELES SOTELO, Luis	PER
3.	HERRERO, Igor	ESP
3.	MORALES, Tomas	ARG
5.	VEGA, Luis	ARG
5.	CHOQUE, Dimitri	FRA
7.	JACOBSON, Alex	USA
7.	FLEMING, Eoin	IRL

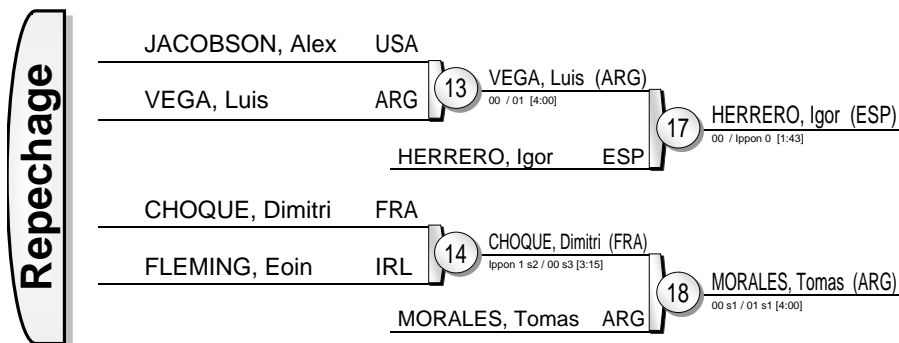



Pan-American Open Lima 2019

(PER Lima, 9-10 March 2019)

-90 kg

10 Judoka

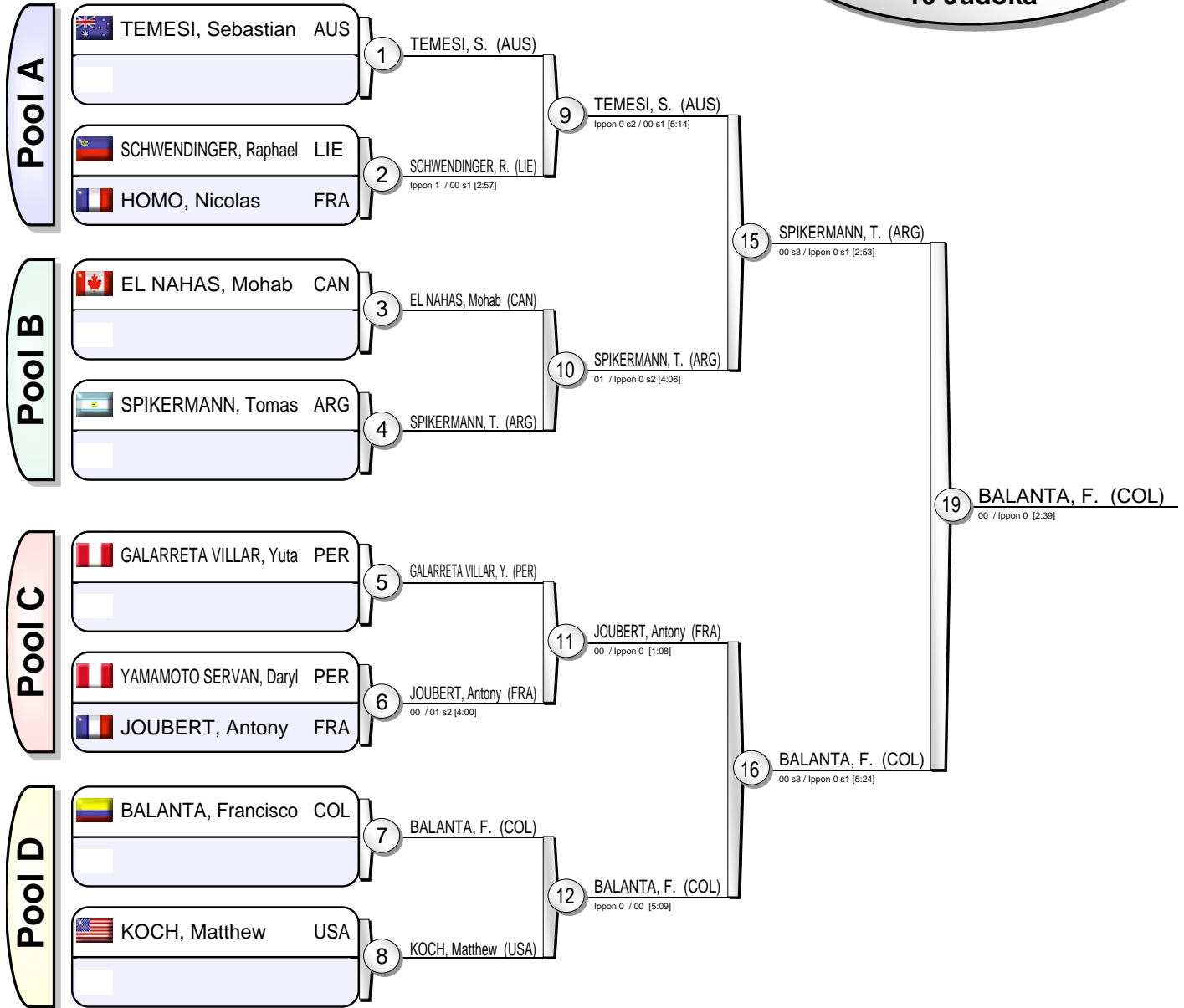

Results		
1.	BALANTA, Francisco	COL
2.	SPIKERMANN, Tomas	ARG
3.	JOUBERT, Antony	FRA
3.	GALARRETA VILLAR, Yuta	PER
5.	SCHWENDINGER, Raphael	LIE
5.	TEMESI, Sebastian	AUS
7.	EL NAHAS, Mohab	CAN
7.	KOCH, Matthew	USA





Pan-American Open Lima 2019

(PER Lima, 9-10 March 2019)

-100 kg

9 Judoka



Results		
1.	BRICENO, Thomas	CHI
2.	ARROYO OSORNO, Jose Luis	PER
3.	KOSTER, Jason	NZL
3.	GARZON, Carlos	COL
5.	ANGULO, Junior	ECU
5.	APRAHAMIAN, Pablo	URU
7.	BENTO, Casimiro	ANG
7.	GUERALT, Michael	CAN





Pan-American Open Lima 2019

(PER Lima, 9-10 March 2019)

+100 kg

4 Judoka

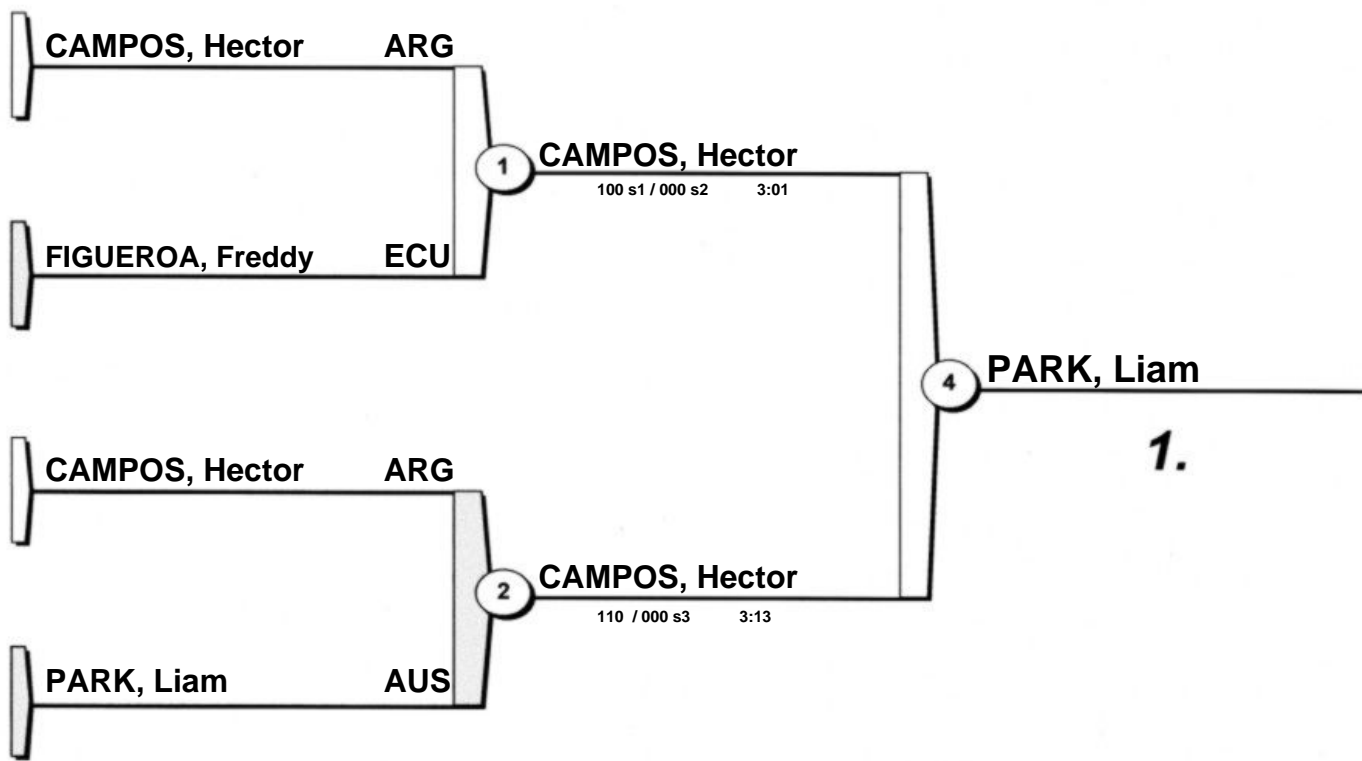

FIGUEROA, Freddy

PARK, Liam

010 / 100 s1 2:39

PARK, Liam

- | | |
|-------------------|-----|
| 1. PARK, Liam | AUS |
| 2. CAMPOS, Hector | ARG |
| 3. PARK, Liam | AUS |



Pan-American Open Lima 2019

(PER Lima, 9-10 March 2019)

-48 kg

6 Judoka

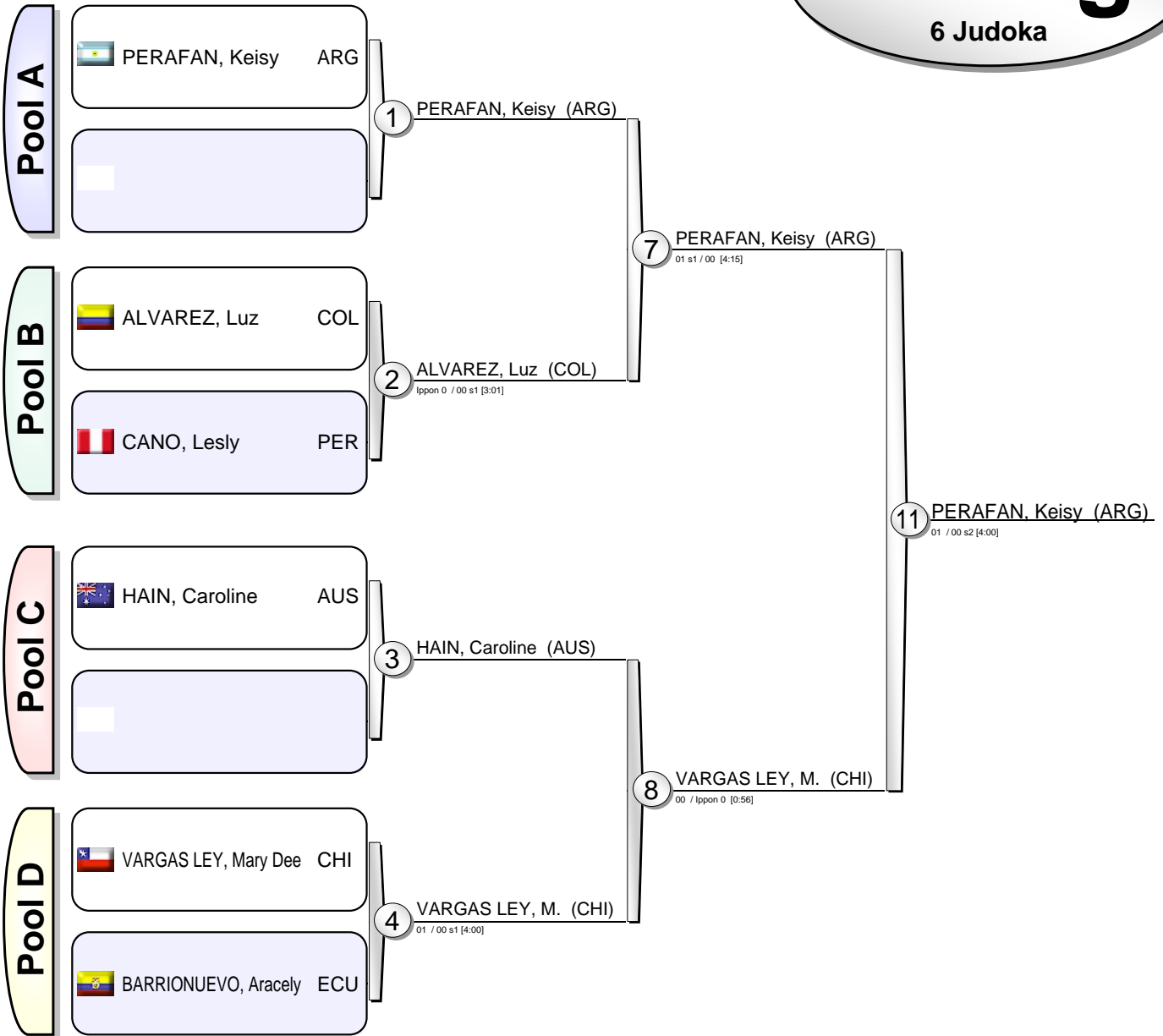

Results

- PERAFAN, Keisy ARG
- VARGAS LEY, Mary Dee CHI
- CANO, Lesly PER
- ALVAREZ, Luz COL
- HAIN, Caroline AUS
- BARRIONUEVO, Aracely ECU
-
-





Pan-American Open Lima 2019

(PER Lima, 9-10 March 2019)

-52 kg

7 Judoka

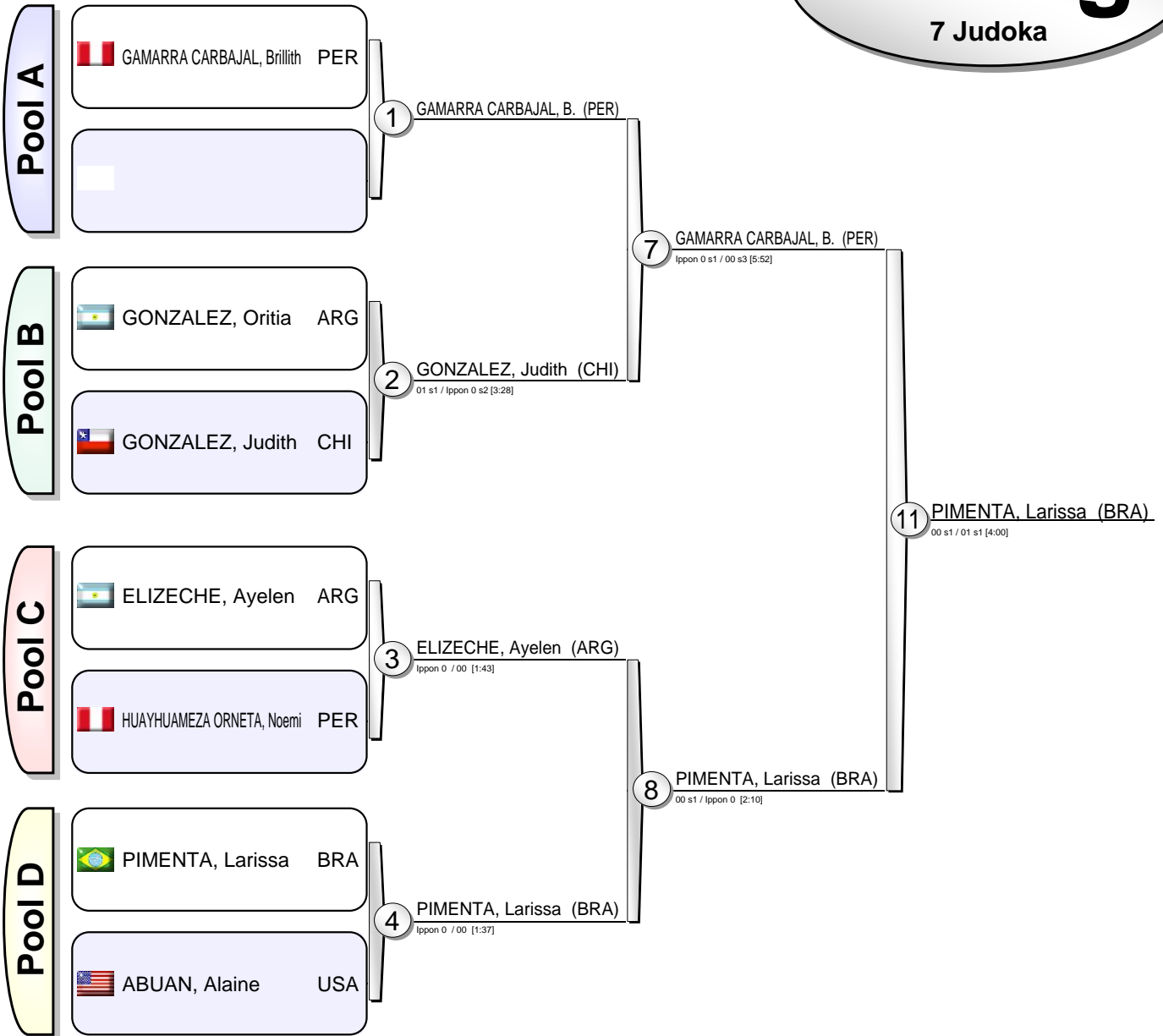

Results

1. PIMENTA, Larissa BRA
2. GAMARRA CARBAJAL, Brillith PER
3. ELIZECHE, Ayelen ARG
3. ABUAN, Alaine USA
5. GONZALEZ, Oritia ARG
5. GONZALEZ, Judith CHI
- 7.
7. HUAYHUAMEZA ORNETA, Noemi PER





Pan-American Open Lima 2019

(PER Lima, 9-10 March 2019)

-57 kg

10 Judoka



Results		
1.	PERISIC, Marica	SRB
2.	FULGENTES, Amelia	USA
3.	BISHOP, Justine	NZL
3.	EBRAHIM, Shadi	USA
5.	FLORES, Marian	PER
5.	RAHMING, Cynthia	BAH
7.		
7.	ARANGO MIRANDA, Kiara	PER





Pan-American Open Lima 2019

(PER Lima, 9-10 March 2019)

-63 kg

8 Judoka

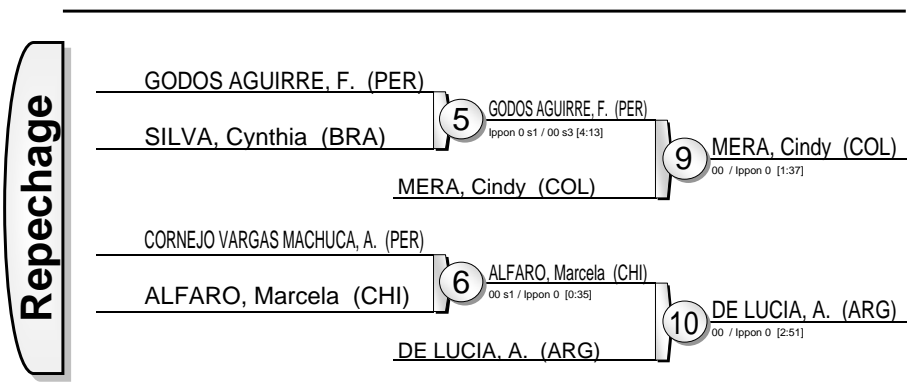
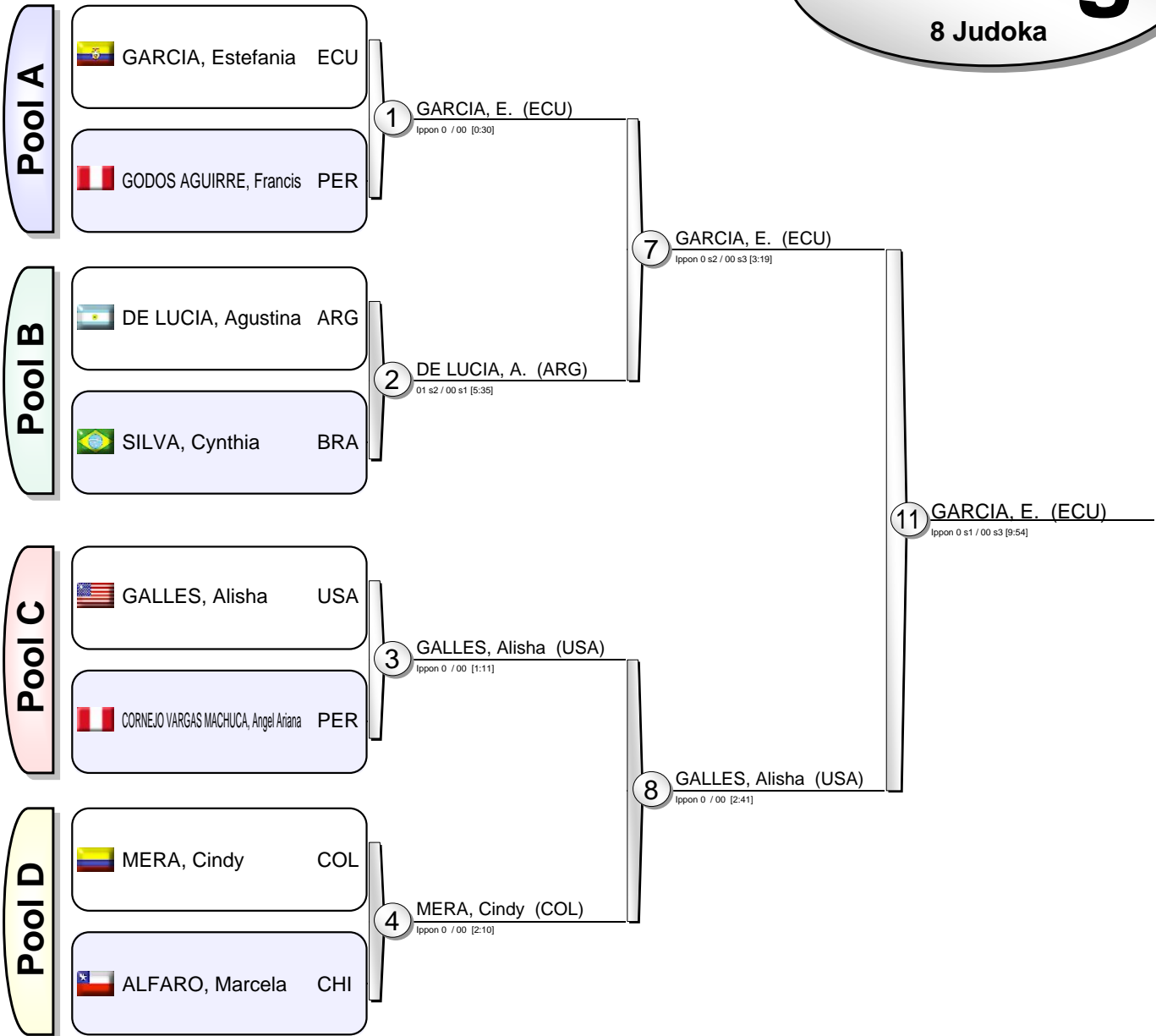

Results		
1.	GARCIA, Estefania	ECU
2.	GALLES, Alisha	USA
3.	MERA, Cindy	COL
3.	DE LUCIA, Agustina	ARG
5.	GODOS AGUIRRE, Francis	PER
5.	ALFARO, Marcela	CHI
7.	SILVA, Cynthia	BRA
7.	CORNEJO VARGAS MACHUCA, Angel Ariana	PER





Pan-American Open Lima 2019

(PER Lima, 9-10 March 2019)

-70 kg

3 Judoka

			1	2	3			
1	HOFMAN, Urszula	POL		-	+	10	1 (10)	
2	SANTANA, Ellen	BRA	+		+	10	2 (20)	
3	MORALES FALCONI, Xsara	PER	-	-			0 (0)	

1	HOFMAN, Urszula	POL	1	SANTANA, Ellen		BRA
2	SANTANA, Ellen	BRA		000 s1 / 100 s1	2:43	

1	HOFMAN, Urszula	POL	2	HOFMAN, Urszula		POL
3	MORALES FALCONI, Xsara	PER		100 / 000 s2	1:45	

2	SANTANA, Ellen	BRA	3	SANTANA, Ellen		BRA
3	MORALES FALCONI, Xsara	PER		100 / 000	2:01	

1. SANTANA, Ellen BRA
2. HOFMAN, Urszula POL



Pan-American Open Lima 2019

(PER Lima, 9-10 March 2019)

-78 kg

5 Judoka

	1	3	5	Wins	Scores
1 CHALA, Vanessa ECU		+	+	2	(20)
3 MAZOUZ, Sarah Myriam GAB	-		-	0	(0)
5 FIGUEROA AQUINO, Camila PER	-	+		1	(10)

	2	4	Wins	Scores
2 WALLIS, Melanie AUS		-	0	(0)
4 CANTERO, Lucia ARG	+		1	(7)

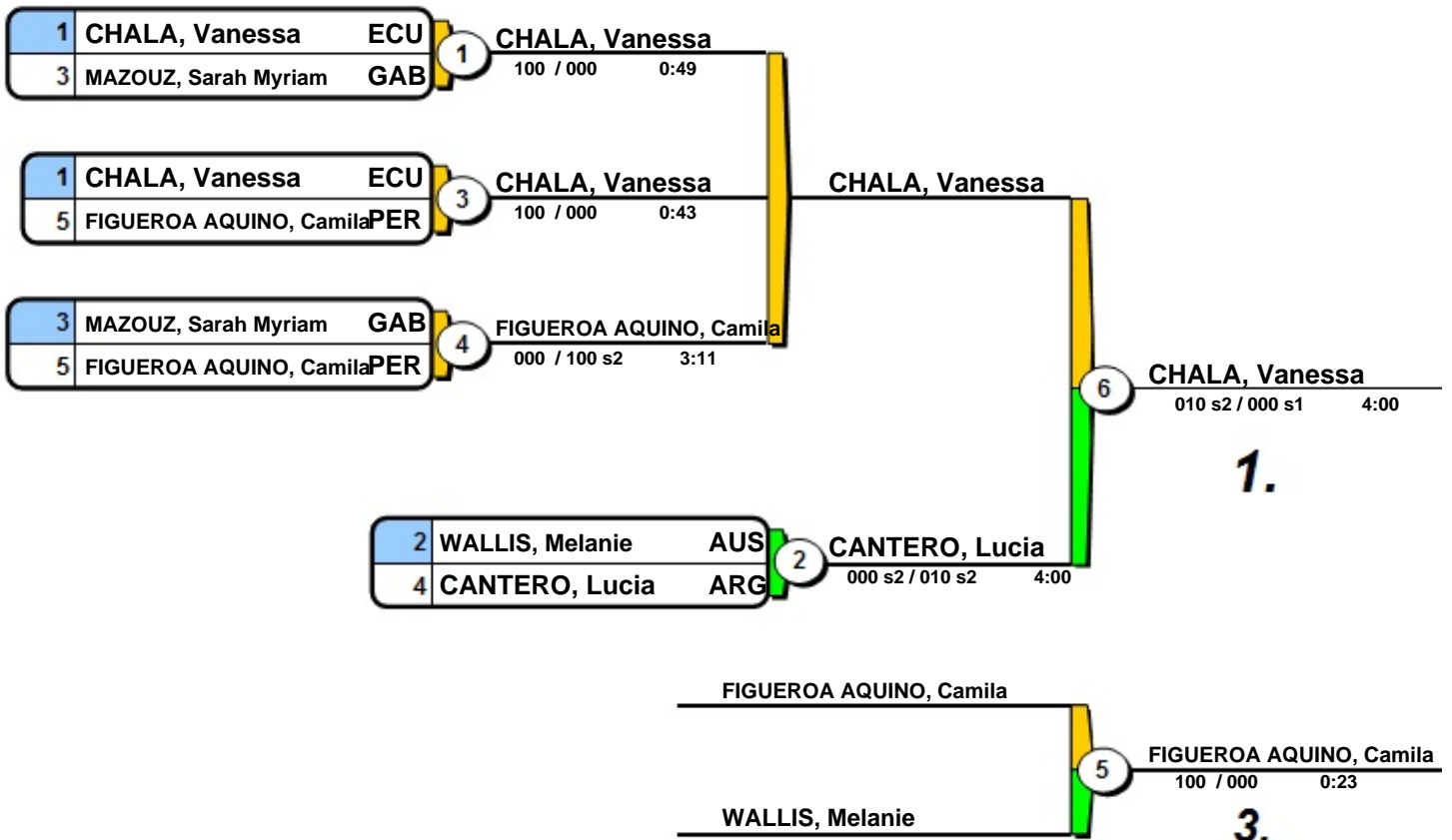

- 1. CHALA, Vanessa ECU
- 2. CANTERO, Lucia ARG
- 3. FIGUEROA AQUINO, Camila PER



Pan-American Open Lima 2019

(PER Lima, 9-10 March 2019)

+78 kg

3 Judoka

			1	2	3		
1	FUENTEALBA, Josefina	CHI		+	+	2 (20)	
2	WILLIAMS, Mackenzie	USA	-		+	1 (10)	
3	BREDESTON, Amanda	ARG	-	-		0 (0)	

1	FUENTEALBA, Josefina	CHI	1	FUENTEALBA, Josefina	CHI
2	WILLIAMS, Mackenzie	USA		100 / 010	0:35

1	FUENTEALBA, Josefina	CHI	2	FUENTEALBA, Josefina	CHI
3	BREDESTON, Amanda	ARG		100 s1 / 000	3:35

2	WILLIAMS, Mackenzie	USA	3	WILLIAMS, Mackenzie	USA
3	BREDESTON, Amanda	ARG		100 / 000 s1	2:20

1. FUENTEALBA, Josefina CHI
2. WILLIAMS, Mackenzie USA