



# Pan-American Open Santiago de Chile 2014

(CHI Santiago de Chile, 26-27 July 2014)

# -60 kg

14 Judoka

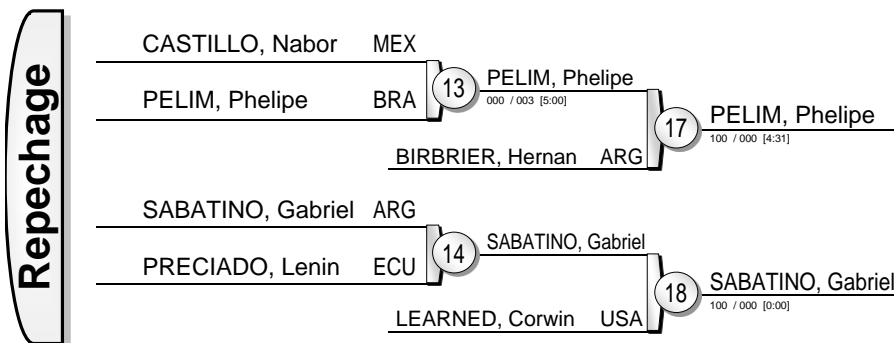

Results		
1.	SANTOS, Diego	BRA
2.	KUNIHIRO, Aaron	USA
3.	PELIM, Phelipe	BRA
3.	SABATINO, Gabriel	ARG
5.	BIRBRIER, Hernan	ARG
5.	LEARNED, Corwin	USA
7.	CASTILLO, Nabor	MEX
7.	PRECIADO, Lenin	ECU





# Pan-American Open Santiago de Chile 2014

(CHI Santiago de Chile, 26-27 July 2014)

# -66 kg

19 Judoka

Pool A

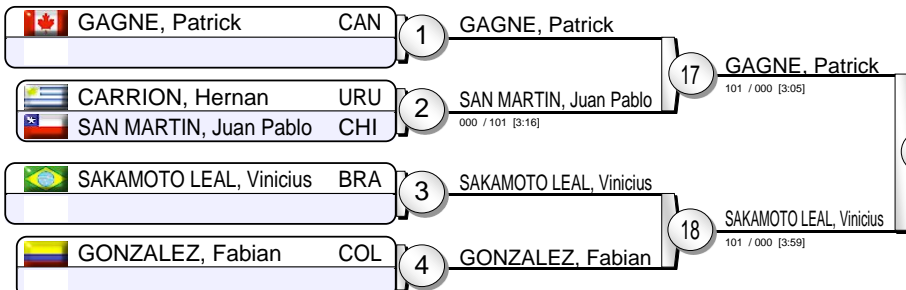

Pool B

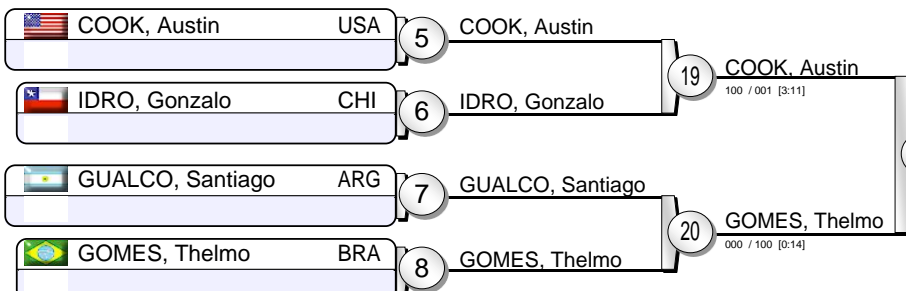

Pool C

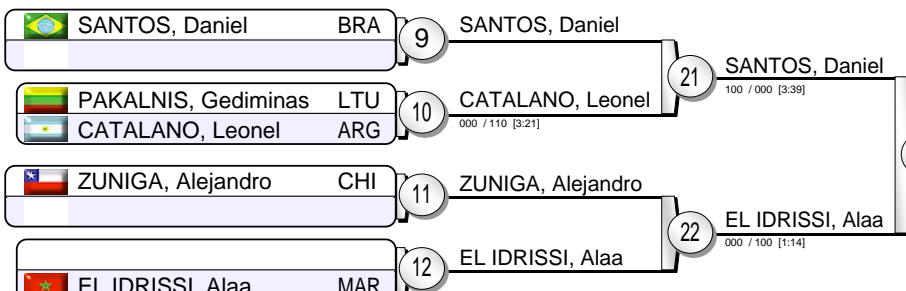

Pool D

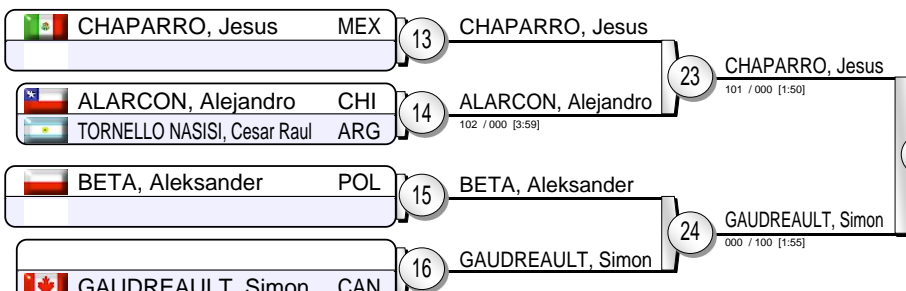

Repechage

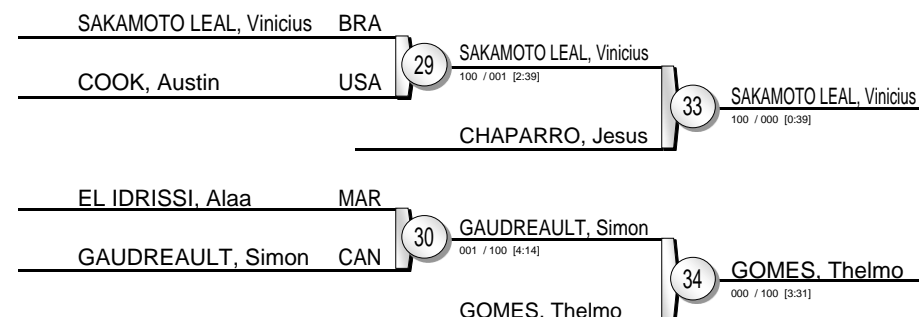

## Results

- GAGNE, Patrick CAN
- SANTOS, Daniel BRA
- SAKAMOTO LEAL, Vinicius BRA
- GOMES, Thelmo BRA
- CHAPARRO, Jesus MEX
- GAUDREULT, Simon CAN
- COOK, Austin USA
- EL IDRISSEI, Alaa MAR





# Pan-American Open Santiago de Chile 2014

(CHI Santiago de Chile, 26-27 July 2014)

# -73 kg

19 Judoka

Pool A

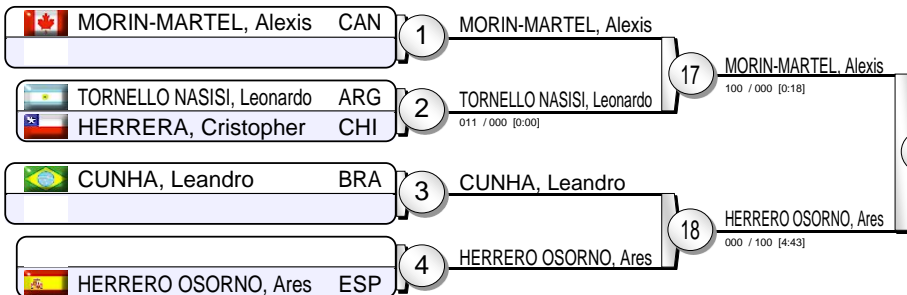

Pool B

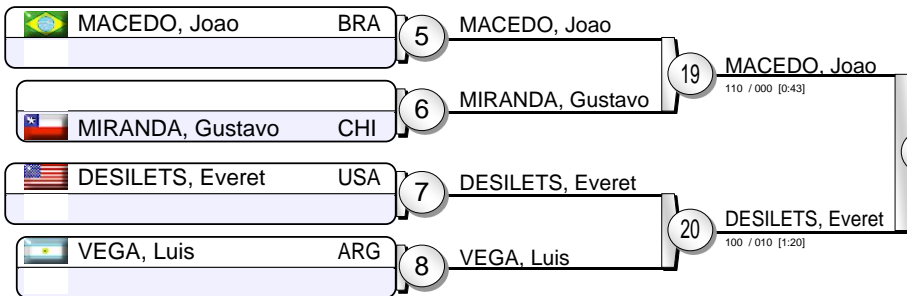

Pool C

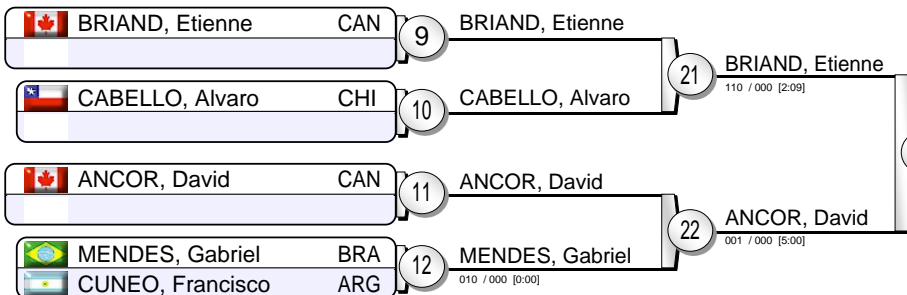

Pool D

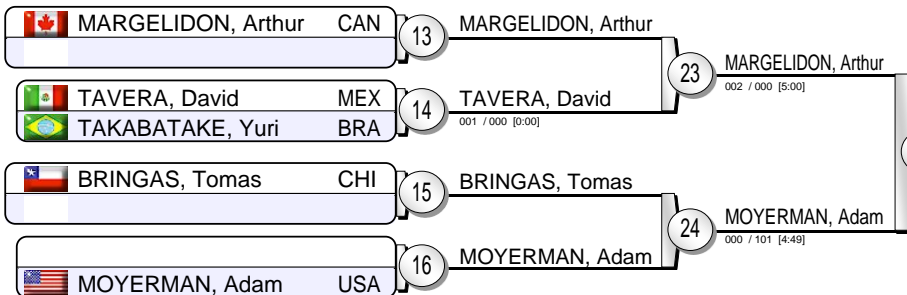

MACEDO, Joao 010 / 000 [5:00] 35

MARGELIDON, Arthur 32

Repechage

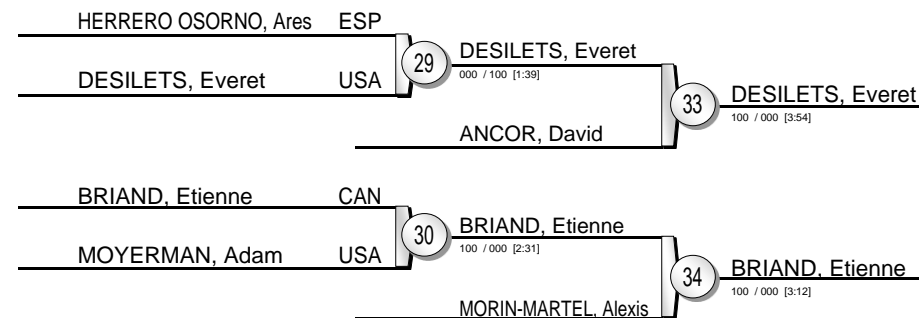

## Results

1. MACEDO, Joao BRA
2. MARGELIDON, Arthur CAN
3. DESILETS, Everet USA
3. BRIAND, Etienne CAN
5. ANCOR, David CAN
5. MORIN-MARTEL, Alexis CAN
7. HERRERO OSORNO, Ares ESP
7. MOYERMAN, Adam USA





# Pan-American Open Santiago de Chile 2014

(CHI Santiago de Chile, 26-27 July 2014)

# -81 kg

13 Judoka



Results		
1.	PANINI, Vinicius	BRA
2.	SALAZAR, Fernando	CHI
3.	BURT, Zachary	CAN
3.	CASTRO, Pedro	COL
5.	IDRO, Rodrigo	CHI
5.	CASTRO, Derian	COL
7.	AYALA, German	MEX
7.	APRAHAMIAN, Alain	URU





# Pan-American Open Santiago de Chile 2014

(CHI Santiago de Chile, 26-27 July 2014)

# -90 kg

15 Judoka



Results		
1.	CARDENAS, Isao	MEX
2.	BRICENO, Thomas	CHI
3.	RUIZ ZAJAC, David	ESP
3.	BROWN, Colton	USA
5.	SILVA, Henrique	BRA
5.	DUARTE, Alexis	ARG
7.	SHERAZADISHVILI, Nikoloz	ESP
7.	EDWARD, Robert	CAN

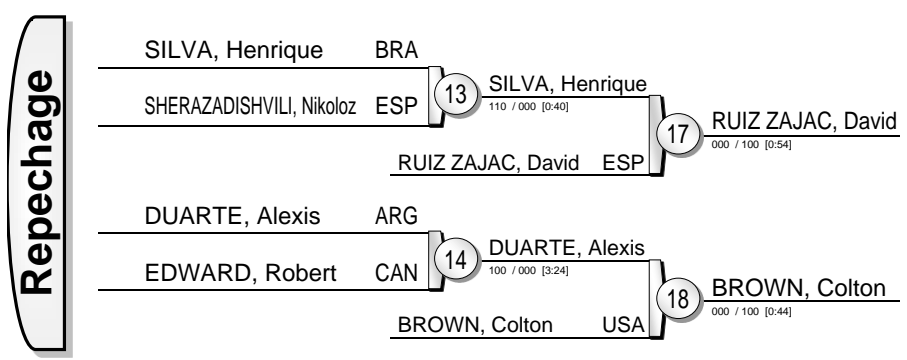



# Pan-American Open Santiago de Chile 2014

(CHI Santiago de Chile, 26-27 July 2014)

# -100 kg

11 Judoka



Results		
1.	DESCHENES, Marc	CAN
2.	GARCIA, Sergio	MEX
3.	TADEHARA, Ajax	USA
3.	ANTUNES, Horacio	BRA
5.	SCHLITTLER, Joao Gabriel	BRA
5.	BUENO, Manuel	URU
7.	BACCINO, Orlando	ARG
7.	PENA, Anthoni	VEN





# Pan-American Open Santiago de Chile 2014

(CHI Santiago de Chile, 26-27 July 2014)

# +100 kg

6 Judoka

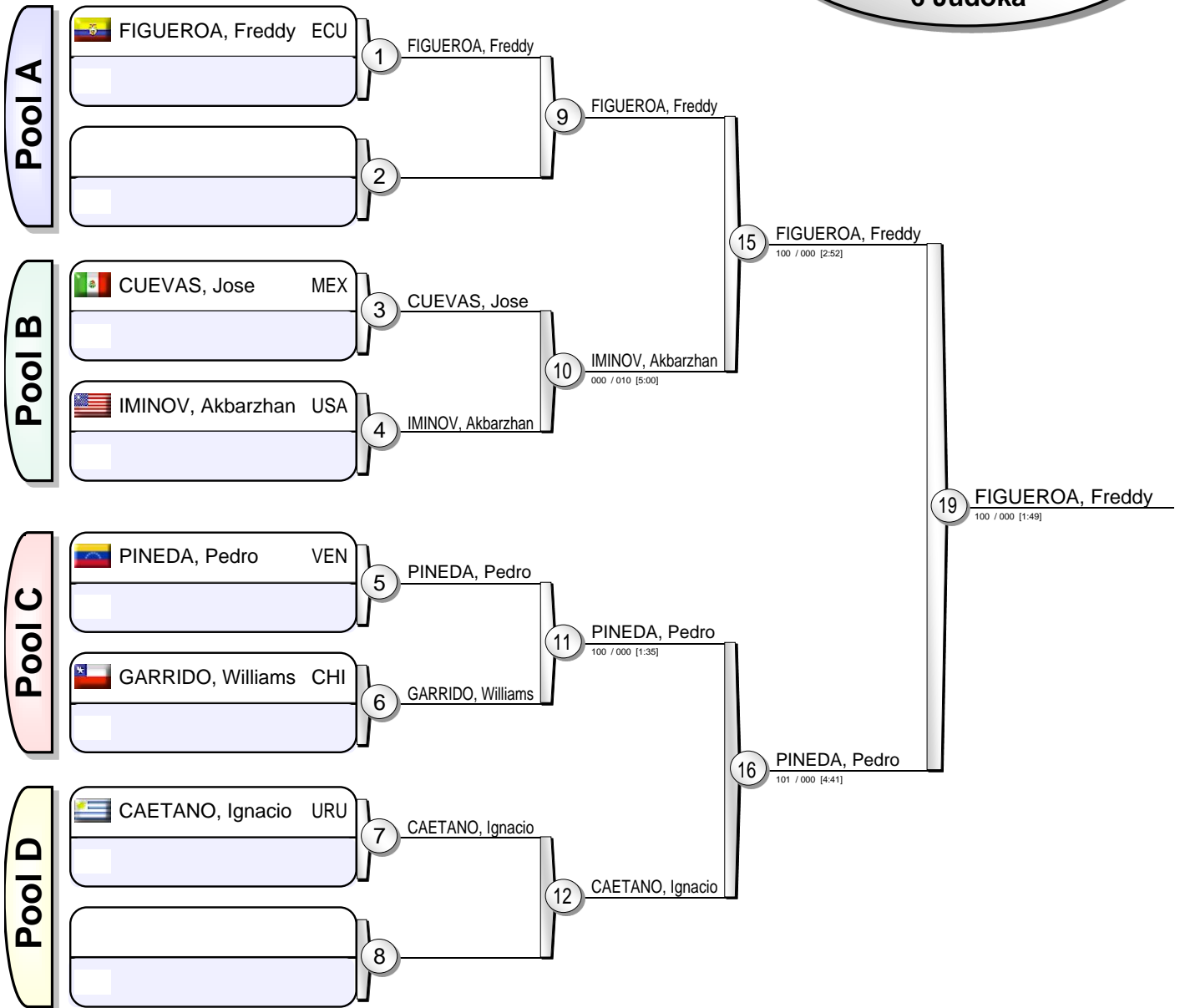

Results		
1.	FIGUEROA, Freddy	ECU
2.	PINEDA, Pedro	VEN
3.	CUEVAS, Jose	MEX
3.	IMINOV, Akbarzhan	USA
5.	CAETANO, Ignacio	URU
5.	GARRIDO, Williams	CHI
7.		
7.		

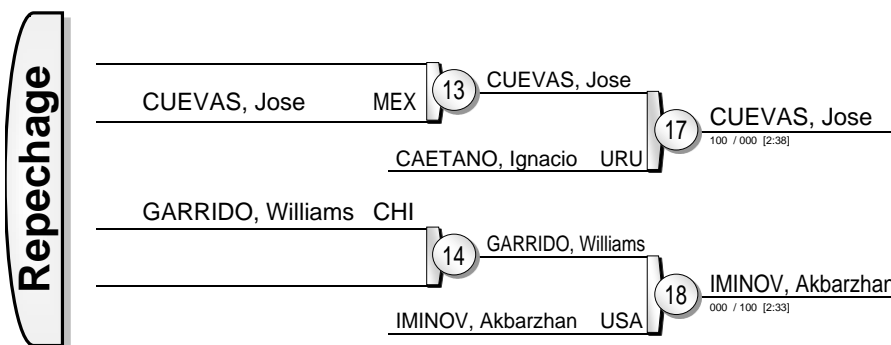



# Pan-American Open Santiago de Chile 2014

(CHI Santiago de Chile, 26-27 July 2014)

# -48 kg

11 Judoka

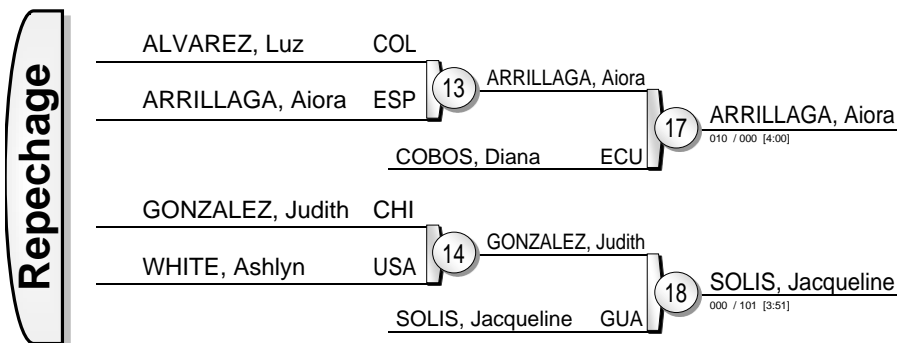

Results		
1.	CARRILLO, Edna	MEX
2.	FREITAS, Leandra	POR
3.	ARRILLAGA, Aiora	ESP
3.	SOLIS, Jacqueline	GUA
5.	COBOS, Diana	ECU
5.	GONZALEZ, Judith	CHI
7.	ALVAREZ, Luz	COL
7.	WHITE, Ashlyn	USA







# Pan-American Open Santiago de Chile 2014

(CHI Santiago de Chile, 26-27 July 2014)

# -52 kg

12 Judoka

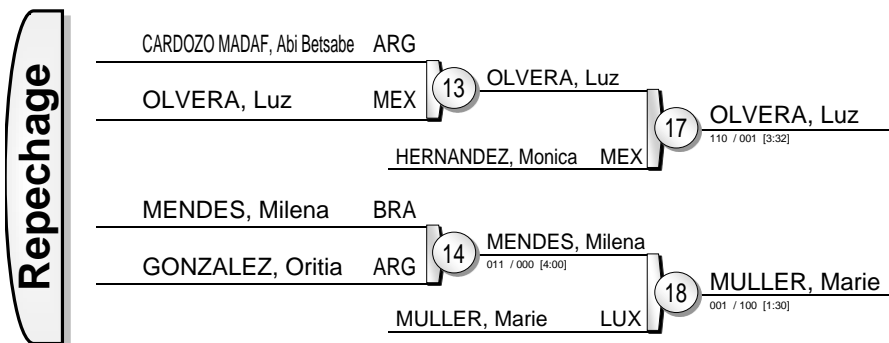

Results		
1.	HEYLEN, Ilse	BEL
2.	DELGADO, Angelica	USA
3.	OLVERA, Luz	MEX
3.	MULLER, Marie	LUX
5.	HERNANDEZ, Monica	MEX
5.	MENDES, Milena	BRA
7.	CARDOZO MADAF, Abi Betsabe	ARG
7.	GONZALEZ, Oritia	ARG





# Pan-American Open Santiago de Chile 2014

(CHI Santiago de Chile, 26-27 July 2014)

# -57 kg

8 Judoka

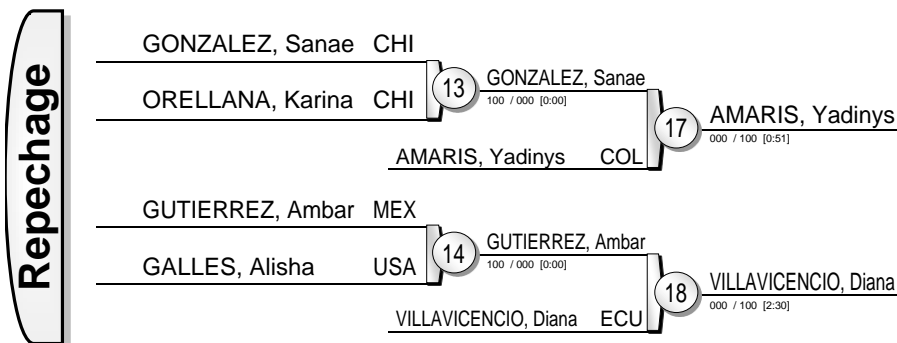

Results		
1.	TREMBLAY, Stefanie	CAN
2.	CARMICHAEL, Hana	USA
3.	AMARIS, Yadinys	COL
3.	VILLAVICENCIO, Diana	ECU
5.	GONZALEZ, Sanae	CHI
5.	GUTIERREZ, Ambar	MEX
7.	ORELLANA, Karina	CHI
7.	GALLES, Alisha	USA





# Pan-American Open Santiago de Chile 2014

(CHI Santiago de Chile, 26-27 July 2014)

# -63 kg

11 Judoka



- ### Results
- GARCIA, Estefania ECU
  - GUTIERREZ, Andrea MEX
  - BARBOSA DE LIMA, Dione BRA
  - AKIYAMA, Leilani USA
  - CACHOLA, Ana POR
  - MACHADO, Wisneybi VEN
  - BAEZ, Lauren USA
  - SALLES LOPEZ, Laura AND





# Pan-American Open Santiago de Chile 2014

(CHI Santiago de Chile, 26-27 July 2014)

## -70 kg

4 Judoka

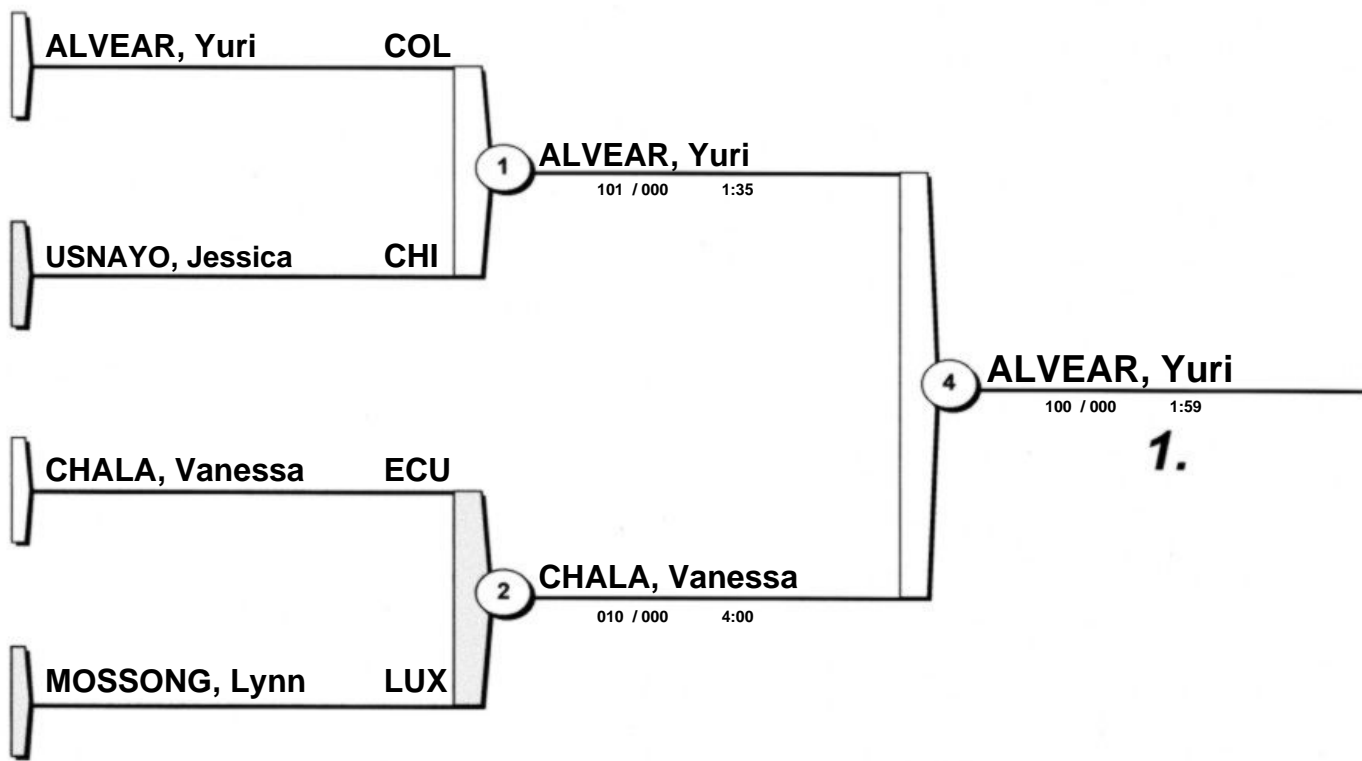

USNAYO, Jessica

MOSSONG, Lynn

000 / 101 2:16

MOSSONG, Lynn

- |                   |     |
|-------------------|-----|
| 1. ALVEAR, Yuri   | COL |
| 2. CHALA, Vanessa | ECU |
| 3. MOSSONG, Lynn  | LUX |



# Pan-American Open Santiago de Chile 2014

(CHI Santiago de Chile, 26-27 July 2014)

# -78 kg

8 Judoka

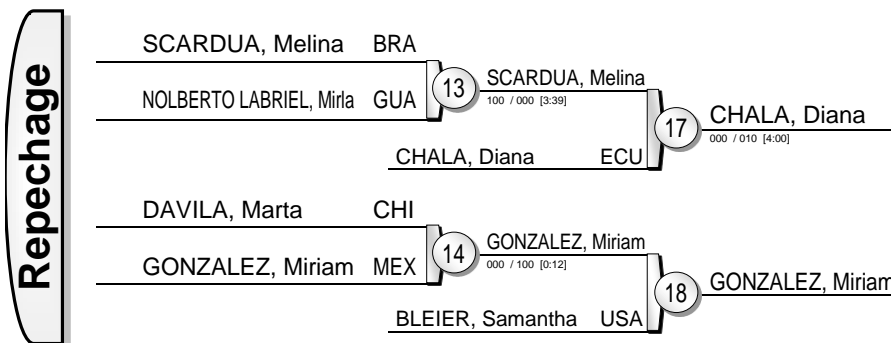
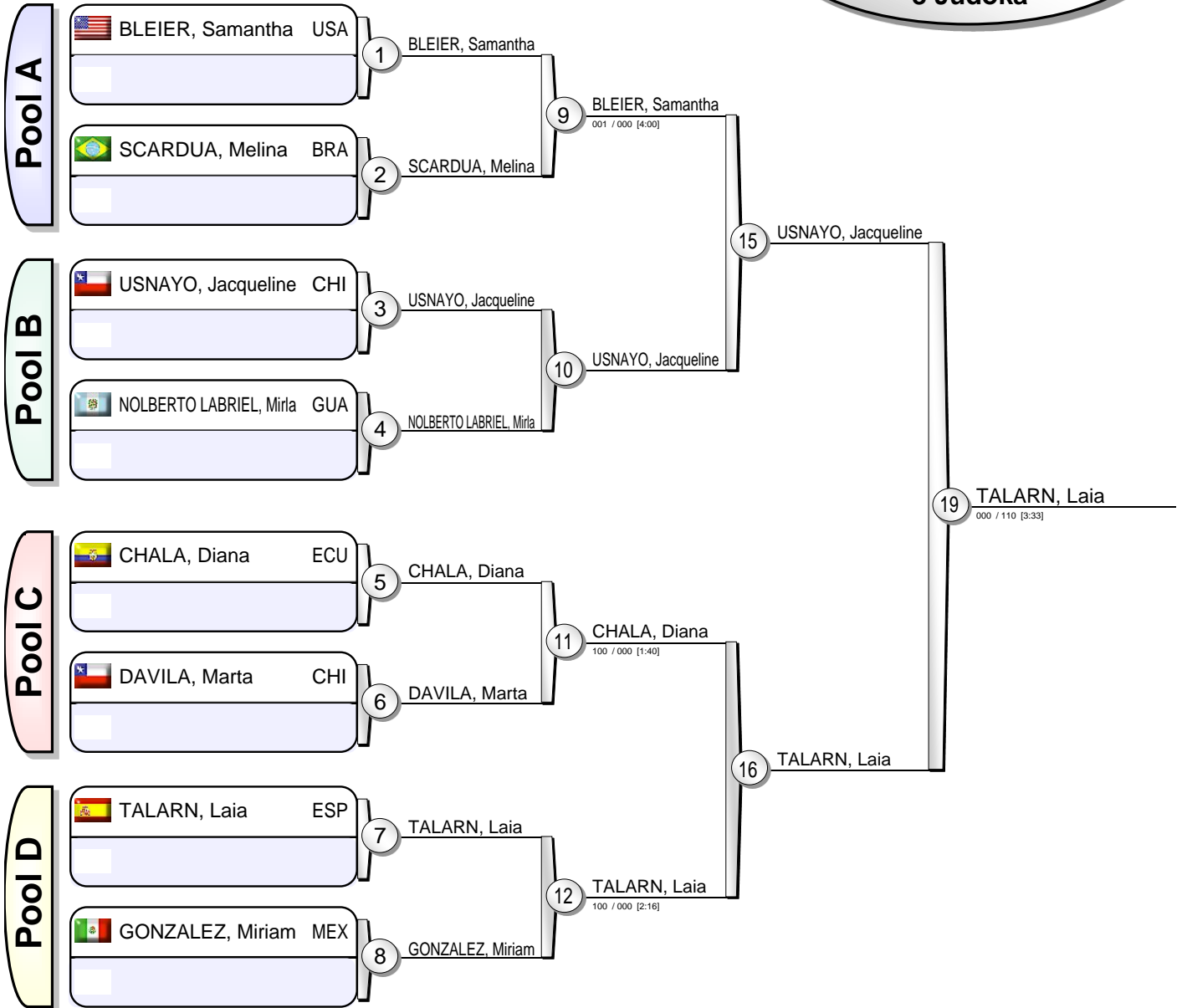

Results		
1.	TALARN, Laia	ESP
2.	USNAYO, Jacqueline	CHI
3.	CHALA, Diana	ECU
3.	GONZALEZ, Miriam	MEX
5.	SCARDUA, Melina	BRA
5.	BLEIER, Samantha	USA
7.	NOLBERTO LABRIEL, Mirla	GUA
7.	DAVILA, Marta	CHI





# Pan-American Open Santiago de Chile 2014

(CHI Santiago de Chile, 26-27 July 2014)

## +78 kg

4 Judoka

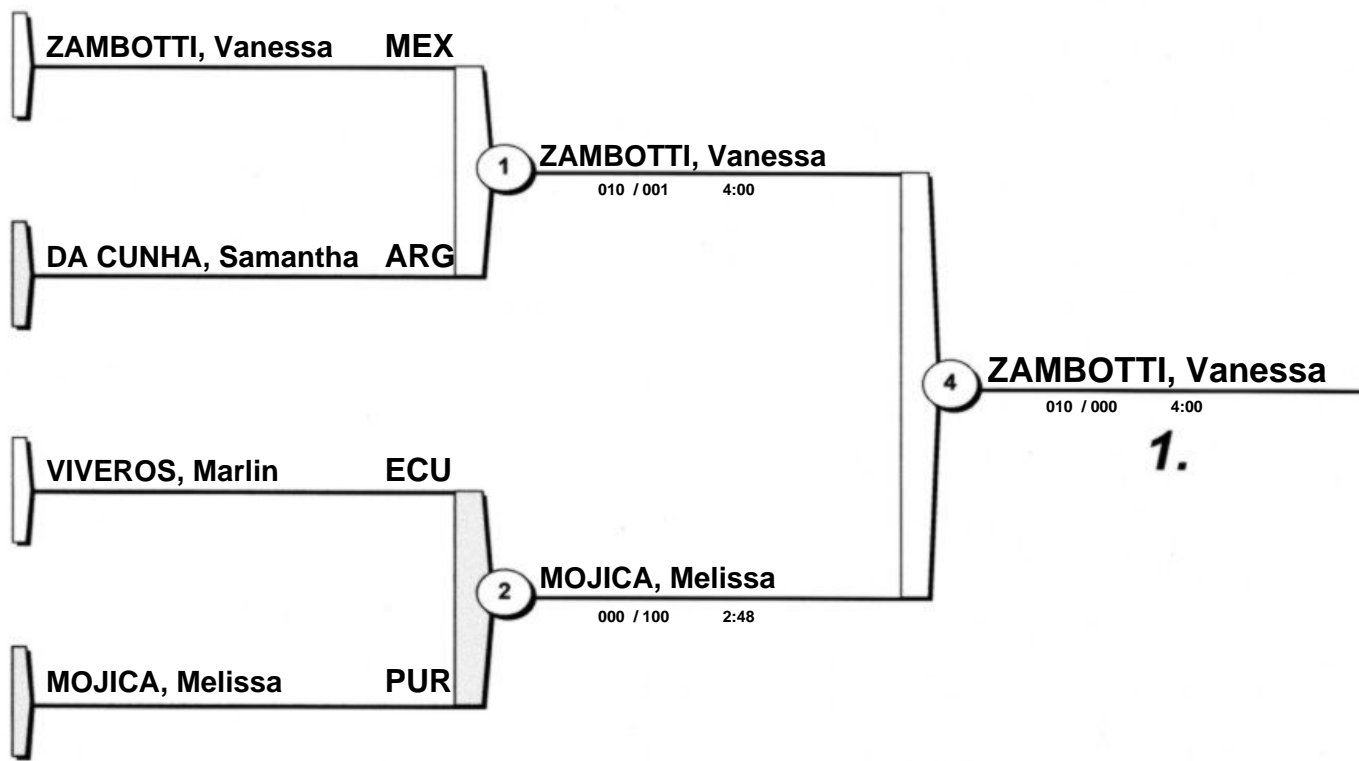

DA CUNHA, Samantha

VIVEROS, Marlin

000 / 101 3:30

VIVEROS, Marlin

1. ZAMBOTTI, Vanessa MEX
2. MOJICA, Melissa PUR
3. VIVEROS, Marlin ECU