

PARIS 2014

Catégorie

## DUO FEMININ PARIS

02/05/2014 21:30

	Nom - zone - club	1	3	1	2	4	2	nb Vict Points	CLASS.
		2	4	3	4	1	3		
1	BECIROVIC MIRNETA /BECIROVIC MIRNESA-AUT-Autriche	1 89,5	3 4	1 90,0	2 4	4 1	2 3	3 269,5	1
2	JUNGWIRTH SANDRA /ZELLER BIANCA-AUT-Autriche	0 77,0			0 84,5		0 83,5	0 245	4
3	ERNI ANTONIA /ERNI ALEXANDRA- -SUI-SUISSE		1 0	0 90,0			1 90,0	2 180	2
4	ITTENSOHN JASMIN /ITTENSOHN TANJA-GER-ALLEMAGNE		0 0		1 88,0	0 84,5		1 172,5	3

### CLASSEMENT

- 1- BECIROVIC MIRNETA /BECIROVIC MIRNESA-AUT-Autriche
- 2- ERNI ANTONIA /ERNI ALEXANDRA--SUI-SUISSE
- 3- ITTENSOHN JASMIN /ITTENSOHN TANJA-GER-ALLEMAGNE
- 4- JUNGWIRTH SANDRA /ZELLER BIANCA-AUT-Autriche

DUO MASCULIN PAR

02/05/2014 21:15

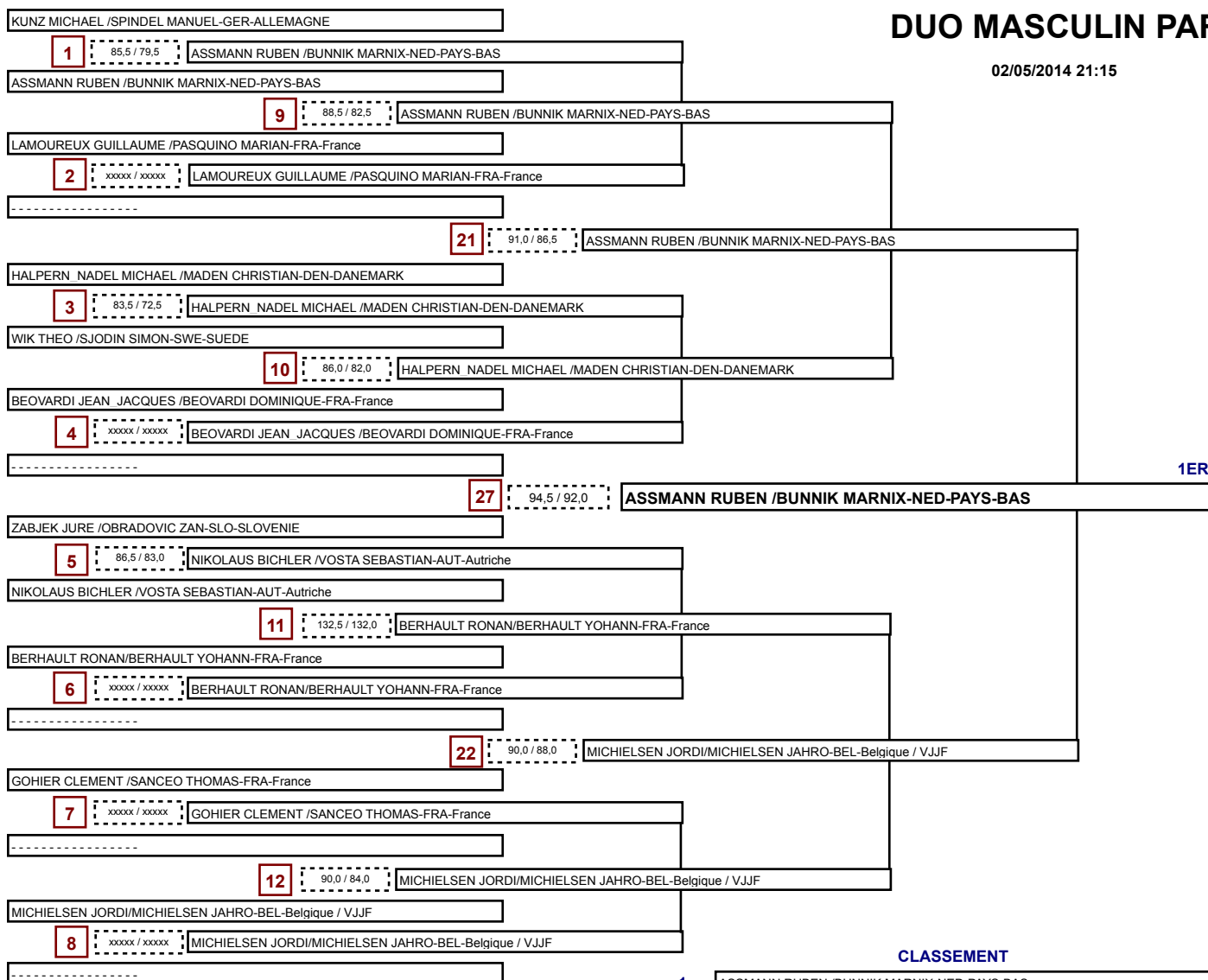

nb= 11 - combattants - repêchage intégral

CLASSEMENT

- 1- ASSMANN RUBEN / BUNNIK MARNIX-NED-PAYS-BAS
- 2- MICHELSEN JORDI / MICHELSEN JAHRO-BEL-Belgique / VJJF
- 3- NIKOLAUS BICHLER / VOSTA SEBASTIAN-AUT-Autriche
- 3- BERHAULT RONAN / BERHAULT YOHANN-FRA-France
- 5- HALPERN NADEL MICHAEL / MADEN CHRISTIAN-DEN-DANEMARK
- 5- ZABJEK JURE / OBRADOVIC ZAN-SLO-SLOVENIE

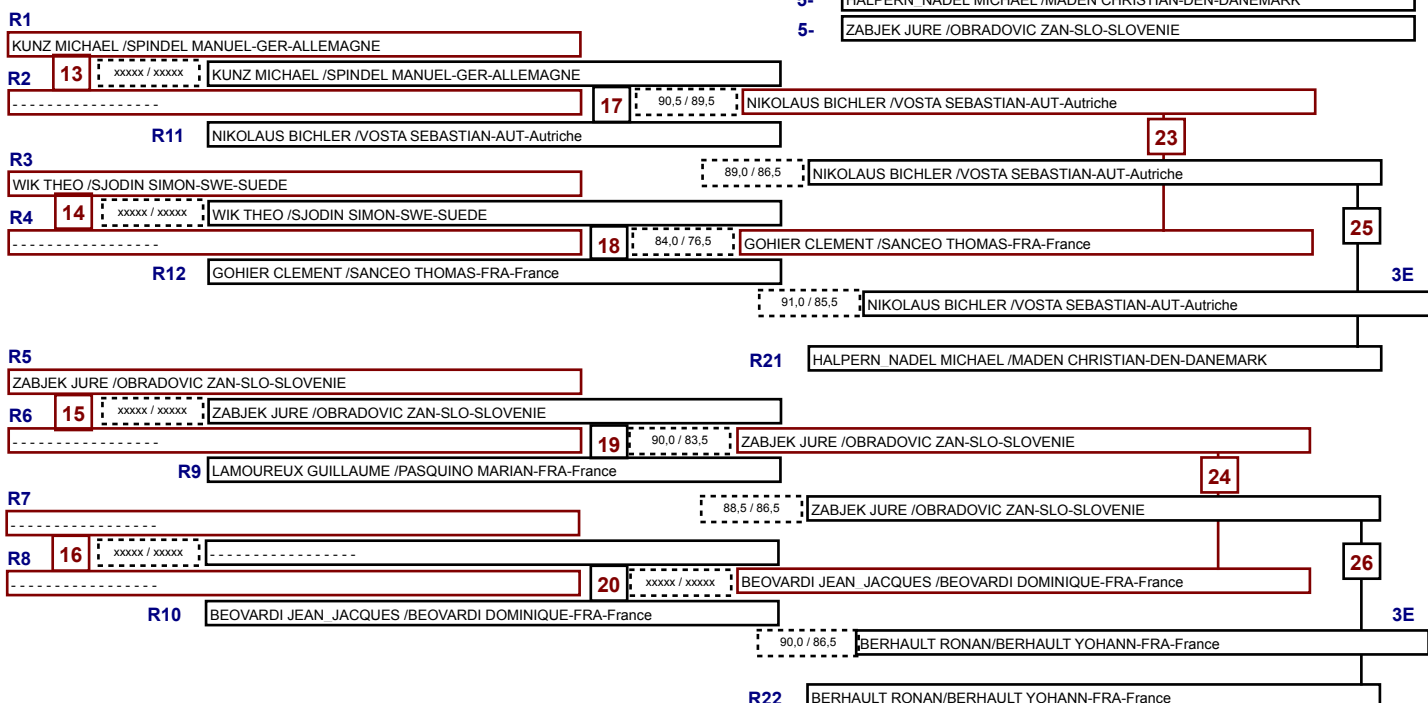

R22 BERHAULT RONAN / BERHAULT YOHANN-FRA-France

JOKL SOFIA /SCHONENBERGER Thomas-SUI-SUISSE	
1 90,5 / 84,5	JOKL SOFIA /SCHONENBERGER Thomas-SUI-SUISSE
REJZIK DANIEL /HORAK JACQUELINE-AUT-Autriche	
7 90,5 / 86,0	JOKL SOFIA /SCHONENBERGER Thomas-SUI-SUISSE
FORT CYNTHIA /FORT JEREMY-FRA-France	
2 87,5 / 85,5	FORT CYNTHIA /FORT JEREMY-FRA-France
SPRUDERER ANNA/NEUMAIER MICHAEL-GER-ALLEMAGNE	
11 90,5 / 84,5	JOKL SOFIA /SCHONENBERGER Thomas-SUI-SUISSE
STALEBRING RONNIE /PERSSON MALIN FREDRIK-SWE-SUEDE	
3 87,0 / 86,0	GRUBER ANDREA /RIEGL GERNOT-AUT-Autriche
GRUBER ANDREA /RIEGL GERNOT-AUT-Autriche	
8 91,5 / 84,5	ZAGORSKI Domenika /ISMER Tom-GER-ALLEMAGNE
BAUDENS AURELIE /CLAIRET HUGO-FRA-France	
4 91,0 / 82,0	ZAGORSKI Domenika /ISMER Tom-GER-ALLEMAGNE
ZAGORSKI Domenika /ISMER Tom-GER-ALLEMAGNE	

1ER

CLASSEMENT

- 1- JOKL SOFIA /SCHONENBERGER Thomas-SUI-SUISSE
- 2- ZAGORSKI Domenika /ISMER Tom-GER-ALLEMAGNE
- 3- SPRUDERER ANNA/NEUMAIER MICHAEL-GER-ALLEMAGNE
- 3- STALEBRING RONNIE /PERSSON MALIN FREDRIK-SWE-SUEDE
- 5- GRUBER ANDREA /RIEGL GERNOT-AUT-Autriche
- 5- FORT CYNTHIA /FORT JEREMY-FRA-France

nb= 8 - Tableau repêchage intégral

R1	REJZIK DANIEL /HORAK JACQUELINE-AUT-Autriche	
	5 87,0 / 86,0	SPRUDERER ANNA/NEUMAIER MICHAEL-GER-ALLEMAGNE
R2	SPRUDERER ANNA/NEUMAIER MICHAEL-GER-ALLEMAGNE	
	9 86,5 / 85,0	SPRUDERER ANNA/NEUMAIER MICHAEL-GER-ALLEMAGNE
	R8	GRUBER ANDREA /RIEGL GERNOT-AUT-Autriche
R3	STALEBRING RONNIE /PERSSON MALIN FREDRIK-SWE-SUEDE	
	6 85,5 / 77,5	STALEBRING RONNIE /PERSSON MALIN FREDRIK-SWE-SUEDE
R4	BAUDENS AURELIE /CLAIRET HUGO-FRA-France	
	10 82,0 / 81,5	STALEBRING RONNIE /PERSSON MALIN FREDRIK-SWE-SUEDE
	R7	FORT CYNTHIA /FORT JEREMY-FRA-France

3E

3E

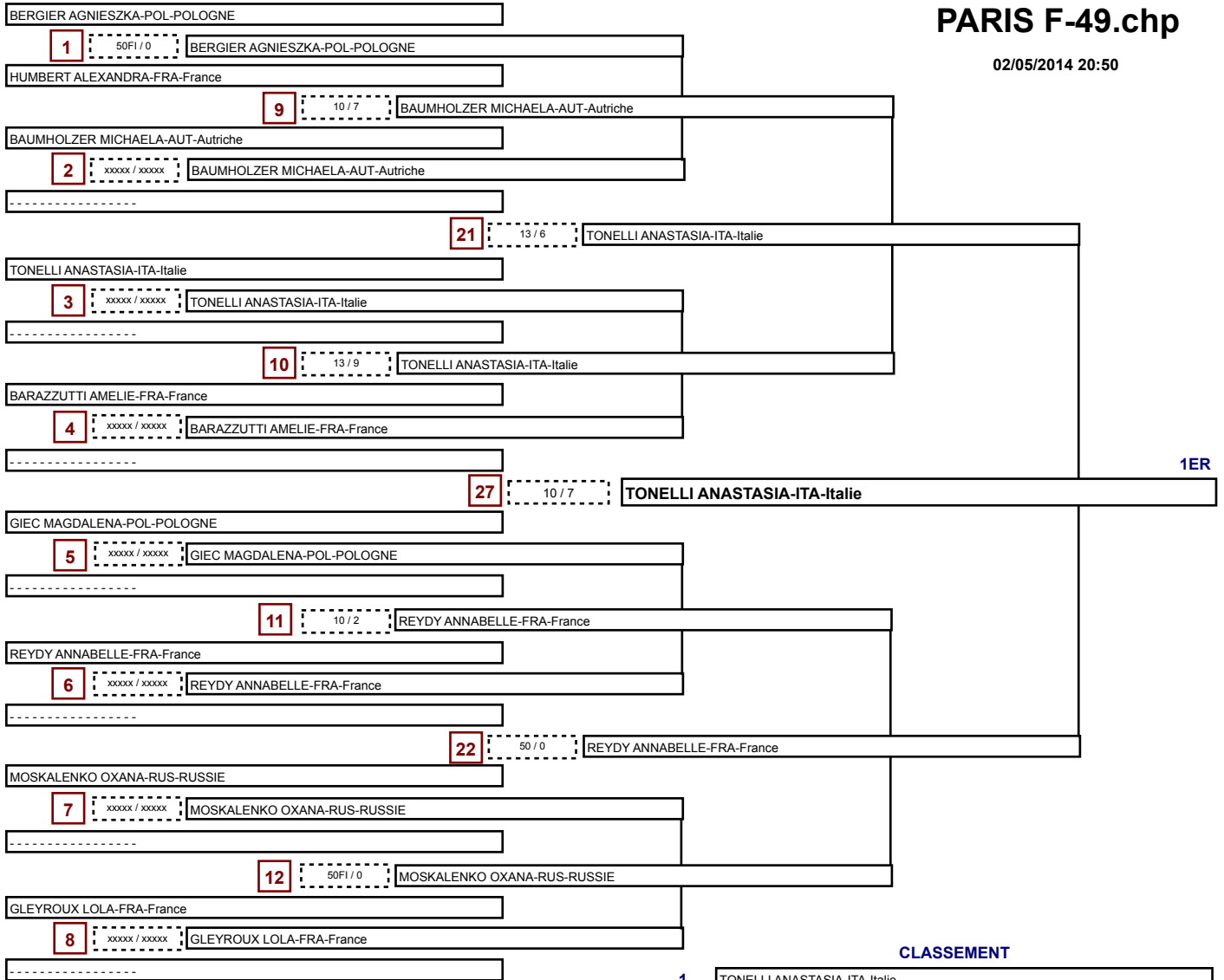

1ER

nb= 9 - combattants - repêchage intégral

CLASSEMENT

- 1- TONELLI ANASTASIA-ITA-Italie
- 2- REYDY ANNABELLE-FRA-France
- 3- GLEYROUX LOLA-FRA-France
- 3- BERGIER AGNIESZKA-POL-POLOGNE
- 5- BAUMHOLZER MICHAELA-AUT-Autriche
- 5- MOSKALENKO OXANA-RUS-RUSSIE

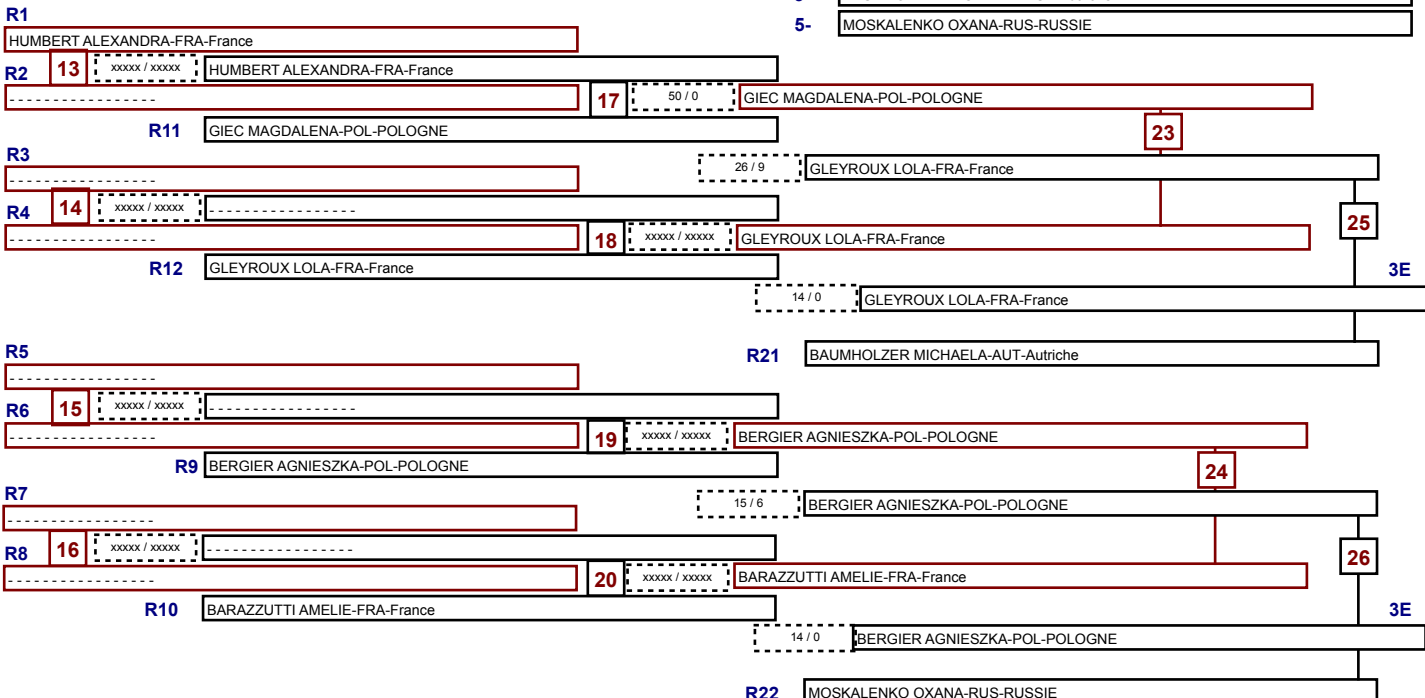

R22

MOSKALENKO OXANA-RUS-RUSSIE

BLANC MURIEL-SWE-SUISSE	1
BEKHER MARIA-RUS-RUSSIE	2
BEAUCHET LAURE-FRA-France	3
PIRC IRMA-SLO-SLOVENIE	4
DAHL REBEKA-DEN-DANEMARK	5

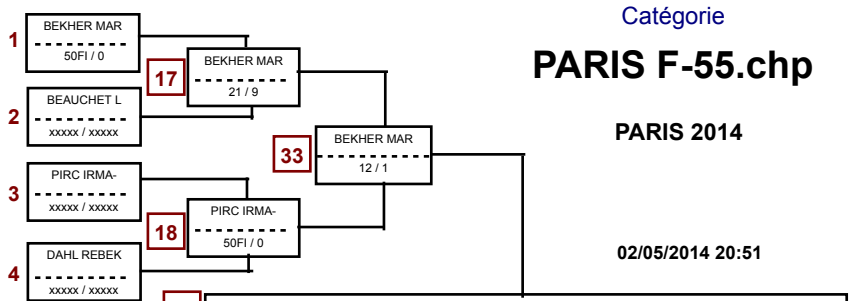

ARENBERGH PEETERS CHABELI-NED-PAYS-BAS	6
DE NYS SHALINI-BEL-Belgique / VJF	7
POYARD MARGAUX-FRA-France	8
MESSENGEN AGNES-FRA-France	9
SCRICCILO JESSICA-ITA-Italie	10

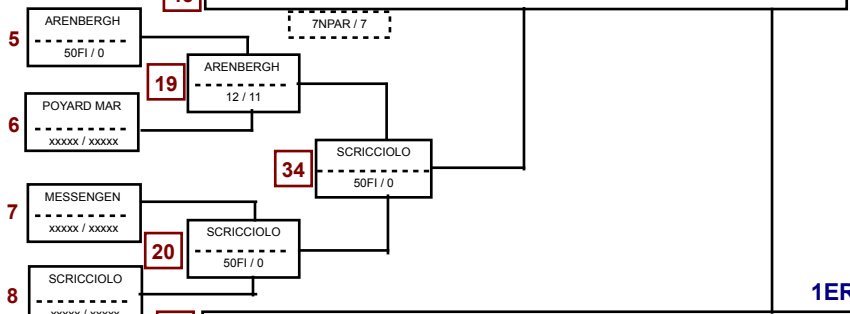

SCHREUDER LIZA-NED-PAYS-BAS	11
BIERONSKA MARTYNA-POL-POLOGNE	12
CAMPAGNE LAURE-FRA-France	13
WITTICH CHARLOTTE-GER-ALLEMAGNE	14
LO RE FRANCESCA-ITA-Italie	15

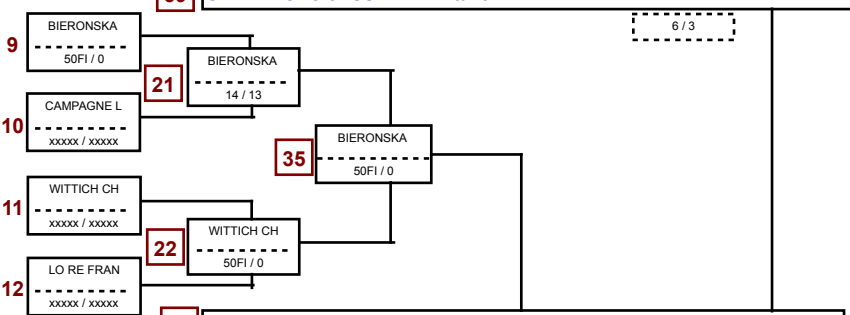

PASSAGE RAEFEN-NED-PAYS-BAS	16
VEJLGGRD LAURA-DEN-DANEMARK	17
LABARDE CLAIRE-FRA-France	18
RESTANO ALESSANDRA-ITA-Italie	19

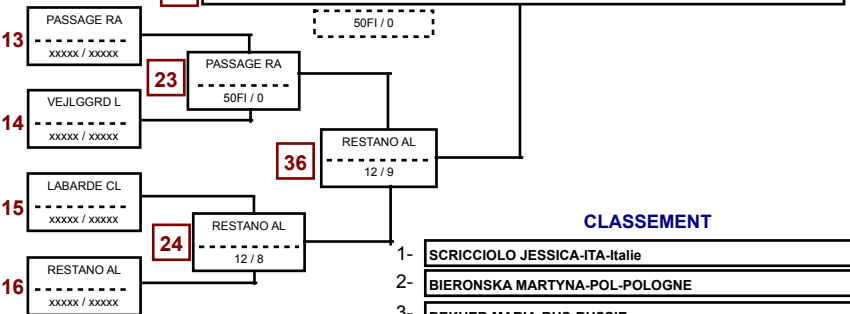

nb = 19 - combattants - repêchage intégral

R13	25	xxxxx/xxxxx	BEAUCHET LAURE-FRA-France
R14	37	xxxxx/xxxxx	BEAUCHET LAURE-FRA-France
R15	47	50F1/0	BEAUCHET LAURE-FRA-France
R16	26	xxxxx/xxxxx	DAHL REBEKA-DEN-DANEMARK
R17	38	xxxxx/xxxxx	DAHL REBEKA-DEN-DANEMARK
R18	51	17/3	WITTICH CHARLOTTE-GER-ALLEMAGNE
R9	27	xxxxx/xxxxx	SCHREUDER LIZA-NED-PAYS-BAS
R10	39	8/7	POYARD MARGAUX-FRA-France
R11	48	9/6	MESSENGEN AGNES-FRA-France
R12	40	xxxxx/xxxxx	MESSENGEN AGNES-FRA-France
R5	29	xxxxx/xxxxx	DE NYS SHALINI-BEL-Belgique / VJF
R6	41	50F1/0	CAMPAGNE LAURE-FRA-France
R7	30	xxxxx/xxxxx	CAMPAGNE LAURE-FRA-France
R8	42	xxxxx/xxxxx	LO RE FRANCESCA-ITA-Italie
R1	31	xxxxx/xxxxx	BLANC MURIEL-SWE-SUISSE
R2	43	50F1/0	VEJLGGRD LAURA-DEN-DANEMARK
R3	32	xxxxx/xxxxx	VEJLGGRD LAURA-DEN-DANEMARK
R4	44	xxxxx/xxxxx	LABARDE CLAIRE-FRA-France

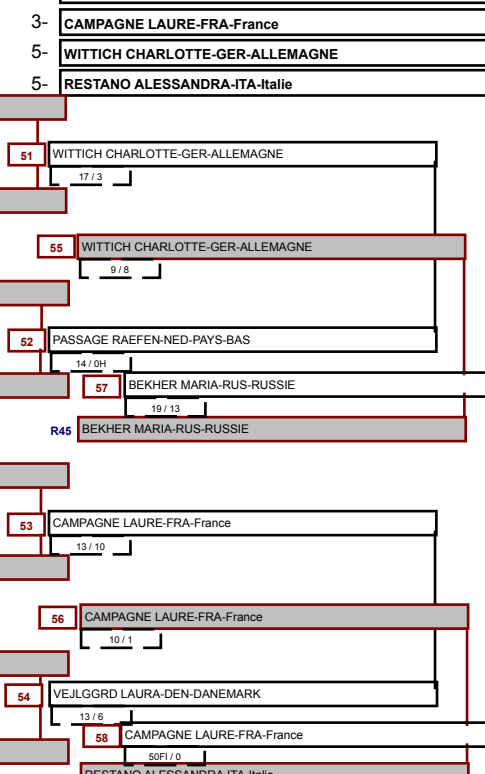

1ER

6/3

### CLASSEMENT

- 1- SCRICCILO JESSICA-ITA-Italie
- 2- BIERONSKA MARTYNA-POL-POLOGNE
- 3- BEKHER MARIA-RUS-RUSSIE
- 3- CAMPAGNE LAURE-FRA-France
- 5- WITTICH CHARLOTTE-GER-ALLEMAGNE
- 5- RESTANO ALESSANDRA-ITA-Italie

3E

3E

THOUMSIN LUDIVINE-BEL-Belgique			
<b>1</b> 50F1 / 0	STIPOSEK BARBARA-SLO-SLOVENIE		
STIPOSEK BARBARA-SLO-SLOVENIE			
<b>9</b> 50F1 / 0	NEBIE SEVERINE-FRA-France		
CAVARRETTA ANNALISA-ITA-Italie			
<b>2</b> 50F1 / 0	NEBIE SEVERINE-FRA-France		
NEBIE SEVERINE-FRA-France			
<b>21</b> 50F1 / 0	NEBIE SEVERINE-FRA-France		
GESPERINI VIOLA-ITA-Italie			
<b>3</b> 12 / 5	GESPERINI VIOLA-ITA-Italie		
BEN SALAH JAMILA-FRA-France			
<b>10</b> 50F1 / 0	SONNEMANN Mandy-GER-ALLEMAGNE		
JOHANSSON SANNA-SWE-SUEDE			
<b>4</b> 50F1 / 0	SONNEMANN Mandy-GER-ALLEMAGNE		
SONNEMANN Mandy-GER-ALLEMAGNE			
<b>27</b> 50F1 / 0	NEBIE SEVERINE-FRA-France		1ER
CERBINI ALESSANDRA-ITA-Italie			
<b>5</b> 12 / 8	CERBINI ALESSANDRA-ITA-Italie		
DEROBERT LEA-FRA-France			
<b>11</b> 50F1 / 0	FERREIRA JULIANA-FRA-France		
SUDARIKOVA ALINA-RUS-RUSSIE			
<b>6</b> 8 / 2	FERREIRA JULIANA-FRA-France		
FERREIRA JULIANA-FRA-France			
<b>22</b> 50F1 / 0	NEUPERT Carina-GER-ALLEMAGNE		
BARTOCETTI ALICE-ITA-Italie			
<b>7</b> 12 / 6	MONCHAUZOU MAI LINE-FRA-France		
MONCHAUZOU MAI LINE-FRA-France			
<b>12</b> 50F1 / 0	NEUPERT Carina-GER-ALLEMAGNE		
JELIC LARA-SLO-SLOVENIE			
<b>8</b> 50F1 / 0	NEUPERT Carina-GER-ALLEMAGNE		
NEUPERT Carina-GER-ALLEMAGNE			

nb = 16 - combattants - repêchage intégral

CLASSEMENT

1-	NEBIE SEVERINE-FRA-France
2-	NEUPERT Carina-GER-ALLEMAGNE
3-	SONNEMANN Mandy-GER-ALLEMAGNE
3-	FERREIRA JULIANA-FRA-France
5-	CAVARRETTA ANNALISA-ITA-Italie
5-	BARTOCETTI ALICE-ITA-Italie

<b>R1</b>	THOUMSIN LUDIVINE-BEL-Belgique		
<b>R2</b> <b>13</b> 50F1 / 0	CAVARRETTA ANNALISA-ITA-Italie		
CAVARRETTA ANNALISA-ITA-Italie	<b>17</b> 10 / 3	CAVARRETTA ANNALISA-ITA-Italie	
<b>R11</b>	CERBINI ALESSANDRA-ITA-Italie	<b>23</b>	
<b>R3</b>	BEN SALAH JAMILA-FRA-France	12 / 10	CAVARRETTA ANNALISA-ITA-Italie
<b>R4</b> <b>14</b> 50F1 / 0	BEN SALAH JAMILA-FRA-France		
JOHANSSON SANNA-SWE-SUEDE	<b>18</b> 11 / 5	MONCHAUZOU MAI LINE-FRA-France	<b>25</b>
<b>R12</b>	MONCHAUZOU MAI LINE-FRA-France		
	50F1 / 0	SONNEMANN Mandy-GER-ALLEMAGNE	<b>3E</b>
<b>R5</b>	DEROBERT LEA-FRA-France	<b>R21</b>	SONNEMANN Mandy-GER-ALLEMAGNE
<b>R6</b> <b>15</b> 9 / 3	SUDARIKOVA ALINA-RUS-RUSSIE		
SUDARIKOVA ALINA-RUS-RUSSIE	<b>19</b> 11 / 10	STIPOSEK BARBARA-SLO-SLOVENIE	
<b>R9</b>	STIPOSEK BARBARA-SLO-SLOVENIE	<b>24</b>	
<b>R7</b>	BARTOCETTI ALICE-ITA-Italie	50F1 / 0	BARTOCETTI ALICE-ITA-Italie
<b>R8</b> <b>16</b> 50F1 / 0	BARTOCETTI ALICE-ITA-Italie		
JELIC LARA-SLO-SLOVENIE	<b>20</b> 15 / 8	BARTOCETTI ALICE-ITA-Italie	<b>26</b>
<b>R10</b>	GESPERINI VIOLA-ITA-Italie		
	15 / 11	FERREIRA JULIANA-FRA-France	<b>3E</b>
<b>R22</b>	FERREIRA JULIANA-FRA-France		

VERHEYEN LAURE-BEL-Belgique / VJF	1
BAUER ANNALENA-GER-ALLEMAGNE	2
CORONESE LAURA-FRA-France	3
IVANOVA ALEKSANDRA-RUS-RUSSIE	4
PETER JOANA-SWE-SUISSE	5

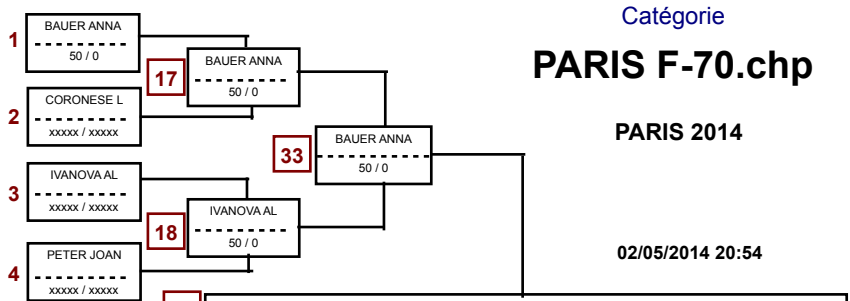

SITKO JUSTYNA-POL-POLOGNE	5
SCHELLINGERHOUT CYNTHIA-NED-PAYS-BAS	6
MOUTEL PAULINE-FRA-France	7
BILLGER SOFIA-SWE-SUEDE	8

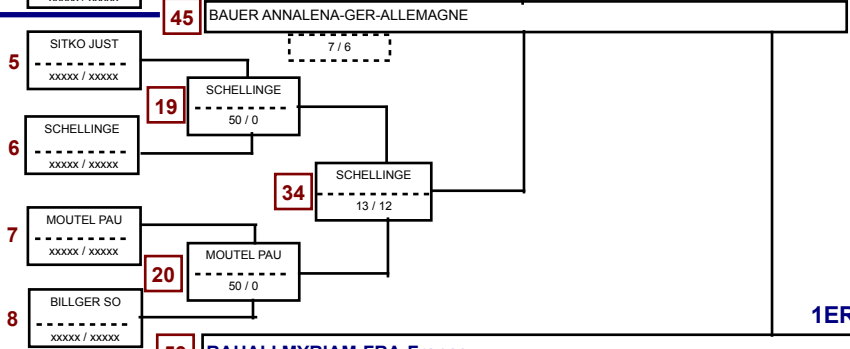

WAUTERS STEFANIE-BEL-Belgique / VJF	9
RAHALI MYRIAM-FRA-France	10
BOCO LAURA-ITA-Italie	11
SAND JOHANNA-SWE-SUEDE	12

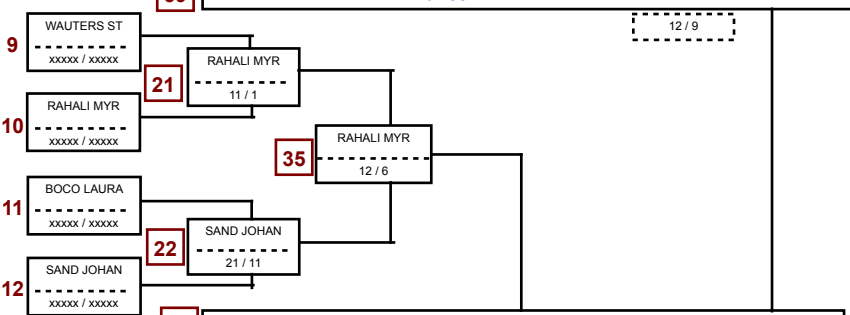

MACKOWIAK EMILIA-POL-POLOGNE	13
VAN LEEUWEN Aafke-NED-PAYS-BAS	14
BRUNET JULIE-FRA-France	15
FIEDLER MARTINA-GER-ALLEMAGNE	16

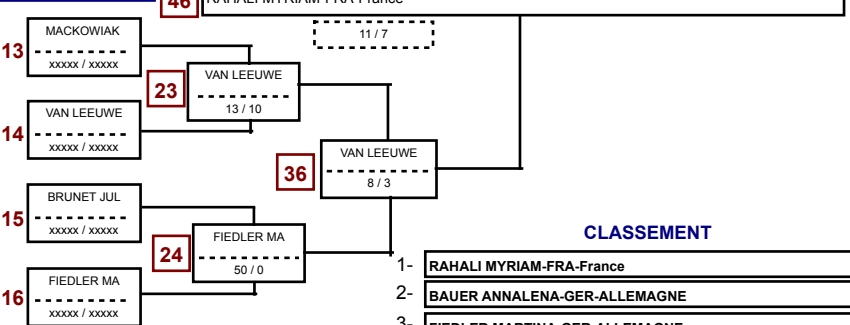

nb = 17 - combattants - repêchage intégral

R13	25	xxxxx/xxxxx	
R14	37	xxxxx/xxxxx	CORONESE LAURA-FRA-France
R15	R17		CORONESE LAURA-FRA-France
R16	26	xxxxx/xxxxx	
R16	R18		PETER JOANA-SWE-SUISSE
R9	27	xxxxx/xxxxx	
R10	R19		SITKO JUSTYNA-POL-POLOGNE
R11	28	xxxxx/xxxxx	
R12	40	xxxxx/xxxxx	BILLGER SOFIA-SWE-SUEDE
R5	29	xxxxx/xxxxx	
R6	41	xxxxx/xxxxx	WAUTERS STEFANIE-BEL-Belgique / VJF
R7	30	xxxxx/xxxxx	
R8	42	xxxxx/xxxxx	BOCO LAURA-ITA-Italie
R1	31	xxxxx/xxxxx	VERHEYEN LAURE-BEL-Belgique / VJF
R2	43	50/0	MACKOWIAK EMILIA-POL-POLOGNE
R3	32	xxxxx/xxxxx	
R4	44	xxxxx/xxxxx	BRUNET JULIE-FRA-France
R24			BRUNET JULIE-FRA-France

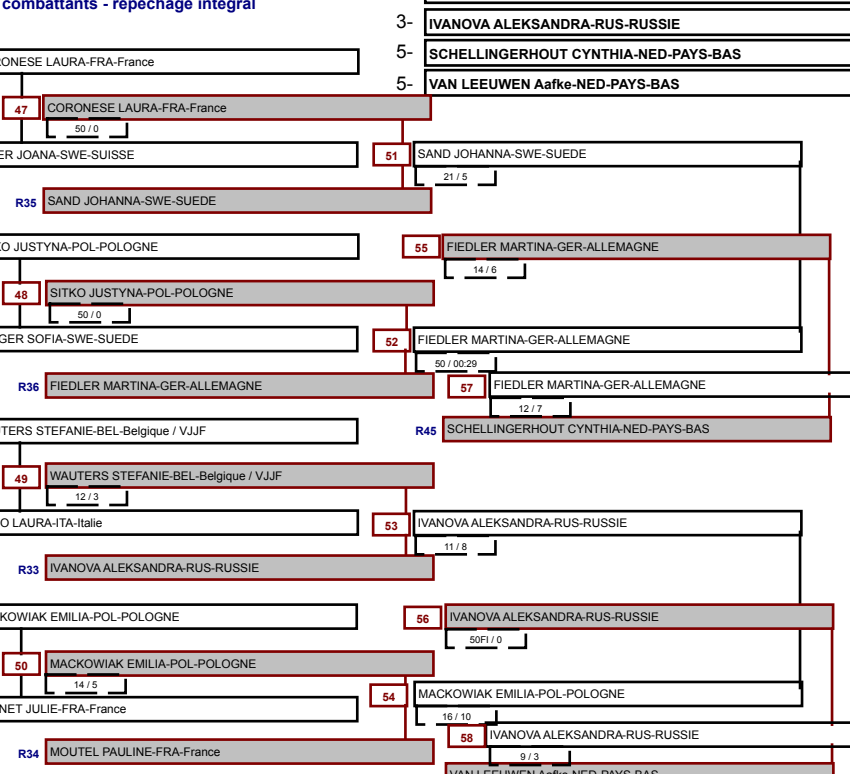

1ER

### CLASSEMENT

1-	RAHALI MYRIAM-FRA-France
2-	BAUER ANNALENA-GER-ALLEMAGNE
3-	FIEDLER MARTINA-GER-ALLEMAGNE
3-	IVANOVA ALEKSANDRA-RUS-RUSSIE
5-	SCHELLINGERHOUT CYNTHIA-NED-PAYS-BAS
5-	VAN LEEUWEN Aafke-NED-PAYS-BAS

3E

3E

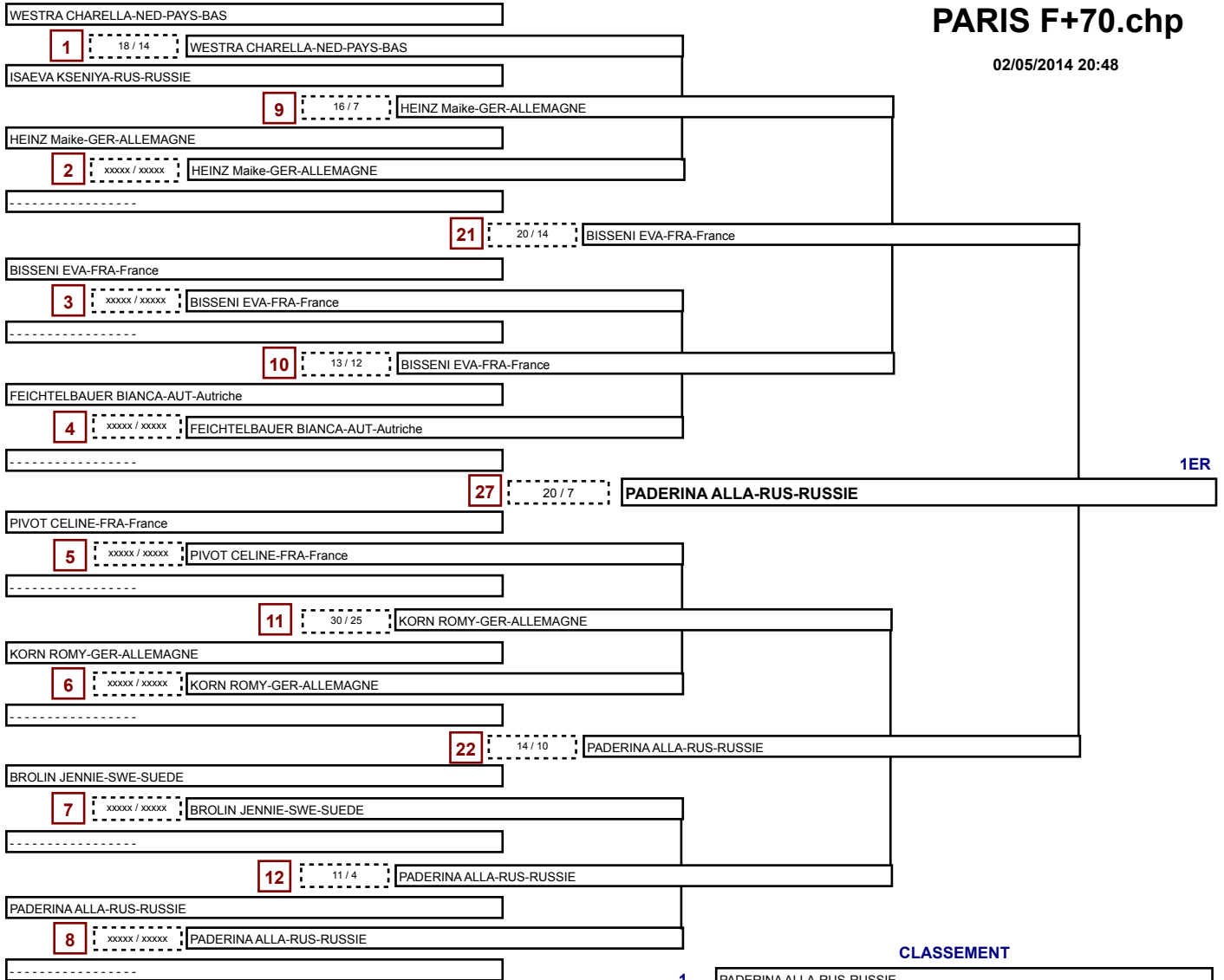

1ER

CLASSEMENT

- 1- PADERINA ALLA-RUS-RUSSIE
- 2- BISSENI EVA-FRA-France
- 3- HEINZ Maike-GER-ALLEMAGNE
- 3- KORN ROMY-GER-ALLEMAGNE
- 5- BROLIN JENNIE-SWE-SUEDE
- 5- WESTRA CHARELLA-NED-PAYS-BAS

nb= 9 - combattants - repêchage intégral

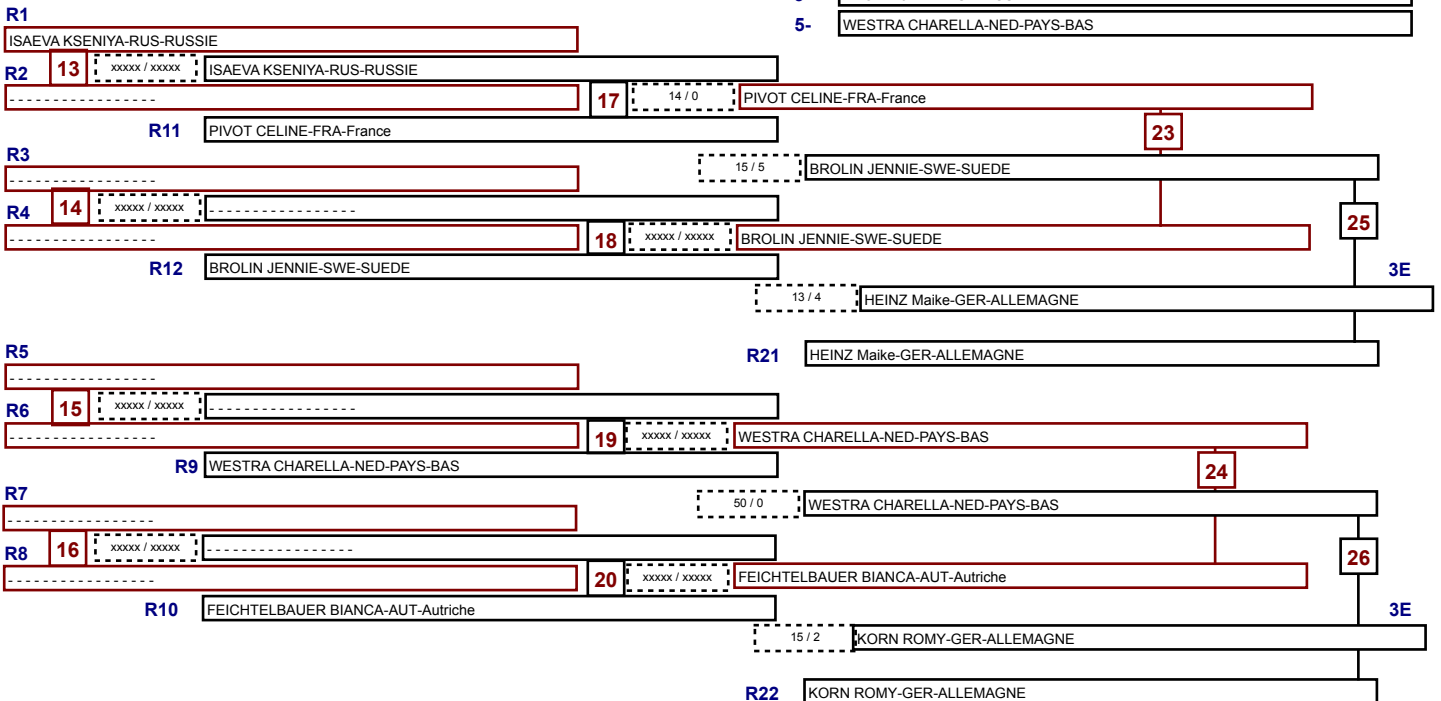

3E

3E



**PARIS M-56**

02/05/2014 20:57

	Nom - zone - club	1 2	3 1	2 3	nb Vict Points	CLASS.
1	MOCHULSKYI BOHDAN-UKR-UKRAINE	0 17	1 9		1 26	2
2	CHAZETTE ROMAIN-FRA-France	1 17NPAR		1 50	2 67	1
3	ACBARD JULIEN-FRA-France		0 6	0 0	0 6	3

**A**

xxxxOrdre des matches : 1A x 2A - 1B x 2B - 3A x 1A - 3B x 1B - 2A x 3A - 2B x 3B

	Nom - zone - club	1 2	3 1	2 3	nb Vict Points	CLASS.
1	TZANIKIAN ARA-GRE-GRECE	0 0	1 14		1 14	2
2	PEDERSEN BO-DEN-DANEMARK	1 14		0 8	1 22	1
3	BIGAIGNON MARVYN-FRA-France		0 0H	1 9	1 9	3

**B**

Tableau final

CHAZETTE ROMAIN-FRA-France

50 / 00:20

CHAZETTE ROMAIN-FRA-France

TZANIKIAN ARA-GRE-GRECE

10 / 73:00

CHAZETTE ROMAIN-FRA-France

Pause avant le match suivant

PEDERSEN BO-DEN-DANEMARK

18 / 70:00

MOCHULSKYI BOHDAN-UKR-UKRAINE

MOCHULSKYI BOHDAN-UKR-UKRAINE

CLASSEMENT

- 1- CHAZETTE ROMAIN-FRA-France
- 2- MOCHULSKYI BOHDAN-UKR-UKRAINE
- 3- TZANIKIAN ARA-GRE-GRECE
- 3- PEDERSEN BO-DEN-DANEMARK
- 5- ACBARD JULIEN-FRA-France
- 5- BIGAIGNON MARVYN-FRA-France

# PARIS M-62.chp

PARIS 2014

02/05/2014 20:59

DALAA YAZID-BEL-Belgique / VJJF	1
MENUET CHARLY-FRA-France	2
SALMANOV JASCHAR-GER-ALLEMAGNE	3
REPETTO MATTEO-ITA-Italie	4
MATHIEU JULIEN-FRA-France	5

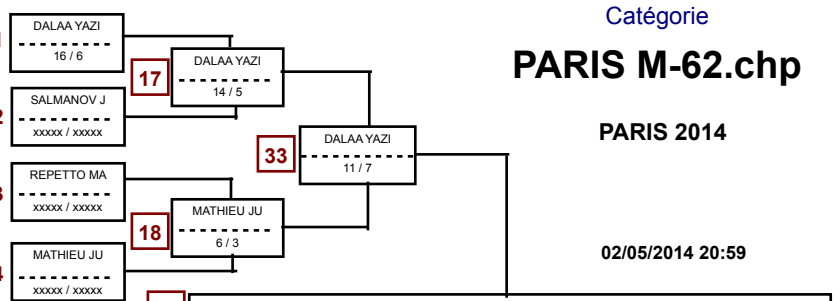

HERASKIN MAKSYM-UKR-UKRAINE	5
ANDERT PHAN TRINH PATRIK-SWE-SUEDE	6
WALTER Axel-GER-ALLEMAGNE	7
MUNOZ THOMAS-FRA-France	8

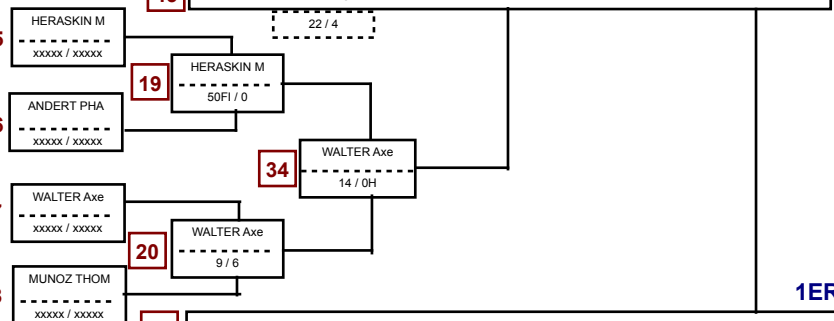

VAN SNICK ARNAUD-BEL-Belgique	9
HAIDER OLIVER-AUT-Autriche	10
MACHADO RUI-POR-Portugal	11
CHEKUROV SERGEY-RUS-RUSSIE	12
BEN ALI FARID-FRA-France	13

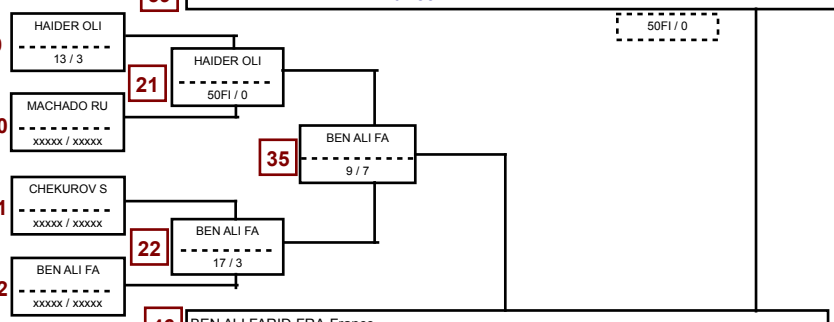

MONTARANI MATTEO-ITA-Italie	13
EL KABIR OMAR-FRA-France	14
APOLONOV Roman-GER-ALLEMAGNE	15
MARTIN ANTHONY-FRA-France	16

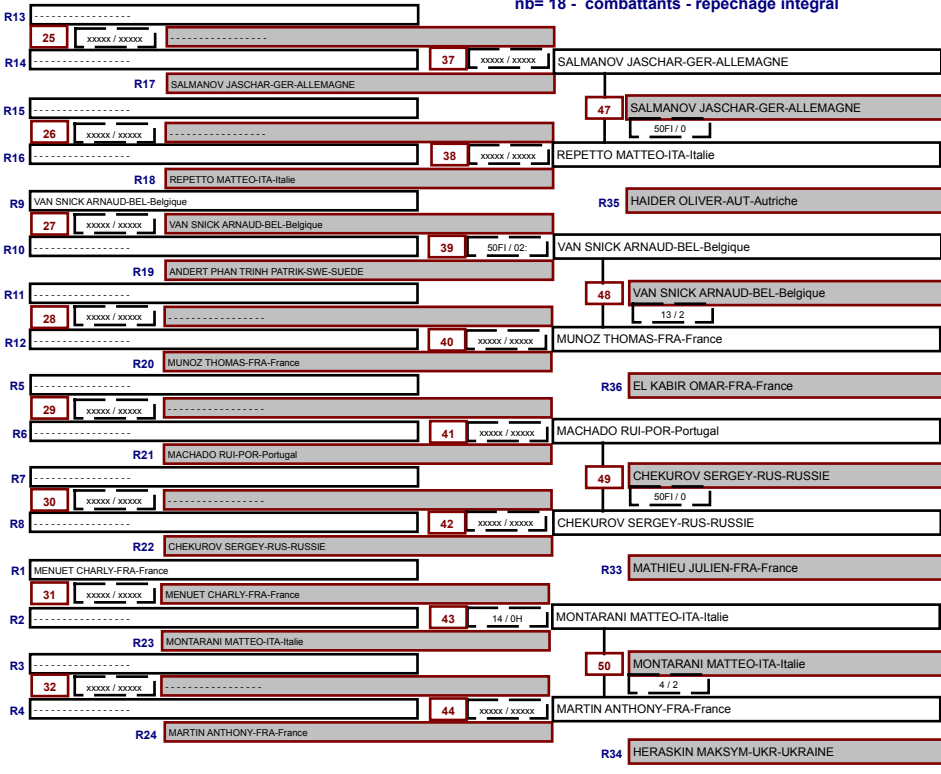
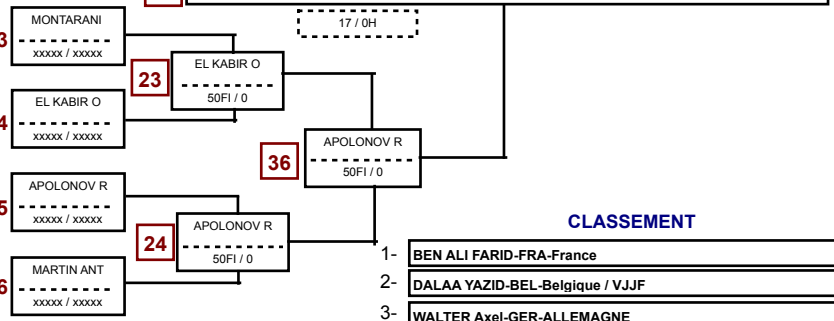

1ER

## CLASSEMENT

1-	BEN ALI FARID-FRA-France
2-	DALAA YAZID-BEL-Belgique / VJJF
3-	WALTER Axel-GER-ALLEMAGNE
3-	APOLONOV Roman-GER-ALLEMAGNE
5-	SALMANOV JASCHAR-GER-ALLEMAGNE
5-	CHEKUROV SERGEY-RUS-RUSSIE

3E

3E

# PARIS M-69.chp

PARIS 2014

02/05/2014 21:01

DELANGE Tom-BEL-Belgique / VJF
CHERVONIASHCHYI VLADYSLAV-UKR-UKRAINE
BONNEAU VALENTIN-FRA-France
-----
FROWYN BRIAN-NED-PAYS-BAS
AUMULLER JOHANNES-GER-ALLEMAGNE
MANUKYAN MGER-RUS-RUSSIE
-----

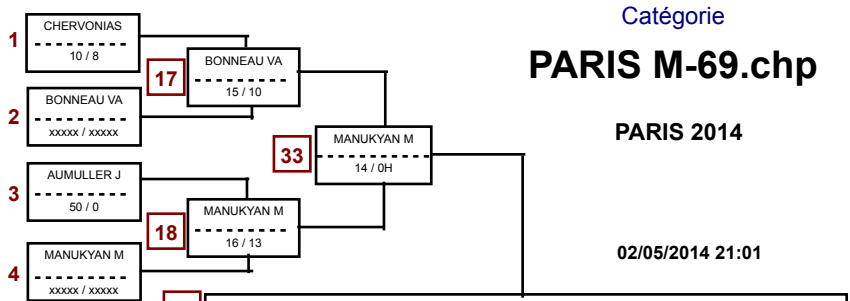

VAN VELZEN Rick-NED-PAYS-BAS
FARIA JOAQUIM-POR-Portugal
SEHIL YACINE-FRA-France
-----
SANGIOTIS CHRISTOS-GRE-GRECE
BEYER NIKOLAJ-DEN-DANEMARK
BESHENETC DIMITRII-RUS-RUSSIE
-----

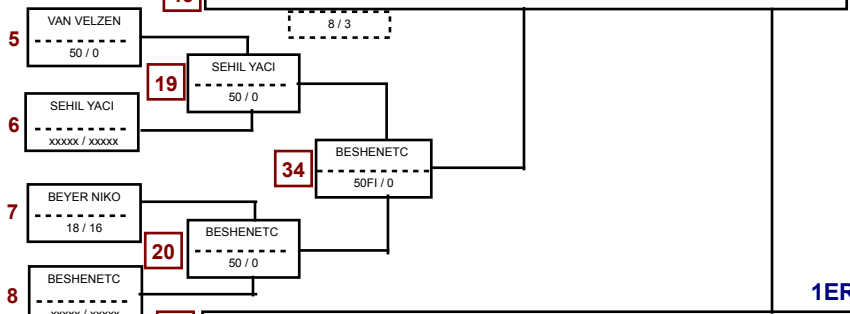

SEMIONOV YURI-BEL-Belgique / VJF
GROS GRZEGORZ-POL-POLOGNE
COUSIN ROMAIN-FRA-France
-----
LINGEN MIKE-NED-PAYS-BAS
GARBRANDS CHRISTOPHER-GER-ALLEMAGNE
KORZHAVYKH PAVEL-RUS-RUSSIE
-----

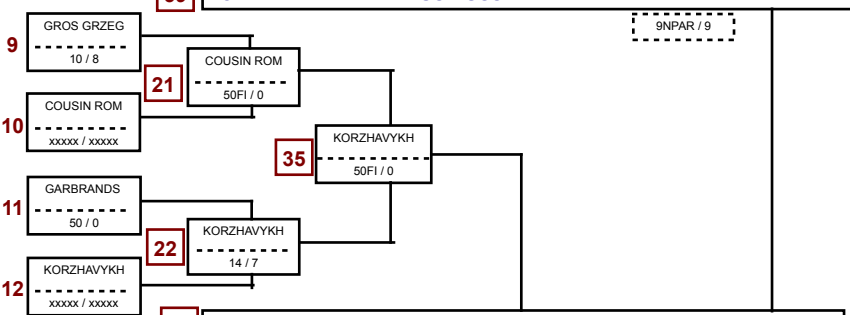

VOGELZANG BOY-NED-PAYS-BAS
REICHERT Alexander-GER-ALLEMAGNE
GARNIER MICHAEL-FRA-France
-----
VENON FABIEN-FRA-France
ERIKSSON JONATAN-SWE-SUEDE
JERMAN TADEJ-SLO-SLOVENIE
-----

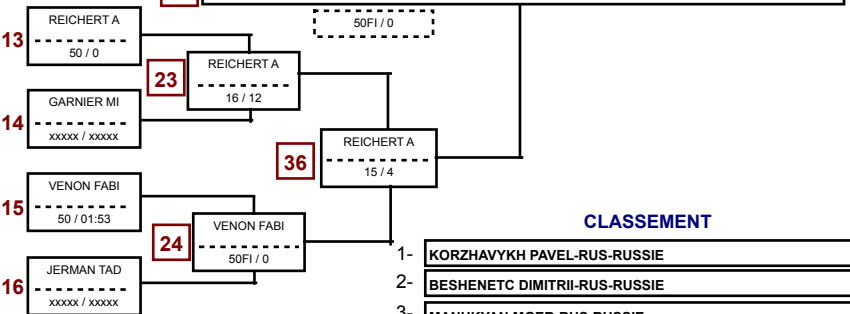

nb = 24 - combattants - repêchage intégral

R13	VOGELZANG BOY-NED-PAYS-BAS	25	14 / 0H
R14	VOGELZANG BOY-NED-PAYS-BAS	37	14 / 0H
R15	ERIKSSON JONATAN-SWE-SUEDE	26	16 / 8
R16	ERIKSSON JONATAN-SWE-SUEDE	38	50F1 / 0
R9	SEMIONOV YURI-BEL-Belgique / VJF	27	13 / 7
R10	SEMIONOV YURI-BEL-Belgique / VJF	39	50F1 / 0
R11	LINGEN MIKE-NED-PAYS-BAS	28	16 / 0H
R12	LINGEN MIKE-NED-PAYS-BAS	40	16 / 0H
R5	FARIA JOAQUIM-POR-Portugal	29	17 / 7
R6	FARIA JOAQUIM-POR-Portugal	41	17 / 7
R7	SANGIOTIS CHRISTOS-GRE-GRECE	30	50F1 / 0
R8	SANGIOTIS CHRISTOS-GRE-GRECE	42	50F1 / 0
R1	DELANGE Tom-BEL-Belgique / VJF	31	10 / 4
R2	DELANGE Tom-BEL-Belgique / VJF	43	10 / 4
R3	FROWYN BRIAN-NED-PAYS-BAS	32	18 / 3
R4	FROWYN BRIAN-NED-PAYS-BAS	44	18 / 3

### CLASSEMENT

1-	KORZHAVYKH PAVEL-RUS-RUSSIE
2-	BESHENETC DIMITRII-RUS-RUSSIE
3-	MANUKYAN MGER-RUS-RUSSIE
3-	REICHERT Alexander-GER-ALLEMAGNE
5-	COUSIN ROMAIN-FRA-France
5-	GARNIER MICHAEL-FRA-France

1ER

3E

3E

# PARIS M-77.chp

PARIS 2014

02/05/2014 21:04

1	GUILLAUME GAUTIER-FRA-France
2	VORONTSOV MAXIM-RUS-RUSSIE
3	ARMINO LORENZO-ITA-Italie
4	SLATNER RAPHAEL-AUT-Autriche
5	KUNSA PERCY-FRA-France
6	PETRITSCH FLORIAN-SUI-SUISSE
7	KARAGIANNIS ATHANASIOS-GRE-GRECE
8	JENSEN EMIL-DEN-DANEMARK

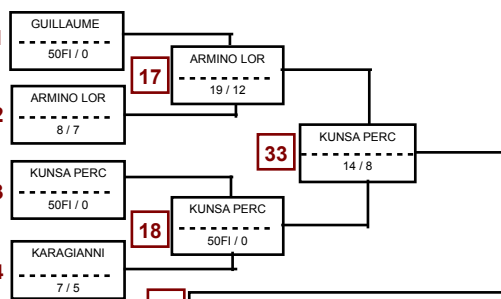

5	MANSON CHRISTOPHE-FRA-France
6	RYSSEL Max-GER-ALLEMAGNE
7	VAN DEN BREMPT WILLIAM-BEL-Belgique / VJJF
8	MATHIASEN DANNY-DEN-DANEMARK
9	PAGANO EMANUELE-ITA-Italie
10	DE GIER JOHAN-NED-PAYS-BAS
11	KHARITONOV NIKITA-RUS-RUSSIE
12	-----

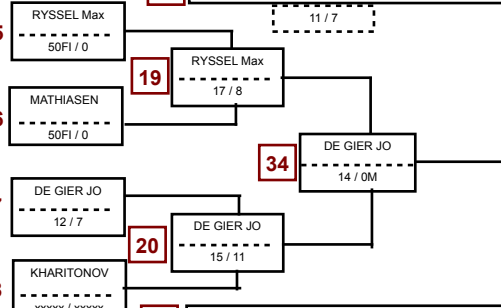

9	GERMER MAXIM-FRA-France
10	KNEBL ANDREAS-GER-ALLEMAGNE
11	MICHAUX AYRTON-BEL-Belgique / VJJF
12	HAIDER Thomas-AUT-Autriche
13	MUSSARD CEDRIC-FRA-France
14	WIDGREN FREDRIK-SWE-SUEDE
15	EVTIKHOV MIKHAIL-RUS-RUSSIE
16	-----

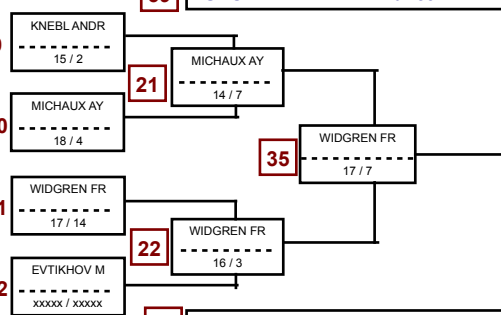

13	MARTY SEBASTIEN-FRA-France
14	JORG LUKAS-GER-ALLEMAGNE
15	ZIGOURAS CHRISTOS-GRE-GRECE
16	MUSTAFA ADAM-DEN-DANEMARK
17	CIRELLI LUCA-ITA-Italie
18	WEEMAES FREDDY-NED-PAYS-BAS
19	BOROK ILIA-RUS-RUSSIE
20	-----

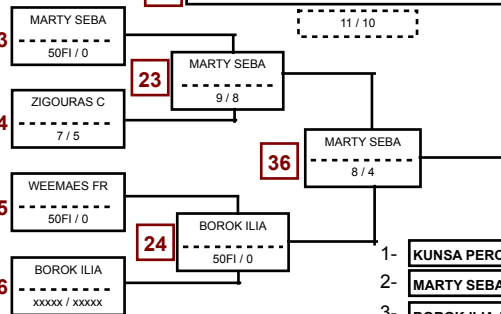

nb= 29 - combattants - repêchage intégral

R13	JORG LUKAS-GER-ALLEMAGNE	25	50F/00	MUSTAFA ADAM-DEN-DANEMARK
R14	MUSTAFA ADAM-DEN-DANEMARK	37	14/0	GUILLAUME GAUTIER-FRA-France
R15	CIRELLI LUCA-ITA-Italie	26	xxxxx/xxxxx	CIRELLI LUCA-ITA-Italie
R16	-----	38	50/0	CIRELLI LUCA-ITA-Italie
R9	GERMER MAXIM-FRA-France	27	14/11	GERMER MAXIM-FRA-France
R10	HAIDER Thomas-AUT-Autriche	39	22/0	MATHIASEN DANNY-DEN-DANEMARK
R11	MUSSARD CEDRIC-FRA-France	28	xxxxx/xxxxx	MUSSARD CEDRIC-FRA-France
R12	-----	40	17/6	MUSSARD CEDRIC-FRA-France
R5	MANSON CHRISTOPHE-FRA-France	29	50F/0	MANSON CHRISTOPHE-FRA-France
R6	VAN DEN BREMPT WILLIAM-BEL-Belgique / VJJF	41	14/0H	KNEBL ANDREAS-GER-ALLEMAGNE
R7	PAGANO EMANUELE-ITA-Italie	30	xxxxx/xxxxx	PAGANO EMANUELE-ITA-Italie
R8	-----	42	50F/0	EVTIKHOV MIKHAIL-RUS-RUSSIE
R1	VORONTSOV MAXIM-RUS-RUSSIE	31	4/0	VORONTSOV MAXIM-RUS-RUSSIE
R2	SLATNER RAPHAEL-AUT-Autriche	43	8/6	VORONTSOV MAXIM-RUS-RUSSIE
R3	PETRITSCH FLORIAN-SUI-SUISSE	32	16/11	JENSEN EMIL-DEN-DANEMARK
R4	JENSEN EMIL-DEN-DANEMARK	44	19/11	WEEMAES FREDDY-NED-PAYS-BAS

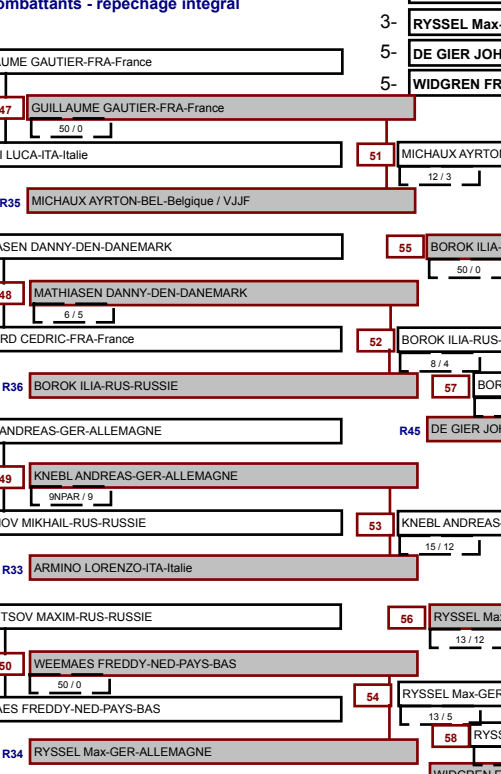

## CLASSEMENT

1-	KUNSA PERCY-FRA-France
2-	MARTY SEBASTIEN-FRA-France
3-	BOROK ILIA-RUS-RUSSIE
3-	RYSSEL Max-GER-ALLEMAGNE
5-	DE GIER JOHAN-NED-PAYS-BAS
5-	WIDGREN FREDRIK-SWE-SUEDE

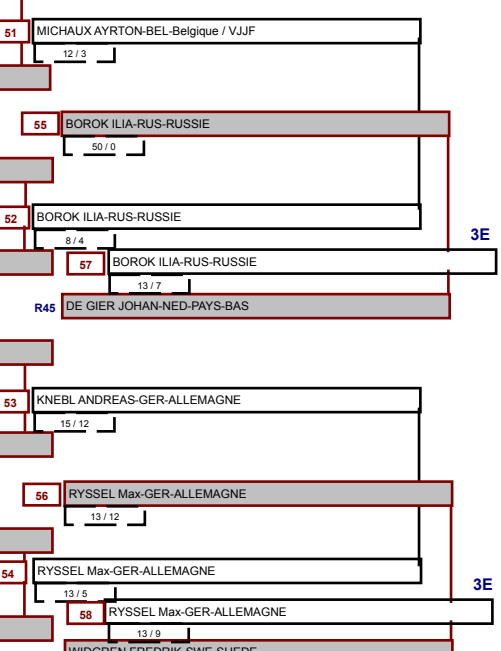

# PARIS M-85.chp

PARIS 2014

02/05/2014 21:05

1	LOUSSIF SAMI-BEL-Belgique / VJJF
2	MUSSARD MICKAEL-FRA-France
3	LUCCHESI FABRIZIO-SWE-SUISSE
4	KRAJEWSKI TOMASZ-POL-POLOGNE
5	GRISHCHENKO DIMITRIY-RUS-RUSSIE
6	MARTY LAURENT-FRA-France
7	CECCHINI DANIELE-ITA-Italie
8	-----

1	LOUSSIF SA 14 / 0M
2	KRAJEWSKI 50FI / 0
3	GRISHCHENK 15NPAR / 15
4	CECCHINI D xxxxx / xxxxx

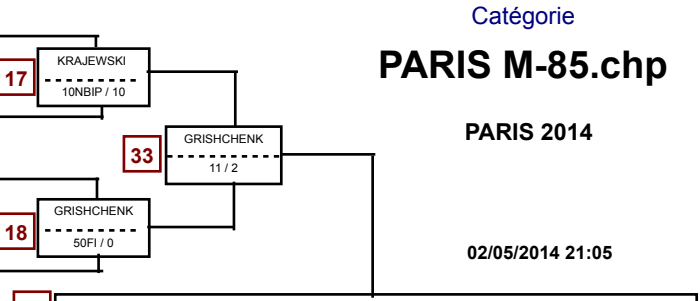

5	DUTRIEUX ALEXANDRE-BEL-Belgique
6	DIEVART THOMAS-FRA-France
7	MEJBORN JONAS-DEN-DANEMARK
8	KARPFINGER PHIL-GER-ALLEMAGNE
9	SETH WENZEL WILLIAM-SWE-SUEDE
10	BAEZ NICOLAS-SUI-SUISSE
11	VRINGER WOUT-NED-PAYS-BAS
12	-----

5	DUTRIEUX A 50FI / 0
6	MEJBORN JO 14 / 0M
7	SETH WENZE 19 / 11
8	VRINGER WO xxxxx / xxxxx

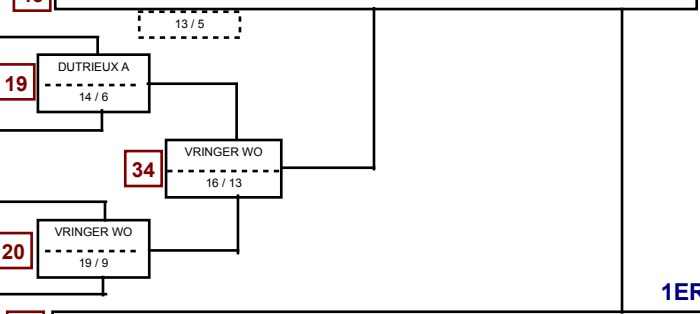

9	ESSOUBHI MIMOUN-BEL-Belgique / VJJF
10	PEREZ ALEXANDRE-FRA-France
11	VASE JAKOB KARGO-DEN-DANEMARK
12	AOUICHI AHMED-TUN-TUNISIE
13	MEDVEDSKOV MAKSIM-RUS-RUSSIE
14	BALTAYAN HERVE-FRA-France
15	CIRELLI MATTIA-ITA-Italie
16	-----

9	ESSOUBHI M 19 / 10
10	VASE JAKOB 50FI / 0
11	MEDVEDSKOV 50FI / 0
12	CIRELLI MA xxxxx / xxxxx

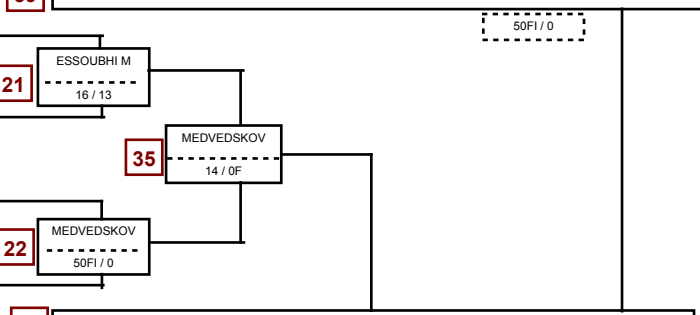

13	HAYRAPETYAN MURAD-ESP-Espagne
14	RIBERE JULIEN-FRA-France
15	WILLARD MIKKEL-DEN-DANEMARK
16	SCHELL Thomas-GER-ALLEMAGNE
17	EBERLE ROBIN-SWE-SUISSE
18	NASTENKO IVAN-UKR-UKRAINE
19	DONKER DONNY-NED-PAYS-BAS
20	-----

13	RIBERE JUL 11 / 3
14	WILLARD MI 50FI / 0
15	NASTENKO I 50FI / 0
16	DONKER DON xxxxx / xxxxx

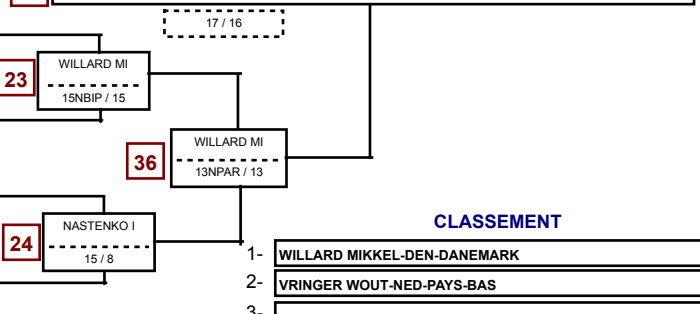

## CLASSEMENT

1-	WILLARD MIKKEL-DEN-DANEMARK
2-	VRINGER WOUT-NED-PAYS-BAS
3-	
3-	
5-	
5-	

nb= 28 - combattants - repêchage intégral

R13	HAYRAPETYAN MURAD-ESP-Espagne
R14	SCHELL Thomas-GER-ALLEMAGNE
R15	EBERLE ROBIN-SWE-SUISSE
R16	CECCHINI DANIELE-ITA-Italie
R9	PEREZ ALEXANDRE-FRA-France
R10	AOUICHI AHMED-TUN-TUNISIE
R11	BALTAYAN HERVE-FRA-France
R12	SETH WENZEL WILLIAM-SWE-SUEDE
R5	DIEVART THOMAS-FRA-France
R6	KARPFINGER PHIL-GER-ALLEMAGNE
R7	BAEZ NICOLAS-SUI-SUISSE
R8	CIRELLI MATTIA-ITA-Italie
R1	MUSSARD MICKAEL-FRA-France
R2	LUCCHESI FABRIZIO-SWE-SUISSE
R3	MARTY LAURENT-FRA-France
R4	DONKER DONNY-NED-PAYS-BAS

25	SCHELL Thomas-GER-ALLEMAGNE
37	SCHELL Thomas-GER-ALLEMAGNE
47	SCHELL Thomas-GER-ALLEMAGNE
38	CECCHINI DANIELE-ITA-Italie
27	PEREZ ALEXANDRE-FRA-France
39	MEJBORN JONAS-DEN-DANEMARK
48	SETH WENZEL WILLIAM-SWE-SUEDE
40	SETH WENZEL WILLIAM-SWE-SUEDE
29	DIEVART THOMAS-FRA-France
41	VASE JAKOB KARGO-DEN-DANEMARK
49	BAEZ NICOLAS-SUI-SUISSE
42	BAEZ NICOLAS-SUI-SUISSE
31	LUCCHESI FABRIZIO-SWE-SUISSE
43	RIBERE JULIEN-FRA-France
32	MARTY LAURENT-FRA-France
44	MARTY LAURENT-FRA-France
50	RIBERE JULIEN-FRA-France
51	SCHELL Thomas-GER-ALLEMAGNE
55	SCHELL Thomas-GER-ALLEMAGNE
52	SETH WENZEL WILLIAM-SWE-SUEDE
57	GRISHCHENKO DIMITRIY-RUS-RUSSIE
45	GRISHCHENKO DIMITRIY-RUS-RUSSIE
53	KRAJEWSKI TOMASZ-POL-POLOGNE
56	RIBERE JULIEN-FRA-France
54	RIBERE JULIEN-FRA-France
58	MEDVEDSKOV MAKSIM-RUS-RUSSIE
54	RIBERE JULIEN-FRA-France
58	MEDVEDSKOV MAKSIM-RUS-RUSSIE

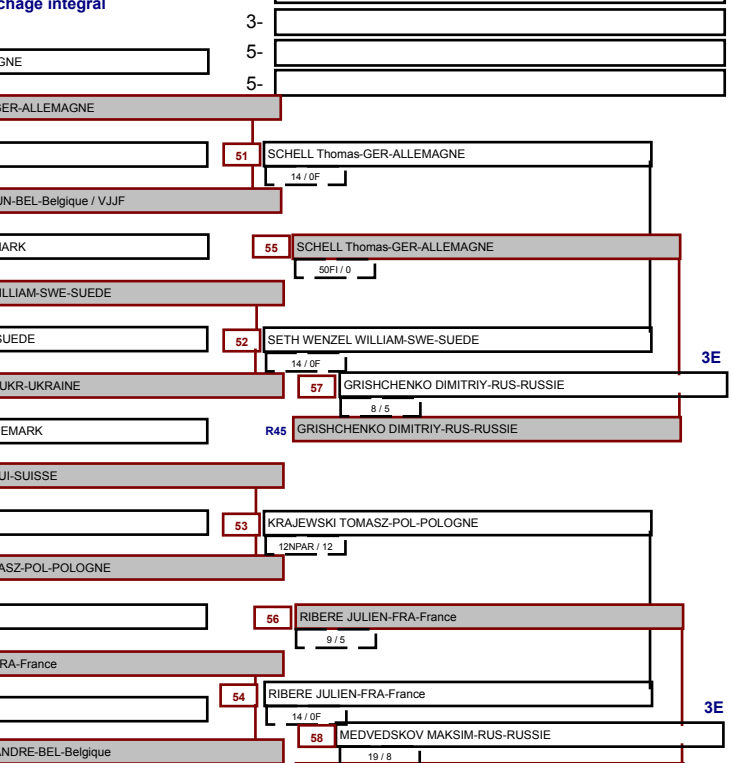

1ER

3E

3E

# PARIS M-94.chp

PARIS 2014

02/05/2014 21:07

KARLSSON LARS-SWE-SUEDE	1
LAH BENJAMIN-SLO-SLOVENIE	2
MARCHENKO DMITRII-RUS-RUSSIE	3
SEJKENS JOEY-NED-PAYS-BAS	4
GOUSSANOU DAVID-FRA-France	5

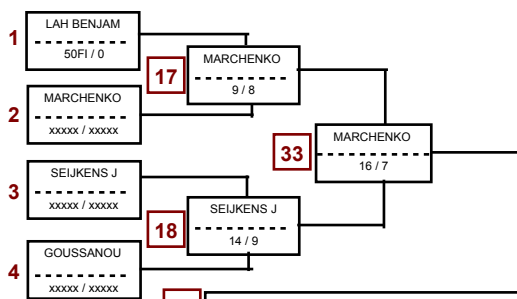

MULLER CHRISTOPHER-GER-ALLEMAGNE	6
MARGARIPOULOS SPIRIDON-GRE-GRECE	7
PETPOV EVGENIY-RUS-RUSSIE	8
SZEWCZAK JACEK-POL-POLOGNE	9
COSTE SEBASTIEN-FRA-France	10

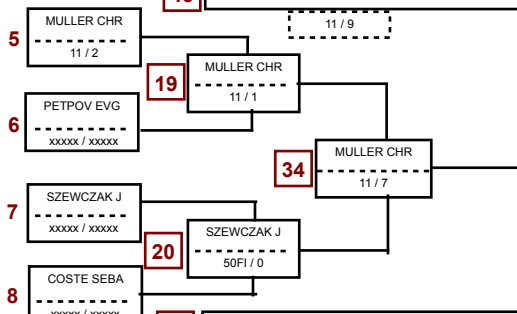

WEIDENBECHER TIM-GER-ALLEMAGNE	11
MARGARIPOULOS DIMITRIOS-GRE-GRECE	12
BELOV DENIS-RUS-RUSSIE	13
SZEWCZAK TOMASZ-POL-POLOGNE	14
MOMCILOVIC ALEXANDRE-FRA-France	15

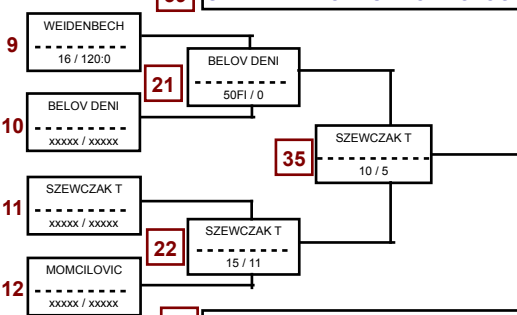

KUIPERS LEROY-NED-PAYS-BAS	17
LEFEVRE MATHIEU-FRA-France	18
CHARKIN ILYA-RUS-RUSSIE	19
VINCENT GEOFFREY-FRA-France	20

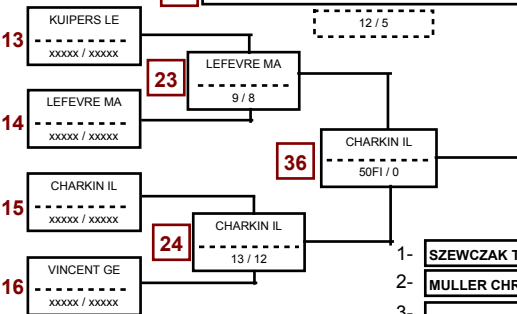

nb= 19 - combattants - repêchage intégral

R13	25	xxxxx/xxxxx	37	xxxxx/xxxxx	LAH BENJAMIN-SLO-SLOVENIE
R14	R17	LAH BENJAMIN-SLO-SLOVENIE	47	50FI/0	LAH BENJAMIN-SLO-SLOVENIE
R15	26	xxxxx/xxxxx	38	xxxxx/xxxxx	GOUSSANOU DAVID-FRA-France
R16	R18	GOUSSANOU DAVID-FRA-France	51	14/0H	LAH BENJAMIN-SLO-SLOVENIE
R9	27	xxxxx/xxxxx	39	14/5	MARGARIPOULOS DIMITRIOS-GRE-GRECE
R10	R19	PETPOV EVGENIY-RUS-RUSSIE	48	18/8	MARGARIPOULOS DIMITRIOS-GRE-GRECE
R11	28	xxxxx/xxxxx	40	xxxxx/xxxxx	COSTE SEBASTIEN-FRA-France
R12	R20	COSTE SEBASTIEN-FRA-France	52	50FI/0	LEFEVRE MATHIEU-FRA-France
R5	29	xxxxx/xxxxx	41	14/120:0	WEIDENBECHER TIM-GER-ALLEMAGNE
R6	R21	WEIDENBECHER TIM-GER-ALLEMAGNE	49	50FI/0	MOMCILOVIC ALEXANDRE-FRA-France
R7	30	xxxxx/xxxxx	42	xxxxx/xxxxx	MOMCILOVIC ALEXANDRE-FRA-France
R8	R22	MOMCILOVIC ALEXANDRE-FRA-France	53	50FI/0	MOMCILOVIC ALEXANDRE-FRA-France
R1	31	xxxxx/xxxxx	43	50FI/0	KUIPERS LEROY-NED-PAYS-BAS
R2	R23	KUIPERS LEROY-NED-PAYS-BAS	50	14/8	VINCENT GEOFFREY-FRA-France
R3	32	xxxxx/xxxxx	44	xxxxx/xxxxx	VINCENT GEOFFREY-FRA-France
R4	R24	VINCENT GEOFFREY-FRA-France	54	18/16	SZEWCZAK JACEK-POL-POLOGNE
				13NPAR/13	MOMCILOVIC ALEXANDRE-FRA-France
					MARCHENKO DMITRII-RUS-RUSSIE

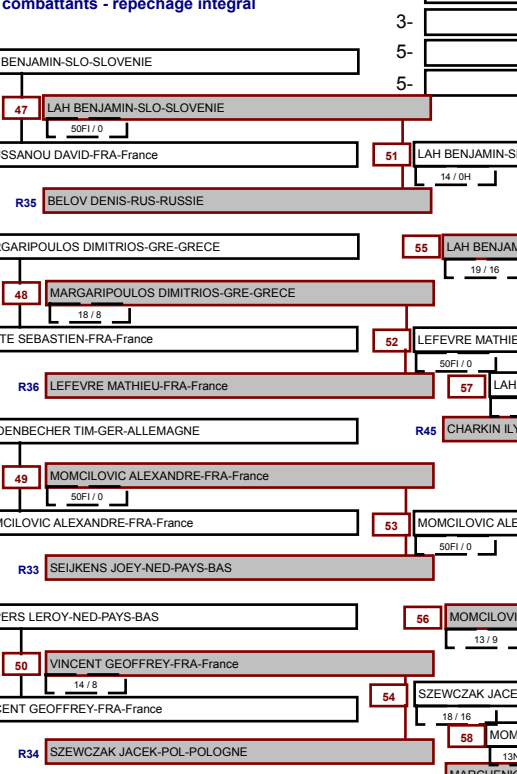

## CLASSEMENT

1-	SZEWCZAK TOMASZ-POL-POLOGNE
2-	MULLER CHRISTOPHER-GER-ALLEMAGNE
3-	
3-	
5-	
5-	

1ER

3E

3E

HOFBAUER NORBERT-AUT-Autriche			
<b>1</b>	50F1 / 0	FROMMANGE ALEXANDRE-FRA-France	
FROMMANGE ALEXANDRE-FRA-France			
		<b>9</b>	50F1 / 0 FROMMANGE ALEXANDRE-FRA-France
MININ ALEKSEI-RUS-RUSSIE			
<b>2</b>	14 / 0F	HERAULT SEBASTIEN-FRA-France	
HERAULT SEBASTIEN-FRA-France			
		<b>21</b>	50 / 0 FROMMANGE ALEXANDRE-FRA-France
MOLLENHAUER Rado-GER-ALLEMAGNE			
<b>3</b>	15 / 30:00	MOLLENHAUER Rado-GER-ALLEMAGNE	
GOFFINET DAMIEN-FRA-France			
		<b>10</b>	50F1 / 0 SMIRNOV MIKHAIL-RUS-RUSSIE
SMIRNOV MIKHAIL-RUS-RUSSIE			
<b>4</b>	50F1 / 0	SMIRNOV MIKHAIL-RUS-RUSSIE	
SAANOUNI MAKREM-TUN-TUNISIE			
		<b>27</b>	14 / 10 FROMMANGE ALEXANDRE-FRA-France
GOMIS GARCIA PEDRO-ESP-Espagne			
<b>5</b>	18 / 3	LEVREL REGIS-FRA-France	
LEVREL REGIS-FRA-France			
		<b>11</b>	50F1 / 0 KUBUROVIC LAZAR-DEN-DANEMARK
BORISKIN SERGEI-RUS-RUSSIE			
<b>6</b>	14 / 0H0:2	KUBUROVIC LAZAR-DEN-DANEMARK	
KUBUROVIC LAZAR-DEN-DANEMARK			
		<b>22</b>	11 / 9 KUBUROVIC LAZAR-DEN-DANEMARK
ROIGER SIMON-GER-ALLEMAGNE			
<b>7</b>	50 / 0	ROIGER SIMON-GER-ALLEMAGNE	
SEIGNEURY GAETAN-FRA-France			
		<b>12</b>	50F1 / 0 ROIGER SIMON-GER-ALLEMAGNE
UDOL EVENS-FRA-France			
<b>8</b>	xxxxx / xxxxxx	UDOL EVENS-FRA-France	
-----			

1ER

nb= 15 - combattants - repêchage intégral

CLASSEMENT

1-	FROMMANGE ALEXANDRE-FRA-France
2-	KUBUROVIC LAZAR-DEN-DANEMARK
3-	SMIRNOV MIKHAIL-RUS-RUSSIE
3-	MOLLENHAUER Rado-GER-ALLEMAGNE
5-	LEVREL REGIS-FRA-France
5-	ROIGER SIMON-GER-ALLEMAGNE

<b>R1</b>	HOFBAUER NORBERT-AUT-Autriche		
<b>R2</b>	<b>13</b>	14 / 0M	HOFBAUER NORBERT-AUT-Autriche
	MININ ALEKSEI-RUS-RUSSIE	<b>17</b>	50 / 0 LEVREL REGIS-FRA-France
	<b>R11</b>		LEVREL REGIS-FRA-France
			<b>23</b>
<b>R3</b>	GOFFINET DAMIEN-FRA-France	50 / 0	LEVREL REGIS-FRA-France
<b>R4</b>	<b>14</b>	50F1 / 0	SAANOUNI MAKREM-TUN-TUNISIE
	SAANOUNI MAKREM-TUN-TUNISIE	<b>18</b>	14 / 0F UDOL EVENS-FRA-France
	<b>R12</b>		UDOL EVENS-FRA-France
			<b>25</b>
		50 / 0	SMIRNOV MIKHAIL-RUS-RUSSIE
			<b>3E</b>
<b>R5</b>	GOMIS GARCIA PEDRO-ESP-Espagne		<b>R21</b>
	GOMIS GARCIA PEDRO-ESP-Espagne		SMIRNOV MIKHAIL-RUS-RUSSIE
<b>R6</b>	<b>15</b>	14 / 0F	GOMIS GARCIA PEDRO-ESP-Espagne
	BORISKIN SERGEI-RUS-RUSSIE	<b>19</b>	12 / 9 HERAULT SEBASTIEN-FRA-France
	<b>R9</b>		HERAULT SEBASTIEN-FRA-France
			<b>24</b>
<b>R7</b>	SEIGNEURY GAETAN-FRA-France	50F1 / 0	MOLLENHAUER Rado-GER-ALLEMAGNE
<b>R8</b>	<b>16</b>	xxxxx / xxxxxx	SEIGNEURY GAETAN-FRA-France
	-----		
		<b>20</b>	50 / 0 MOLLENHAUER Rado-GER-ALLEMAGNE
	<b>R10</b>		MOLLENHAUER Rado-GER-ALLEMAGNE
			<b>26</b>
		8 / 6	MOLLENHAUER Rado-GER-ALLEMAGNE
			<b>3E</b>
			<b>R22</b>
			ROIGER SIMON-GER-ALLEMAGNE