



2010 LONDON BRITISH OPEN

(GBR London, 15-16 May 2010)

-60 kg

24 Judoka

POOL A

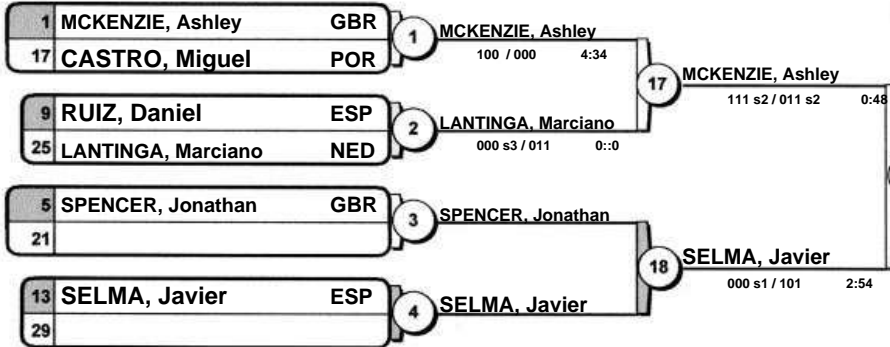

Pool A - Winner
Vainqueur / Sieger

POOL B



Pool B - Winner
Vainqueur / Sieger

POOL C

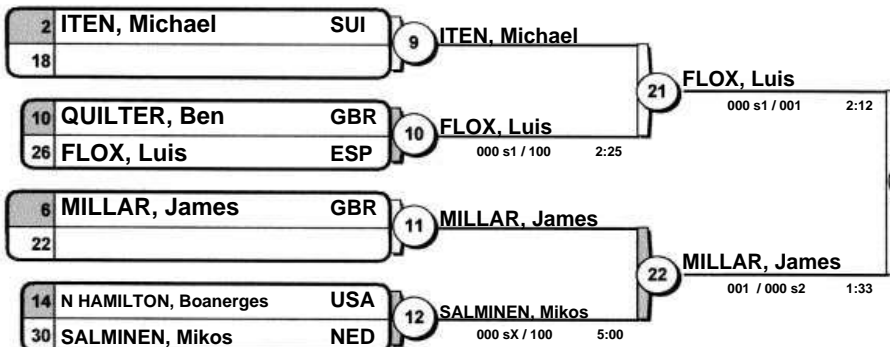

Pool C - Winner
Vainqueur / Sieger

POOL D



Pool D - Winner
Vainqueur / Sieger



1.

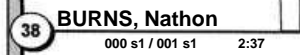

Results	
Résultat / Platzierungen	
1.	MCKENZIE, Ashley GBR
2.	BURNS, Nathon GBR
3.	SELMA, Javier ESP
3.	MILLAR, James GBR
5.	FLOX, Luis ESP
5.	OOMEN, Stef NED
7.	HAUPT, Marcel GER
7.	ABETBOOL, Yakov ISR

Repechage / Trostrunde

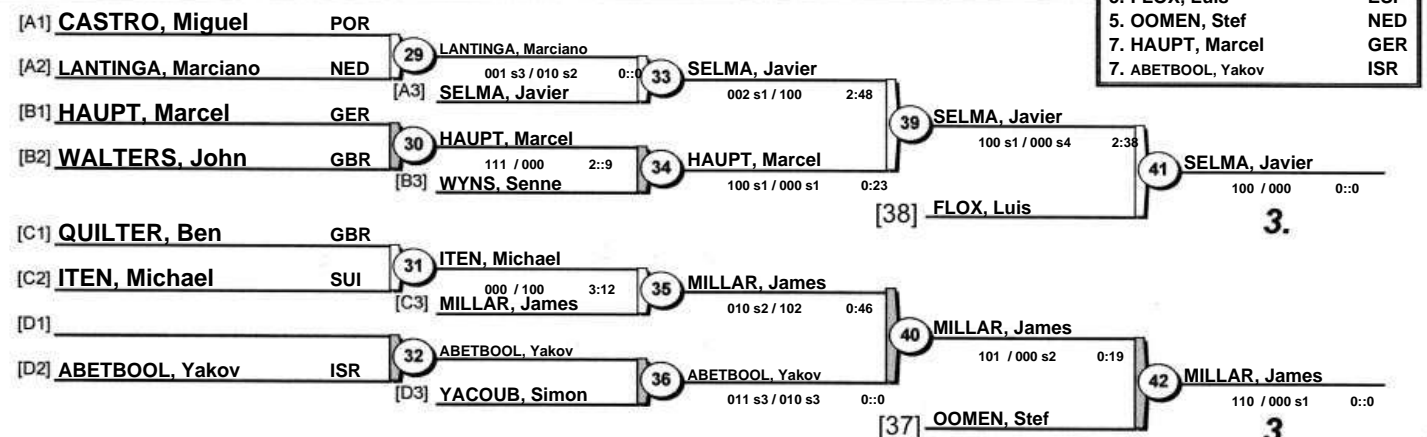

3.

3.



2010 LONDON BRITISH OPEN

(GBR London, 15-16 May 2010)

-66 kg

49 Judoka

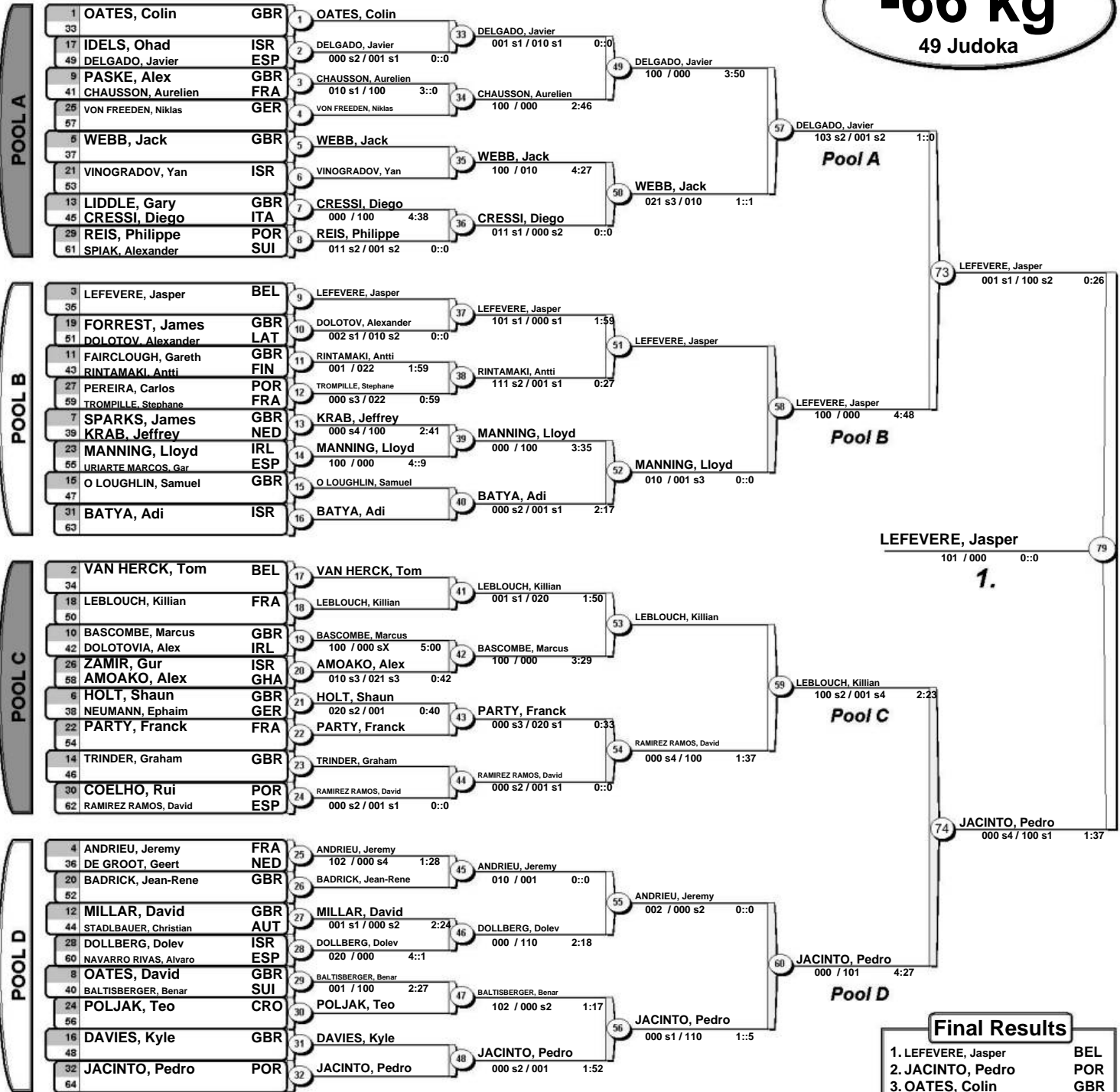

Repechage

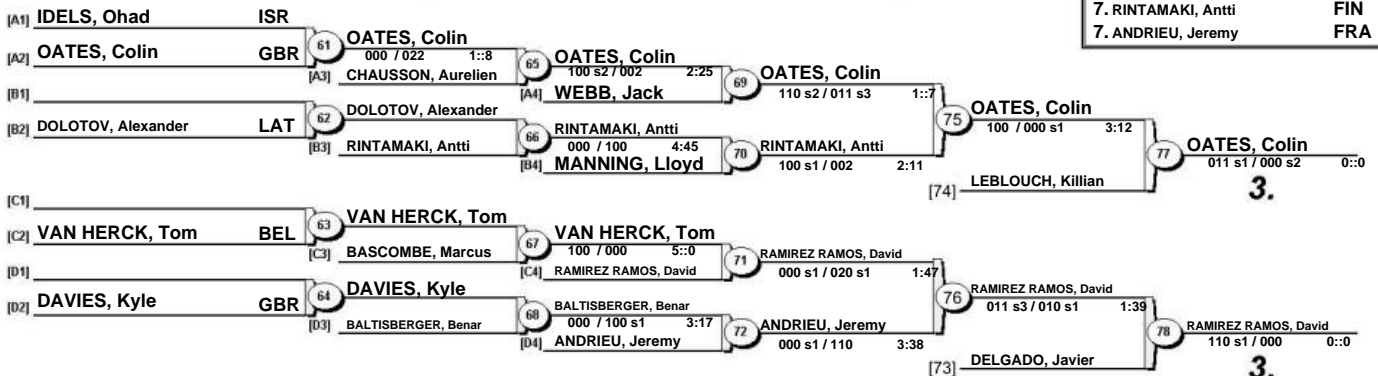



2010 LONDON BRITISH OPEN

(GBR London, 15-16 May 2010)

-73 kg

55 Judoka

POOL A

1	ROMERO AZPITARTE, Miguel	ESP
33	NIETLSPACH, Martin	SUI
17	GONZALEZ CABOT, David	ESP
49	BURAZERIS, Lurie	MDA
9	ASHTON-FARR, Liam	GBR
41	URODA, Tomislav	CRO
25	FERNANDES, Jorge	POR
57	SMIT, Richard	NED
5	PARSONS, Jason	GBR
37	BLANCO RODRIGUEZ, Aaron	ESP
53	BORG, Roch	GBR
13	HERZIG, Johannes	GER
45	COSTA, Daniel	POR
29	BESNARD, Christophe	FRA
61		

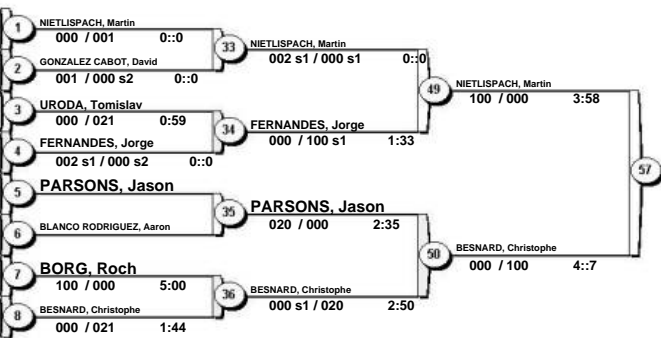

Pool A

POOL B

3	HEIMLICH, Florian	GER
35	NORTAN, Benji	NED
19	ROBINSON-REID, Jerome	GBR
51	DE MOLINER, Raphael	SUI
11	PITTMAN, Billy	GBR
43	SUAREZ IGLESIAS, Javier	ESP
27	HAINE, Kevin	BEL
59	FERREIRA, Ricardo	POR
7	GOSIEWSKI, Jan	GBR
39	NEUMANN, Johannes	GER
23	DAWSON, Patrick	GBR
47	CZUKIEWYCZ, David	FRA
31	NOVOTNY, Manuel	AUT
63		

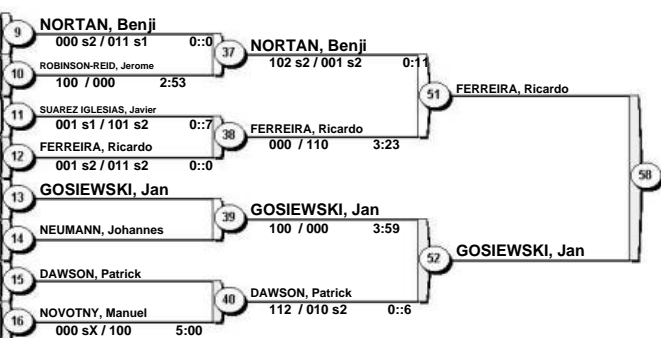

Pool B

POOL C

2	FEENAN, Iain	GBR
34	CRNOV, Dragan	CRO
18	FINNEY, Daniel	GBR
50	V D KAMER, Neal	NED
10	MORRIS, Jonathan	GBR
42	ALVES, Andre	POR
26	LE CAM, Quentin	SUI
6	CHAMBERLAIN, Frazer	GBR
38	SEIDLMEIER, Fabian	GER
22	CARDOSO, Miguel	POR
54	LAAMANEN, Eetu	FIN
14	SHINKIN, Lee	GBR
46	OTT, Marcel	AUT
30	SANCHEZ FERNANDEZ, Antonio	ESP
62		

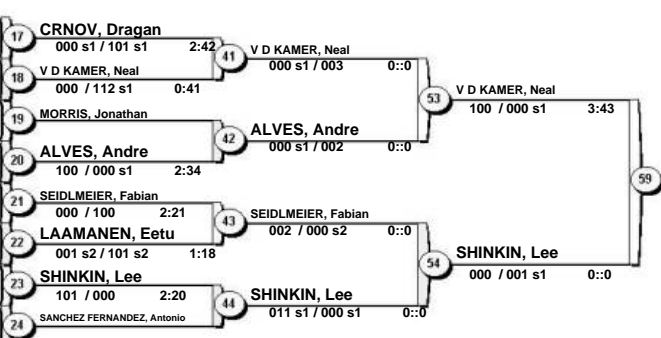

Pool C

POOL D

4	PACO, David	ESP
36	SANCHEZ MONDACA, Diego	ESP
20	VESTE, Andrei	POR
52	CLARKE, Alwyn	GBR
12	CLARKE, Alwyn	GBR
44	SLEECKX, Koen	BEL
28	DRACIUS, Thibaut	FRA
60	HARPER, Danny	GBR
8	VONK, Dennis	NED
40	SANZ PEREZ, Sergio	ESP
24	MELLA, Federico	ITA
56	NARTEY, Emmanuel	GHA
16	MOSER, Markus	AUT
48	WANDTKE, Igor	GER
32	SOMMER, Dominik	SUI
64		

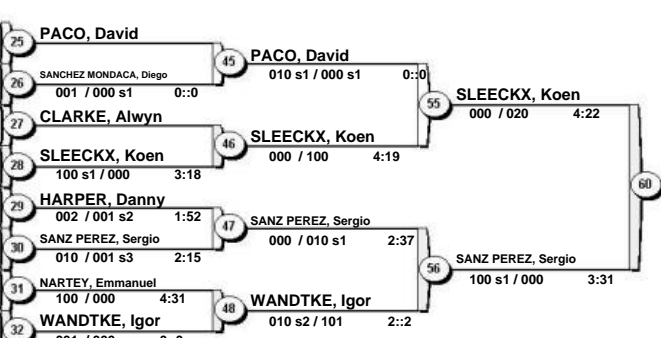

Pool D

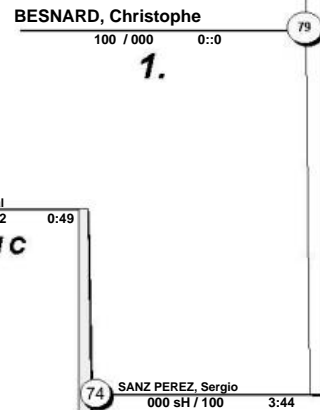

Final Results	
1.	BESNARD, Christophe FRA
2.	SANZ PEREZ, Sergio ESP
3.	V D KAMER, Neal NED
3.	ALVES, Andre POR
5.	NIETLSPACH, Martin SUI
7.	FERREIRA, Ricardo POR
7.	GOSIEWSKI, Jan GBR
7.	SLEECKX, Koen BEL

Repechage





2010 LONDON BRITISH OPEN

(GBR London, 15-16 May 2010)

-81 kg

44 Judoka

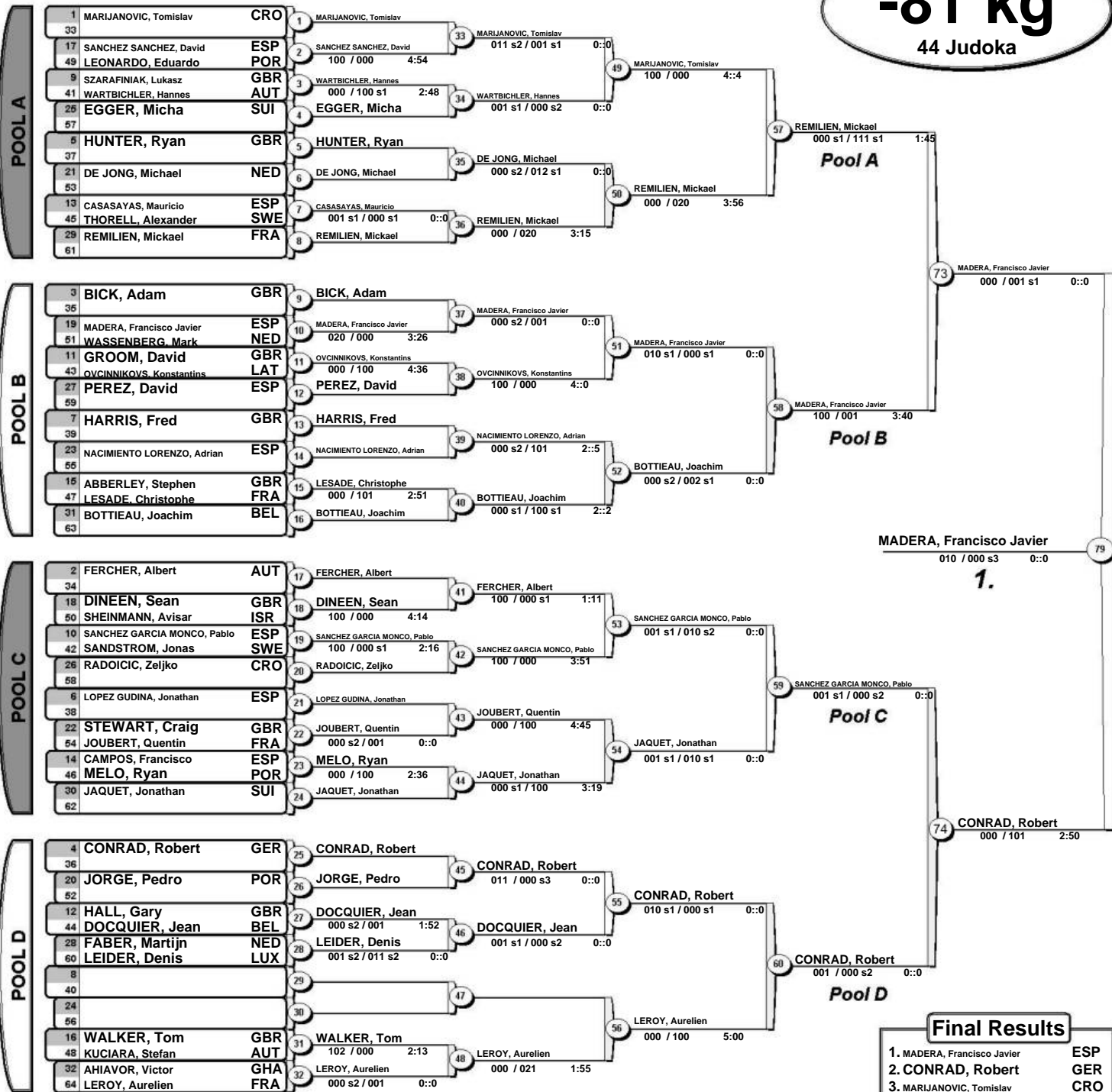

Repechage

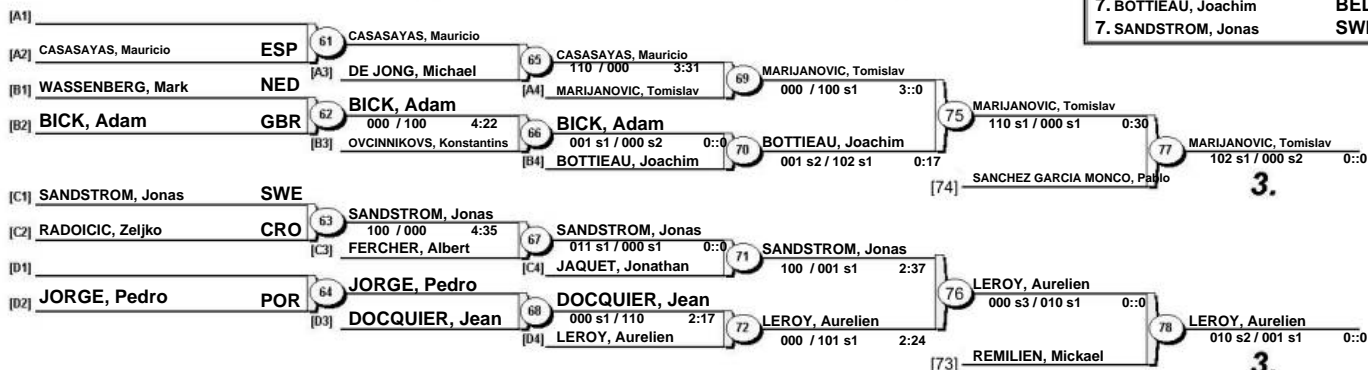



2010 LONDON BRITISH OPEN

(GBR London, 15-16 May 2010)

-90 kg

28 Judoka

POOL A

1	LHOMME, Alexandre	FRA	1	LHOMME, Alexandre	021 / 000 s2	0:51
17	DVARBY, Joakim	SWE	17	BURNS, Andrew	000 s1 / 100	3:43
9	BURNS, Andrew	GBR	2	BURNS, Andrew	111 / 000 s3	0:22
25	VETTER, Hannes	GER	25	BURNS, Andrew	011 s3 / 010 s2	0:00
5	MOORE, Jason	GBR	3	ANEIROS SANCHEZ, Carlos	010 s4 / 100	0:41
21	ANEIROS SANCHEZ, Carlos	ESP	18	HORLEY, Michael	000 s1 / 020	2:43
13	HORLEY, Michael	GBR	4	HORLEY, Michael		
29						

Pool A - Winner
Vainqueur / Sieger

POOL B

3	HASANBEGOVIC, Mirza	BIH	5	HASANBEGOVIC, Mirza	100 s1 / 001	2:12
19	ONETO, Franck	FRA	19	INGRAM, Sam	000 / 101	4:05
11	INGRAM, Sam	GBR	6	INGRAM, Sam		
27						
7	KELLY, Jack	GBR	7	TIKKANEN, Matias	000 s1 / 100	0:02
23	TIKKANEN, Matias	FIN	20	GIELIS, Derek Nathan	000 / 100	4:24
15	MINGUEZ, Andres	ESP	8	GIELIS, Derek Nathan	000 / 100	2:55
31	GIELIS, Derek Nathan	BEL				

Pool B - Winner
Vainqueur / Sieger

POOL C

2	VAN DEN BRINK, Remco	NED	9	VAN DEN BRINK, Remco		
18			21	VAN DEN BRINK, Remco	100 / 000	4:25
10	ZABOLOTNIJ, Ruslan	GBR	10	ZABOLOTNIJ, Ruslan	100 / 000	3:25
26	TAVRA, Ivan	CRO	27	VAN DEN BRINK, Remco	100 / 000 s1	1:33
6	RICH, Bobby	GBR	11	HOVANISIAN, Edvin	000 s2 / 001 s1	0:00
22	HOVANISIAN, Edvin	FRA	22	ARNAL MENGOD, Alberto	000 / 101 s1	2:32
14	CNUUDE, Steven	BEL	12	ARNAL MENGOD, Alberto	010 s3 / 020	1:33
30	ARNAL MENGOD, Alberto	ESP				

Pool C - Winner
Vainqueur / Sieger

POOL D

4	CARRENO LOPEZ, Isaac	ESP	13	CARRENO LOPEZ, Isaac	010 s1 / 000 s3	0:00
20	TAYLOR, Luke	GBR	23	CARRENO LOPEZ, Isaac	020 s3 / 010 s1	0:25
12	BERTOMEU LOPEZ, Jaime	ESP	14	BERTOMEU LOPEZ, Jaime		
28						
8	QUEIRO, Alejandro	ESP	15	HAAS, Christian	000 / 110 s1	1:41
24	HAAS, Christian	AUT	24	GERMROTH, Florian	000 / 110	3:21
16	DALEY, Nicholi	GBR	16	GERMROTH, Florian	000 / 101	2:52
32	GERMROTH, Florian	GER				

Pool D - Winner
Vainqueur / Sieger

GIELIS, Derek Nathan

37 GIELIS, Derek Nathan
002 s3 / 021 s1 0:00

1.

38 GERMROTH, Florian
011 s2 / 111 s2 0:00

Results

Résultat / Platzierungen

1. GIELIS, Derek Nathan BEL
2. GERMROTH, Florian GER
3. VAN DEN BRINK, Remco NED
3. ARNAL MENGOD, Alberto ESP
5. HORLEY, Michael GBR
5. BURNS, Andrew GBR
7. INGRAM, Sam GBR
7. HAAS, Christian AUT

Repechage / Trostrunde

[A1]	VETTER, Hannes	GER	29	LHOMME, Alexandre	001 / 100	3:40	33	HORLEY, Michael	010 s1 / 100	0:25
[A2]	LHOMME, Alexandre	FRA	[A3]	HORLEY, Michael			39	HORLEY, Michael	101 / 000 s2	3:24
[B1]	MINGUEZ, Andres	ESP	30	MINGUEZ, Andres	020 s1 / 010 s3	0:05	34	INGRAM, Sam	000 / 100	4:30
[B2]	TIKKANEN, Matias	FIN	[B3]	INGRAM, Sam			[38]	VAN DEN BRINK, Remco		
[C1]			31	ZABOLOTNIJ, Ruslan			35	ARNAL MENGOD, Alberto	000 / 110	1:24
[C2]	ZABOLOTNIJ, Ruslan	GBR	[C3]	ARNAL MENGOD, Alberto			40	ARNAL MENGOD, Alberto	100 / 000	4:14
[D1]	DALEY, Nicholi	GBR	32	HAAS, Christian	000 / 100	2:30	36	HAAS, Christian	020 / 010 s1	1:27
[D2]	HAAS, Christian	AUT	[D3]	CARRENO LOPEZ, Isaac			[37]	BURNS, Andrew	100 s1 / 000 s1	0:42

3.

3.



2010 LONDON BRITISH OPEN

(GBR London, 15-16 May 2010)

-100 kg

22 Judoka

POOL A

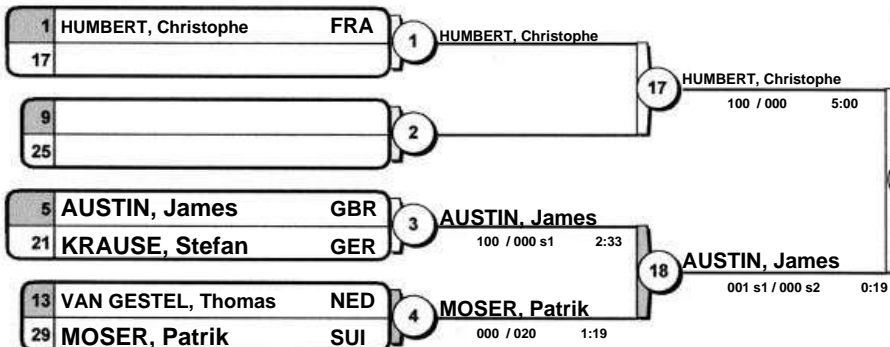

POOL B



POOL C



POOL D

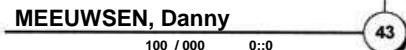
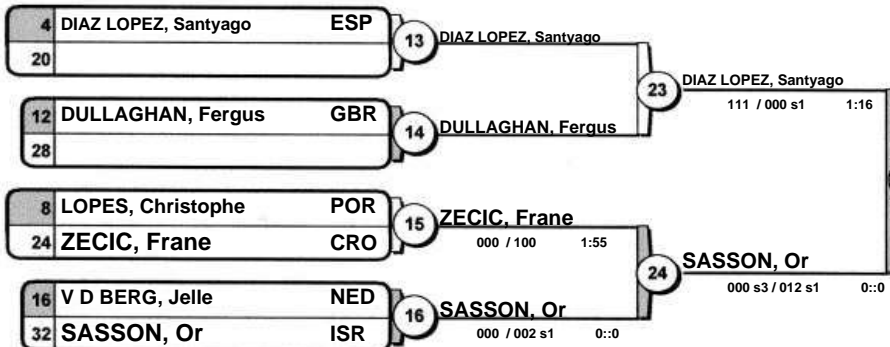

1.

Pool C - Winner
Vainqueur / Sieger

Pool D - Winner
Vainqueur / Sieger

Results
Résultat / Platzierungen

1. MEEUWSEN, Danny NED
2. BINGEN, Brian NED
3. DIAZ LOPEZ, Santiago ESP
3. SASSON, Or ISR
5. MOSER, Patrik SUI
5. AUSTIN, James GBR
7. LEININGER, Jonathan FRA
7. ROLLWAGE, Max GER

Repechage / Trostrunde

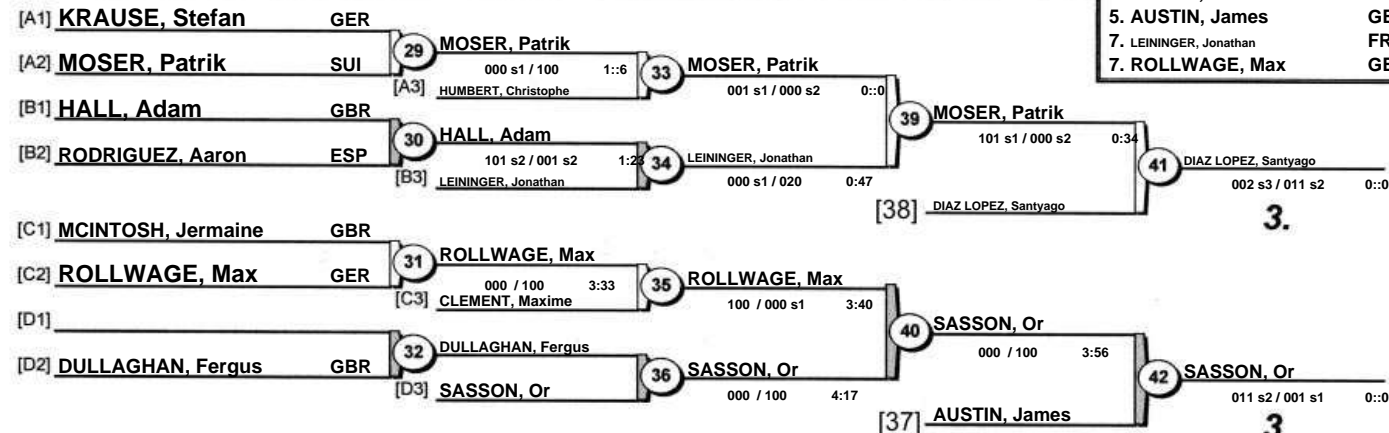

3.

3.



2010 LONDON BRITISH OPEN

(GBR London, 15-16 May 2010)

+100 kg

16 Judoka

POOL A

1	TSIKLAURI, Zviad	GBR	1	VAN LEEUWAARDE, Benjamin	002 s2 / 011 s2	0:0
9	VAN LEEUWAARDE, Benjamin	NED				
5	ALFAJARE, Youcef	GBR	2	BADEDA, Henry	000 / 100	4:11
13	BADEDA, Henry	GER				

9 VAN LEEUWAARDE, Benjamin
100 / 000 4:12
Pool A - Winner
Vainqueur / Sieger

POOL B

3	TRIPALO, Bosko	CRO	3	TRIPALO, Bosko	101 s1 / 001	0:6
11	HAAPA-AHO, Heikki	FIN				
7	SCHOFIELD, Neil	GBR	4	PARRA, Angel	000 / 100	4:36
15	PARRA, Angel	ESP				

10 PARRA, Angel
000 / 101 3:1
Pool B - Winner
Vainqueur / Sieger

POOL C

2	WUSTNER, Jerome	FRA	5	WUSTNER, Jerome	020 / 000 s3	1:59
10	TURNER, Thomas	GBR				
6	CANSECO FERNANDEZ, Victor	ESP	6	CANSECO FERNANDEZ, Victor	021 / 000 s1	2:36
14	SORIANO DE OJAS, Oeste	ESP				

11 WUSTNER, Jerome
011 s1 / 000 s1 0:0
Pool C - Winner
Vainqueur / Sieger

POOL D

4	SHERRINGTON, Chris	GBR	7	SHERRINGTON, Chris	101 / 010	1:17
12	PAHNKE, Tobias	GER				
8	ELLIS, John	GBR	8	ELLIS, John	100 / 010	2:48
16	RISCO DE LA TORRE, Eric	AND				

12 SHERRINGTON, Chris
100 s1 / 010 s1 3:27
Pool D - Winner
Vainqueur / Sieger

PARRA, Angel

100 s1 / 000 s4 0:0

1.

18 WUSTNER, Jerome

011 s1 / 000 s3 0:0

Results

Résultat / Platzierungen

1.	PARRA, Angel	ESP
2.	WUSTNER, Jerome	FRA
3.	SHERRINGTON, Chris	GBR
3.	VAN LEEUWAARDE, Benjamin	NED
5.	TSIKLAURI, Zviad	GBR
5.	PAHNKE, Tobias	GER
7.	TRIPALO, Bosko	CRO
7.	CANSECO FERNANDEZ, Victor	ESP

Repechage / Trostrunde

[A1]	TSIKLAURI, Zviad	GBR	13	TSIKLAURI, Zviad	100 / 000	4:49
[A2]	BADEDA, Henry	GER				
[B1]	SCHOFIELD, Neil	GBR	14	TRIPALO, Bosko	000 / 020	3:29
[B2]	TRIPALO, Bosko	CRO				
[C1]	TURNER, Thomas	GBR	15	CANSECO FERNANDEZ, Victor	000 / 100	3:52
[C2]	CANSECO FERNANDEZ, Victor	ESP				
[D1]	PAHNKE, Tobias	GER	16	PAHNKE, Tobias	110 / 000	3:47
[D2]	ELLIS, John	GBR				

19 TSIKLAURI, Zviad
112 s1 / 000 s2 1:42

[18] SHERRINGTON, Chris

21 SHERRINGTON, Chris
010 s1 / 011 s3 2:0

3.

20 PAHNKE, Tobias
000 / 020 3:9

[17] VAN LEEUWAARDE, Benjamin

22 VAN LEEUWAARDE, Benjamin
001 / 100 s1 0:0

3.



2010 LONDON BRITISH OPEN

(GBR London, 15-16 May 2010)

-48 kg

15 Judoka

POOL A

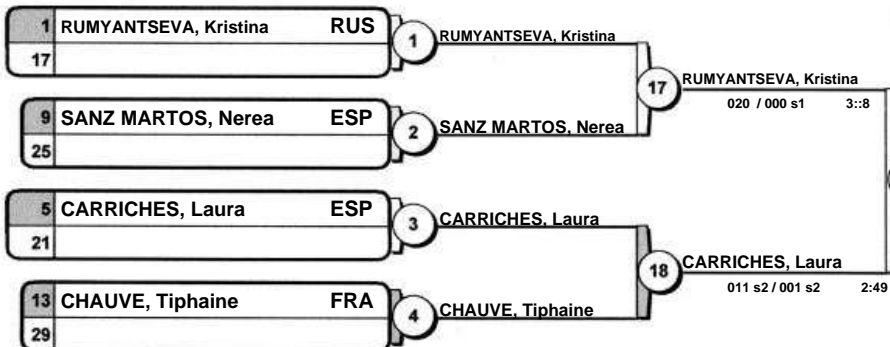

POOL B

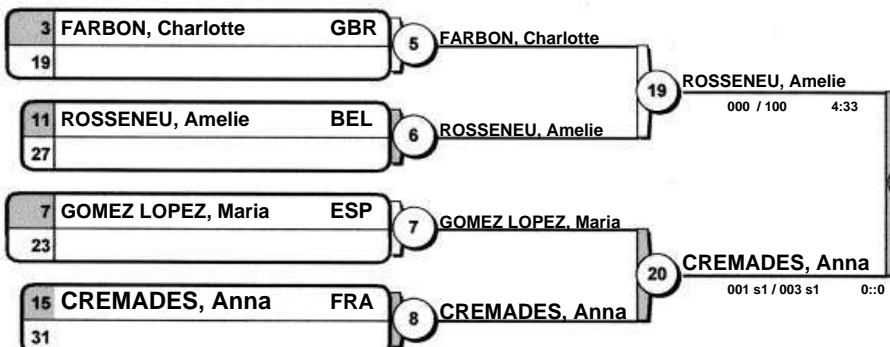

POOL C



POOL D

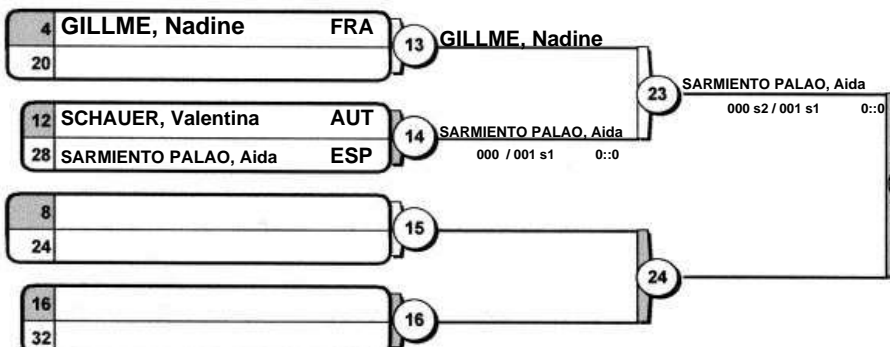

1.



Results	
Résultat / Platzierungen	
1.	ROSSENEU, Amelie BEL
2.	SARMIENTO PALAO, Aida ESP
3.	GARCIA, Vanesa ESP
5.	CREMADES, Anna FRA
7.	GOLLER, Sabine GER
7.	SANZ MARTOS, Nerea ESP
7.	SCHAUER, Valentina AUT

Repechage / Trostrunde

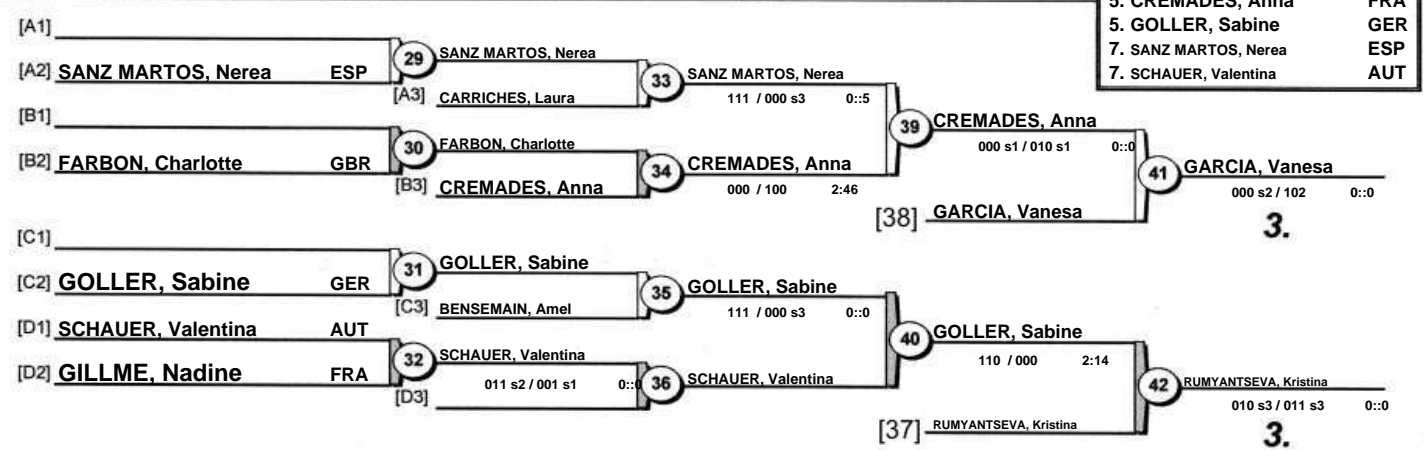

3.

3.



2010 LONDON BRITISH OPEN

(GBR London, 15-16 May 2010)

-52 kg

20 Judoka

POOL A

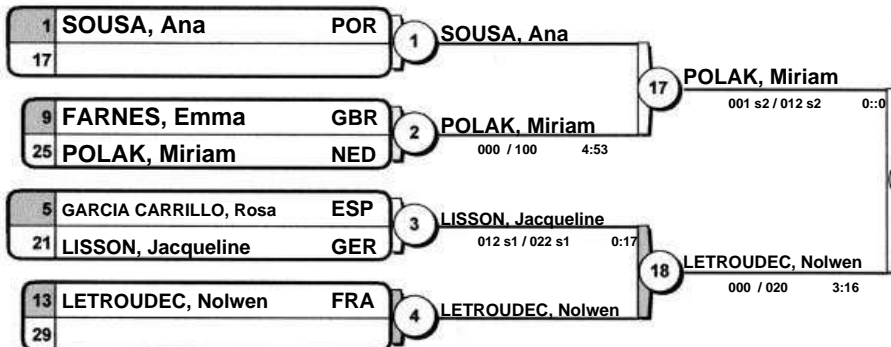

Pool A - Winner
Vainqueur / Sieger

POOL B



Pool B - Winner
Vainqueur / Sieger

POOL C

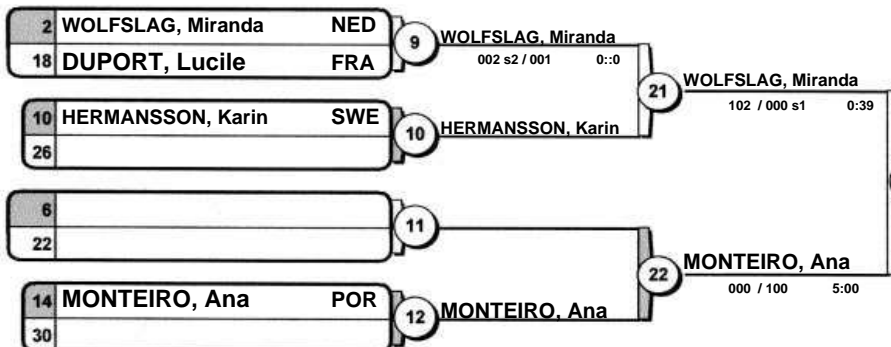

Pool C - Winner
Vainqueur / Sieger

POOL D

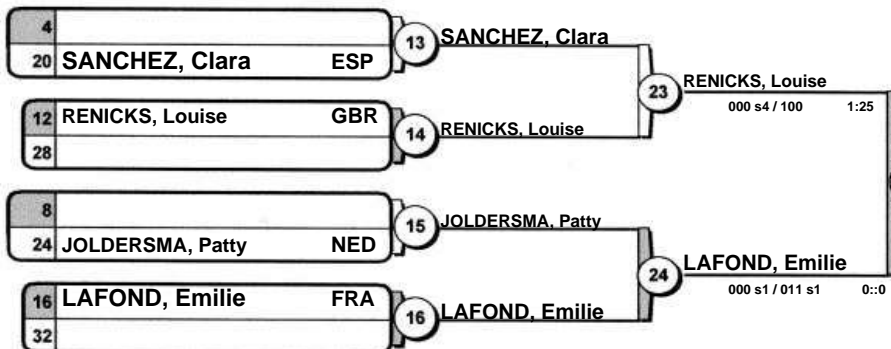

Pool D - Winner
Vainqueur / Sieger

POLAK, Miriam (43)

1.

MONTEIRO, Ana (38) 010 / 000 0:00

Results

Résultat / Platzierungen

- 1. POLAK, Miriam NED
- 2. MONTEIRO, Ana POR
- 3. LAFOND, Emilie FRA
- 3. O NEILL, Siobhan GBR
- 5. SOUSA, Ana POR
- 5. WOLFSLAG, Miranda NED
- 7. RENICKS, Kimberley GBR
- 7. JOLDERSMA, Patty NED

Repechage / Trostrunde

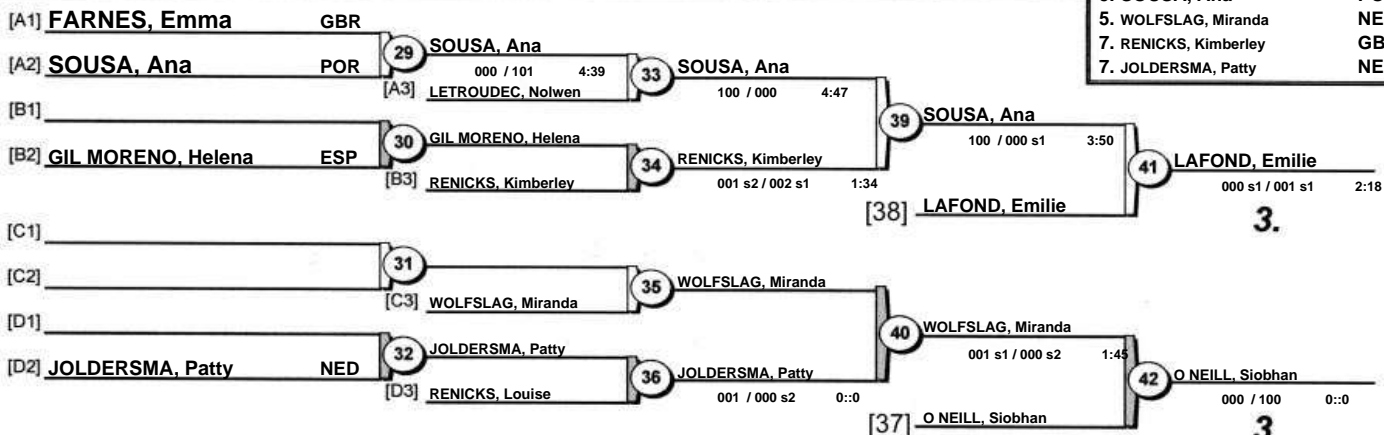

3.

3.



2010 LONDON BRITISH OPEN

(GBR London, 15-16 May 2010)

-57 kg

32 Judoka

POOL A

1	LIBOSAN, Dani	NED	1	LIBOSAN, Dani	100 / 000	5:00
17	GARCIA BONILLA, Carmen	ESP				
9	WOODRUFF, Amy	GBR	2	AMARON, Emilie	000 s1 / 002 s1	0:00
25	AMARON, Emilie	SUI				
5	INGLIS, Stacey	GBR	3	MULLER, Johanna	000 / 020	3:14
21	MULLER, Johanna	GER				
13	ELLRICH, Rebecca	GBR	4	BRUNET, Morgane	000 s3 / 110	2:48
29	BRUNET, Morgane	FRA				

Pool A - Winner
Vainqueur / Sieger

POOL B

3	ANDREASON, Jennie	SWE	5	ANDREASON, Jennie	100 / 000	0:38
19	STANKEVICH, Zhanna	RUS				
11	MINARDI, Nadia	GBR	6	MINARDI, Nadia	110 s1 / 000 s1	2:18
27	LOEFFEL, Gisela	SUI				
7	HAYWOOD, Nicola	GBR	7	BARTEAU, Soisic	000 s2 / 101	1:13
23	BARTEAU, Soisic	FRA				
15	DUNNING, Becky	GBR	8	GROEFSEMA, Maureen	000 sH / 101 s1	2:4
31	GROEFSEMA, Maureen	NED				

Pool B - Winner
Vainqueur / Sieger

POOL C

2	GARMATTER, Miriam	GER	9	GARMATTER, Miriam	100 / 000 s1	4:17
18	PIERCE, Rebecca	GBR				
10	HARRISON, Claire	GBR	10	VERHAGEN, Linsey	000 s1 / 021	2:8
26	VERHAGEN, Linsey	NED				
6	JOHNSON, Janine	GBR	11	ERLEBACH, Eva	000 s1 / 020 s1	1:13
22	ERLEBACH, Eva	SUI				
14	PEACOCK, Sophie	GBR	12	LANDALUCE, Miriam	000 / 020	1:59
30	LANDALUCE, Miriam	ESP				

Pool C - Winner
Vainqueur / Sieger

POOL D

4	VAN BOSSELE, Hanne	BEL	13	VAN BOSSELE, Hanne	100 / 000	2:19
20	FELSKE, Sina	GER				
12	RAMSAY, Connie	GBR	14	RICHARDSON, Shareen	000 s2 / 002	0:00
28	RICHARDSON, Shareen	NED				
8	FEENAN, Kristene	GBR	15	LARRAYA, Nieva	000 s2 / 001	0:00
24	LARRAYA, Nieva	ESP				
16	BAUDIN, Emmanuelle	FRA	16	CESARIO, Joana	000 s1 / 100 s1	1:21
32	CESARIO, Joana	POR				

Pool D - Winner
Vainqueur / Sieger

RICHARDSON, Shareen
000 / 100 0:00

1.

RICHARDSON, Shareen
000 / 101 4:14

38

Results
Résultat / Platzierungen

1. RICHARDSON, Shareen NED
2. ANDREASON, Jennie SWE
3. GARMATTER, Miriam GER
3. MULLER, Johanna GER
5. STANKEVICH, Zhanna RUS
7. LIBOSAN, Dani NED
7. VERHAGEN, Linsey NED

Repechage / Trostrunde

[A1]	INGLIS, Stacey	GBR	29	BRUNET, Morgane	000 / 100	4:34	33	LIBOSAN, Dani	010 s2 / 011 s3	0:00
[A2]	BRUNET, Morgane	FRA								
[B1]	STANKEVICH, Zhanna	RUS	30	STANKEVICH, Zhanna	100 s1 / 000 s1	0:10	34	STANKEVICH, Zhanna	101 / 000 s1	2:32
[B2]	MINARDI, Nadia	GBR								
[C1]	PIERCE, Rebecca	GBR	31	VERHAGEN, Linsey	000 / 100	0:00	35	VERHAGEN, Linsey	001 s1 / 000	0:00
[C2]	VERHAGEN, Linsey	NED								
[D1]	RAMSAY, Connie	GBR	32	RAMSAY, Connie	110 s1 / 000	0:35	36	RAMSAY, Connie	001 / 000 s2	1:39
[D2]	VAN BOSSELE, Hanne	BEL								
[D3]										

3.

3.



2010 LONDON BRITISH OPEN

(GBR London, 15-16 May 2010)

-63 kg

27 Judoka

POOL A

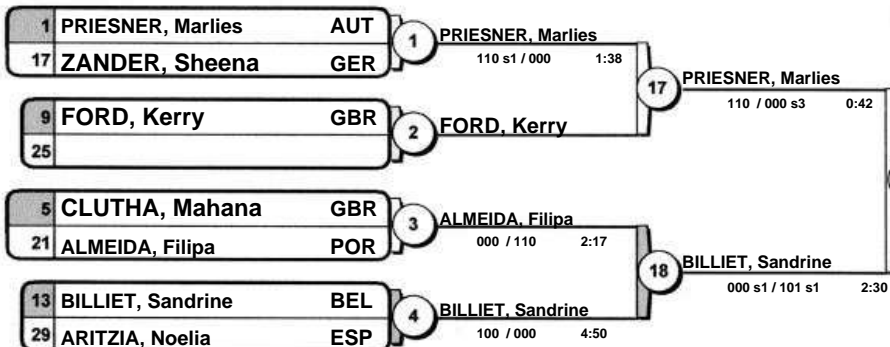

Pool A - Winner
Vainqueur / Sieger

POOL B

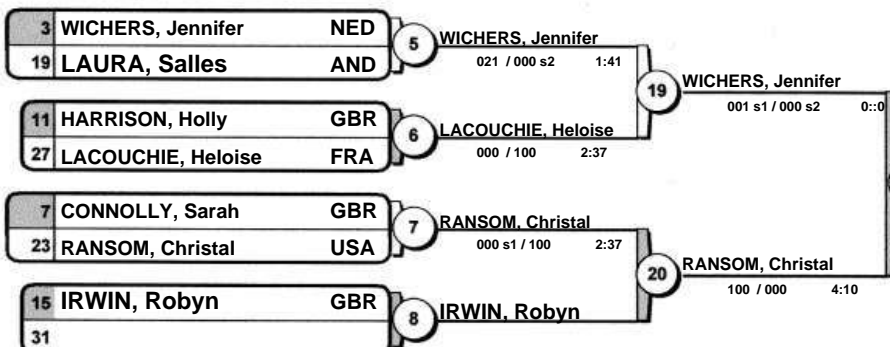

Pool B - Winner
Vainqueur / Sieger

POOL C

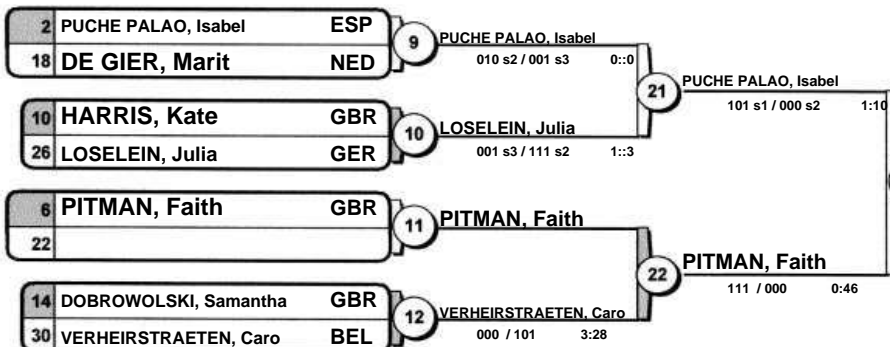

Pool C - Winner
Vainqueur / Sieger

POOL D

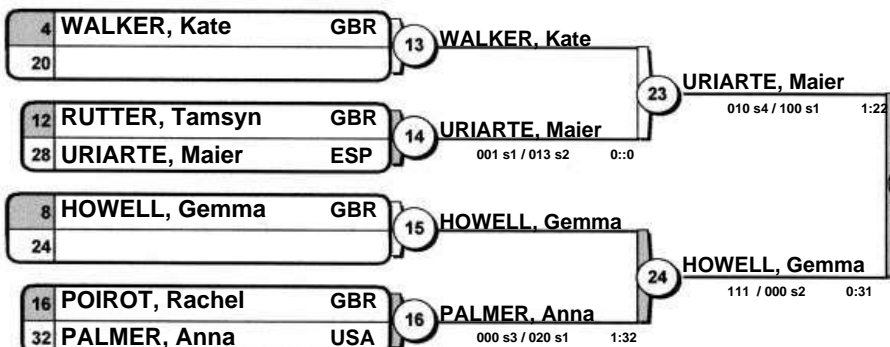

Pool D - Winner
Vainqueur / Sieger

HOWELL, Gemma
000 s1 / 001 0:00

1.

HOWELL, Gemma
001 s3 / 010 0:00

Results		
Résultat / Platzierungen		
1.	HOWELL, Gemma	GBR
2.	WICHERS, Jennifer	NED
3.	LACOUCHIE, Heloise	FRA
3.	PRIESNER, Marlies	AUT
5.	PITMAN, Faith	GBR
5.	PUCHE PALAO, Isabel	ESP
7.	ZANDER, Sheena	GER
7.	URIARTE, Maier	ESP

Repechage / Trostrunde

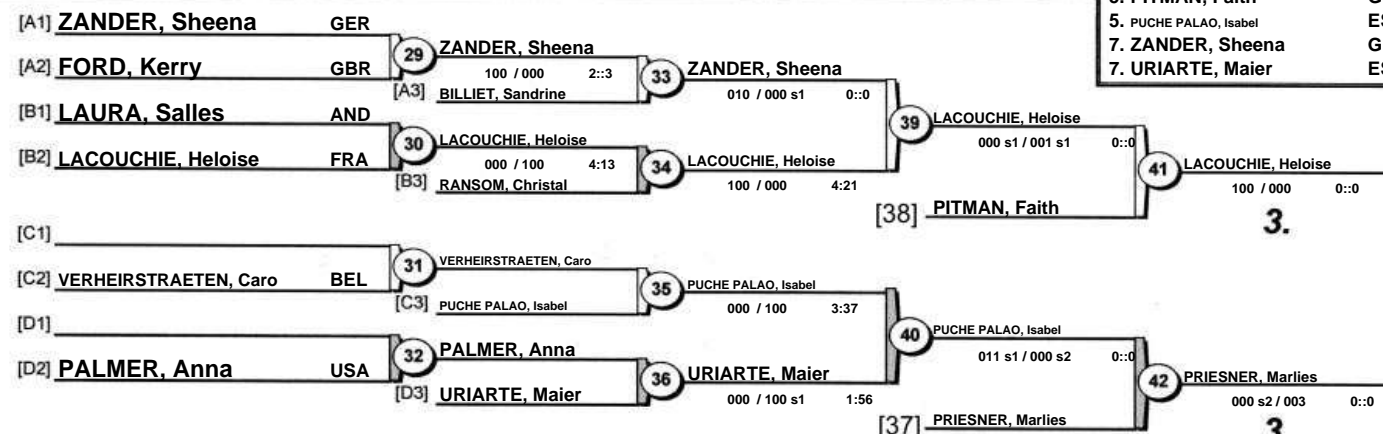

3.

3.



2010 LONDON BRITISH OPEN

(GBR London, 15-16 May 2010)

-70 kg

25 Judoka

POOL A

1	CONWAY, Sally	GBR	1	GERBER, Melanie	000 / 100	2:37
17	GERBER, Melanie	GER	17	GERBER, Melanie	001 s1 / 000	0:0
9	PERROTTE, Lucile	FRA	2	PERROTTE, Lucile	100 s1 / 000	3:35
25	KARLSSON, Frida	SWE	2	PERROTTE, Lucile	010 s2 / 001 s3	0:0
5	GABRIEL, Desiree	SUI	3	GABRIEL, Desiree	000 s3 / 020	0:57
21			3	GABRIEL, Desiree	000 s3 / 020	0:57
13	BERNABEU AVOMO, Maria	ESP	4	BERNABEU AVOMO, Maria		
29			4	BERNABEU AVOMO, Maria		

Pool A - Winner
Vainqueur / Sieger

POOL B

3	BERGER, Karine	FRA	5	BERGER, Karine	101 / 000	1:41
19	ARCQ, Jennifer	BEL	5	BERGER, Karine	010 / 001	0:0
11	BOERS, Linda	NED	6	BOERS, Linda	100 / 000 s1	3:37
27	LUXFORD, Emma	GBR	6	BOERS, Linda	100 / 001	2:16
7	GARRY, Christelle	FRA	7	LISEWSKI, Anne Katrin	001 / 011	0:0
23	LISEWSKI, Anne Katrin	GER	7	LISEWSKI, Anne Katrin	100 / 001	2:16
15	LECHENAUER, Hedwig	AUT	8	LECHENAUER, Hedwig		
31			8	LECHENAUER, Hedwig		

Pool B - Winner
Vainqueur / Sieger

POOL C

2	FLETCHER, Megan	GBR	9	FLETCHER, Megan	100 / 000 s1	2:10
18			9	FLETCHER, Megan	100 / 000	0:23
10	PINET, Amelie	FRA	10	PINET, Amelie	101 / 000	3:25
26	BLEIER, Samantha	USA	10	PINET, Amelie	000 s1 / 100	2:36
6	SUTHERLAND, Fiona	GBR	11	EISNER, Maite	000 s1 / 012 s1	0:0
22	EISNER, Maite	SUI	11	EISNER, Maite	000 s1 / 100	2:36
14	SORDIYA, Irina	RUS	12	SORDIYA, Irina		
30			12	SORDIYA, Irina		

Pool C - Winner
Vainqueur / Sieger

POOL D

4	DIEBOLT, Veronique	FRA	13	DIEBOLT, Veronique	100 / 000 s1	1:14
20	MOSSONG, Lynn	LUX	13	DIEBOLT, Veronique	001 s1 / 000 s1	0:0
12	KUCZNIERZ, Frauke	GER	14	KUCZNIERZ, Frauke	000 / 101	3:25
28			14	KUCZNIERZ, Frauke	100 / 000	4:30
8	ETIENNE, Valeriane	FRA	15	ETIENNE, Valeriane		
24			15	ETIENNE, Valeriane		
16	PEETERS, Zoe	BEL	16	GIBBONS, Gemma	000 s4 / 100	2:26
32	GIBBONS, Gemma	GBR	16	GIBBONS, Gemma		

Pool D - Winner
Vainqueur / Sieger

BERGER, Karine

37 BERGER, Karine

001 s2 / 002 s2 0:0

1.

38 ETIENNE, Valeriane

000 / 020 2:26

Results
Résultat / Platzierungen

1.	BERGER, Karine	FRA
2.	ETIENNE, Valeriane	FRA
3.	CONWAY, Sally	GBR
3.	PINET, Amelie	FRA
5.	FLETCHER, Megan	GBR
5.	GERBER, Melanie	GER
7.	BOERS, Linda	NED
7.	GIBBONS, Gemma	GBR

Repechage / Trostrunde

[A1]	CONWAY, Sally	GBR	29	CONWAY, Sally	100 / 000	3:46
[A2]	PERROTTE, Lucile	FRA	29	CONWAY, Sally	001 s1 / 000 s2	1:39
[B1]	ARCQ, Jennifer	BEL	[A3]	BERNABEU AVOMO, Maria	001 s1 / 000 s2	1:39
[B2]	BOERS, Linda	NED	30	BOERS, Linda	000 / 100	4:22
[C1]			[B3]	LISEWSKI, Anne Katrin	100 / 000 sH	1:22
[C2]	PINET, Amelie	FRA	31	PINET, Amelie	011 s1 / 000 s3	0:0
[D1]			[C3]	SORDIYA, Irina	011 s1 / 000 s3	0:0
[D2]	GIBBONS, Gemma	GBR	32	GIBBONS, Gemma	101 s2 / 002 s2	1:26
			[D3]	DIEBOLT, Veronique	100 / 000	4:59

3.

3.



2010 LONDON BRITISH OPEN

(GBR London, 15-16 May 2010)

-78 kg

21 Judoka

POOL A

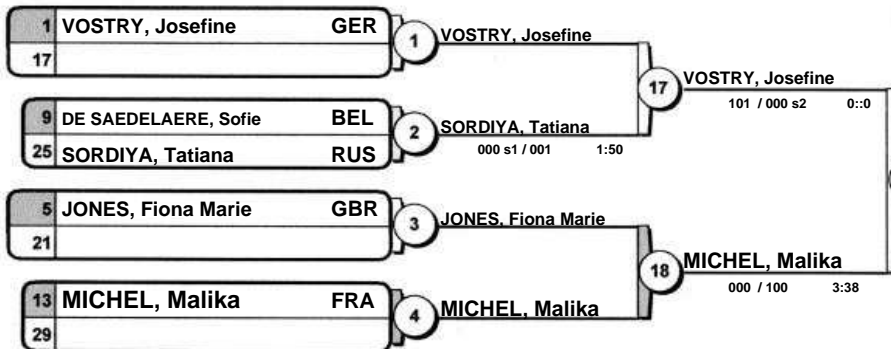

POOL B



POOL C

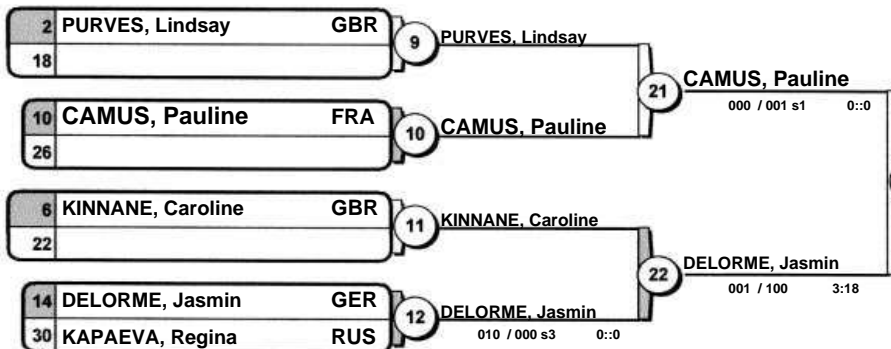

POOL D

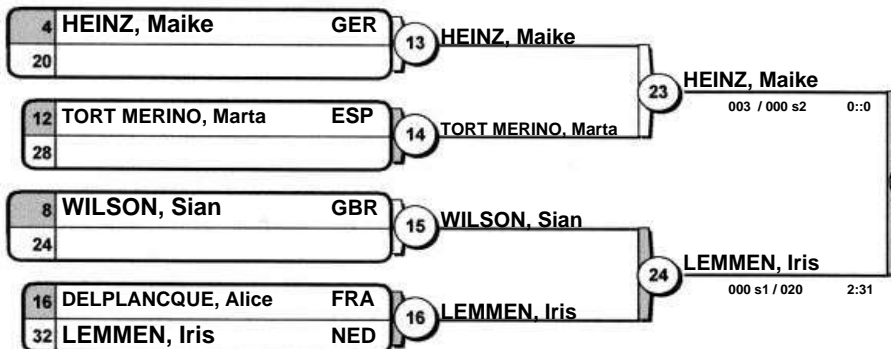

THOREL, Audrey 43

1.

38 LEMMEN, Iris 001/100 0:52

28 LEMMEN, Iris 000 s1/010 0:0

Pool D - Winner Vainqueur / Sieger

Results
Résultat / Platzierungen

1. THOREL, Audrey FRA
2. LEMMEN, Iris NED
3. VAN DIJK, Karin NED
4. VOSTRY, Josefina GER
5. DELORME, Jasmin GER
6. CAMUS, Pauline FRA
7. SORDIYA, Tatiana RUS
8. HEINZ, Maike GER

Repechage / Trostrunde

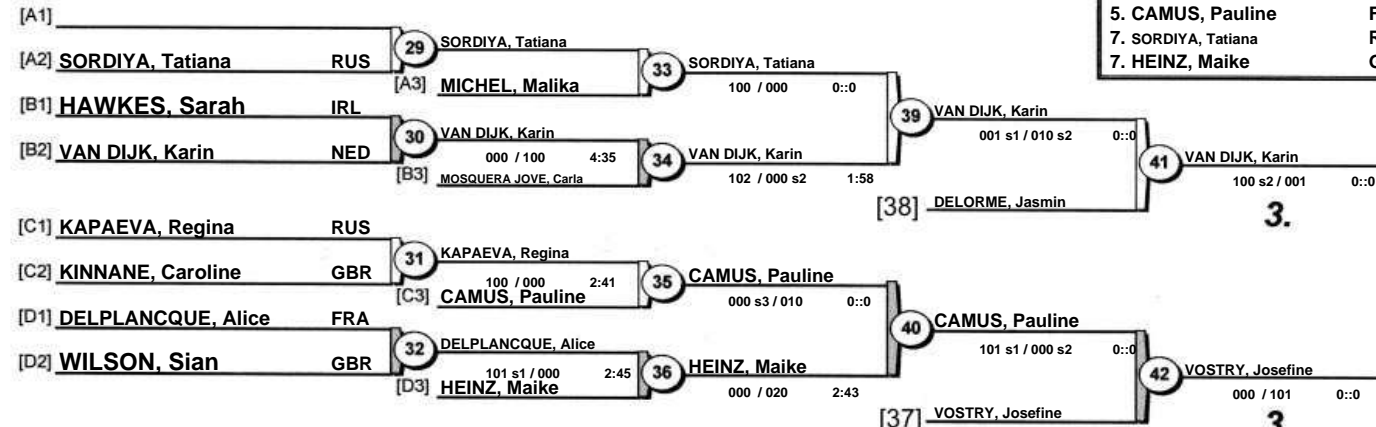

3.

3.



2010 LONDON BRITISH OPEN

(GBR London, 15-16 May 2010)

+78 kg

9 Judoka

POOL A

1 ADLINGTON, Sarah GBR
9

1 ADLINGTON, Sarah
2 GUBADOVA, Anastasia

5 GUBADOVA, Anastasia RUS
13

9 ADLINGTON, Sarah
100 / 000 5:00
Pool A - Winner
Vainqueur / Sieger

POOL B

3 SHEREMETOVA, Ekaterina RUS
11

3 SHEREMETOVA, Ekaterina
4 KUPERS, Gerdien

7 KUPERS, Gerdien NED
15 GASCH, Melanie GER

10 KUPERS, Gerdien
000 / 001 0::0
Pool B - Winner
Vainqueur / Sieger

POOL C

2 ALONSO, Alicia ESP
10

5 ALONSO, Alicia
6 CHIBISOVA, Ksenia

6 CHIBISOVA, Ksenia RUS
14

11 ALONSO, Alicia
101 s1 / 000 1:18
Pool C - Winner
Vainqueur / Sieger

POOL D

4 KARPOVA, Daria RUS
12

7 KARPOVA, Daria
8 JACKSON, Shelley

8 JACKSON, Shelley GBR
16

12 KARPOVA, Daria
100 / 000 4:26
Pool D - Winner
Vainqueur / Sieger

ADLINGTON, Sarah
100 s1 / 000 s1 0::0

17 ADLINGTON, Sarah
111 / 000 sH 1:15
23
1.
18 ALONSO, Alicia
102 / 000 s2 0::2

Results	
Résultat / Platzierungen	
1.	ADLINGTON, Sarah GBR
2.	ALONSO, Alicia ESP
3.	GASCH, Melanie GER
3.	CHIBISOVA, Ksenia RUS
5.	KARPOVA, Daria RUS
5.	KUPERS, Gerdien NED
7.	GUBADOVA, Anastasia RUS
7.	JACKSON, Shelley GBR

Repechage / Trostrunde

[A1] _____

13 GUBADOVA, Anastasia

[A2] GUBADOVA, Anastasia RUS

19 GASCH, Melanie

[B1] GASCH, Melanie GER

14 GASCH, Melanie
101 s1 / 000 s1 1:56

[B2] SHEREMETOVA, Ekaterina RUS

[18] KARPOVA, Daria

21 GASCH, Melanie
100 / 000 0::0
3.

[C1] _____

15 CHIBISOVA, Ksenia

[C2] CHIBISOVA, Ksenia RUS

20 CHIBISOVA, Ksenia
100 / 000 4:53

[D1] _____

16 JACKSON, Shelley

[D2] JACKSON, Shelley GBR

[17] KUPERS, Gerdien

22 CHIBISOVA, Ksenia
100 / 000 s1 0::0
3.