



# Fuengirola Cadet European Cup 2023

Spain, Fuengirola, 18-19 Feb 2023

**-50 kg**  
Cadets (25)

**POOL A**

|  |                         |     |
|--|-------------------------|-----|
|  | CHATTI Amza             | FRA |
|  | TURIBIO Goncalo         | POR |
|  | CASTRO LOPEZ Esteban    | ESP |
|  | RIVERO SANTAMARIA Aitor | ESP |
|  | NICOLA Martim           | POR |
|  | AZARUMYAN Artak         | EST |
|  | TANNIAN Luke            | GBR |

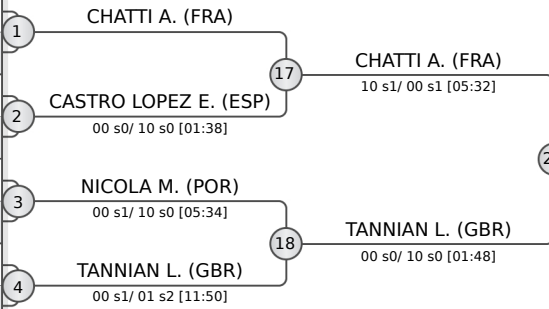

**POOL B**

|  |                     |     |
|--|---------------------|-----|
|  | SAAKYAN Alexandre   | FRA |
|  | VIGUERAS USERO Pau  | ESP |
|  | MATTHEW Schesnuik   | CAN |
|  | CHOIJILJAV Tuguldur | MGL |
|  | PEDROSA Guilherme   | POR |
|  | CUQ Axel            | FRA |

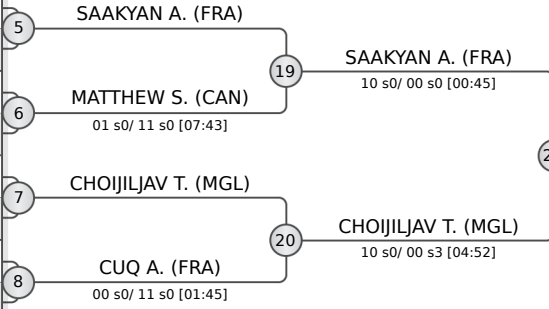

**POOL C**

|  |                       |     |
|--|-----------------------|-----|
|  | SASSI Thomas          | ITA |
|  | LEBRETON Pierre       | FRA |
|  | BROTONS CARDENAS Abel | ESP |
|  | HILL Laurence         | GBR |
|  | REIS Afonso           | POR |
|  | LLAMAS VIEJO Alex     | ESP |

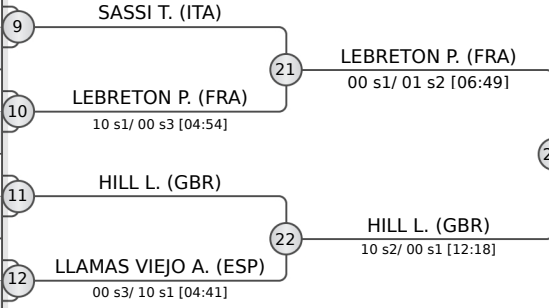

**POOL D**

|  |                      |     |
|--|----------------------|-----|
|  | ALFAIFI Saud         | KSA |
|  | TAILLEUR Basile      | FRA |
|  | PINTO Francisco      | POR |
|  | LUCAS Titouan        | FRA |
|  | MARTIN TORRES Carlos | ESP |
|  | ANDERSON Evan        | GBR |

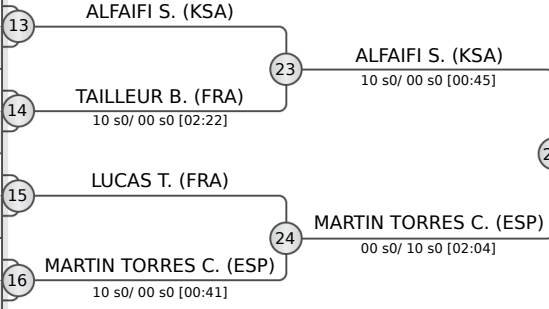

**REPECHAGE**

|                              |                       |                     |                  |
|------------------------------|-----------------------|---------------------|------------------|
| CASTRO LOPEZ E. (ESP) 29     | CASTRO LOPEZ E. (ESP) | TANNIAN L. (GBR) 33 | TANNIAN L. (GBR) |
| CUQ A. (FRA) 30              | CUQ A. (FRA)          | SAAKYAN A. (FRA) 34 | SAAKYAN A. (FRA) |
| BROTONS CARDENAS A. (ESP) 31 | SASSI T. (ITA)        | SASSI T. (ITA) 35   | SASSI T. (ITA)   |
| ANDERSON E. (GBR) 32         | LUCAS T. (FRA)        | LUCAS T. (FRA) 36   | LUCAS T. (FRA)   |
| LUCAS T. (FRA) 32            | ALFAIFI S. (KSA)      | LUCAS T. (FRA) 36   | ALFAIFI S. (KSA) |

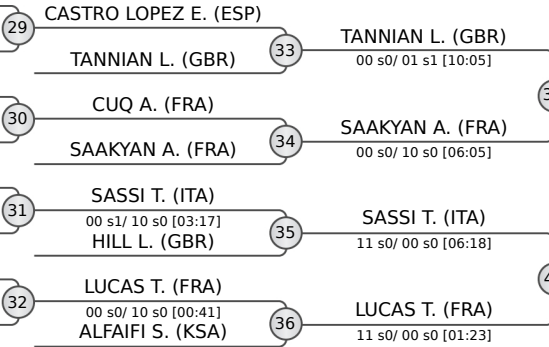

LEBRETON P. (FRA) 43  
00 s1/ 11 s0 [04:27]

LEBRETON P. (FRA) 38  
10 s0/ 00 s2 [05:52]

**FINAL RESULTS**

- LEBRETON Pierre
- CHOIJILJAV Tuguldur
- CHATTI Amza
- SAAKYAN Alexandre
- SASSI Thomas
- MARTIN TORRES Carlos
- TANNIAN Luke
- LUCAS Titouan





# Fuengirola Cadet European Cup 2023

Spain, Fuengirola, 18-19 Feb 2023

**-55 kg**  
Cadets (39)

**POOL A**

|  |                               |     |
|--|-------------------------------|-----|
|  | BRENIER Tom                   | FRA |
|  | SILVA Bernardo Santos         | POR |
|  | SANTAMARIA GONZALEZ Lucas     | ESP |
|  | FERNANDEZ DE LA IGLESIA David | ESP |
|  | GIANNONE Stefano              | ITA |
|  | ZORRETA Manuel                | POR |
|  | RICO PEDRIDO Pablo            | ESP |
|  | GARRAMONE Giovanni            | ITA |
|  | DUGDALE Freddie               | GBR |
|  | IVANOVAS Mantas               | LTU |

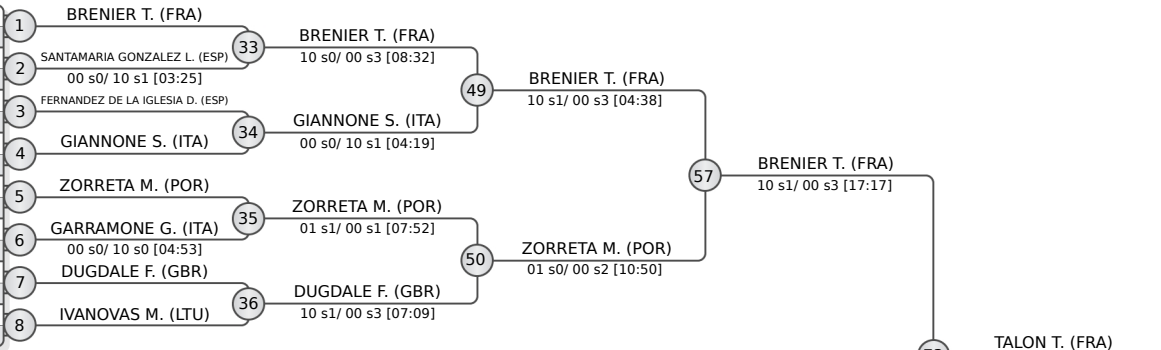

**POOL B**

|  |                      |     |
|--|----------------------|-----|
|  | RICHARDSON Luca      | NED |
|  | ELIAS JoãO           | POR |
|  | FALLAHDAR Rastin     | GBR |
|  | TALON Tiago          | FRA |
|  | SANZ AVILA Daniel    | ESP |
|  | ROSADO LOPEZ Rodrigo | ESP |
|  | SANNA Riccardo       | ITA |
|  | QUENTIN Sasha        | FRA |
|  | SHCHEKOTIN Filipp    | EST |

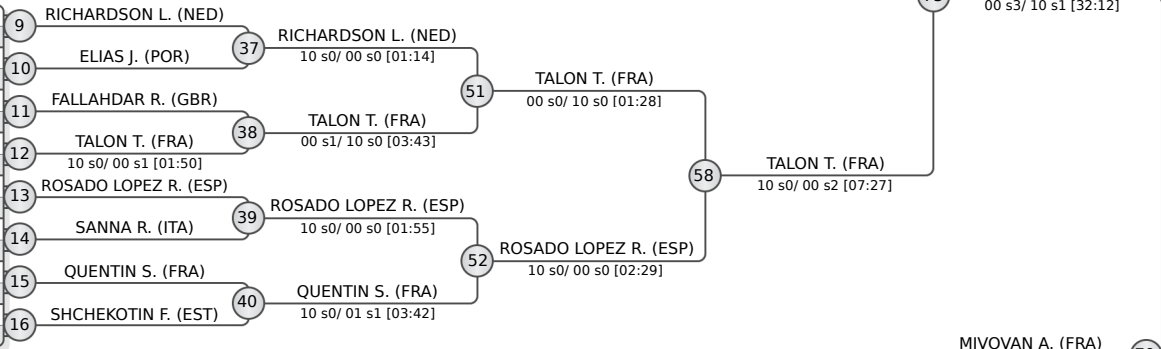

**POOL C**

|  |                     |     |
|--|---------------------|-----|
|  | CHRANIUK Jesse      | GBR |
|  | CAETANO Diogo       | POR |
|  | KAHAR Rihard Joosep | EST |
|  | PENAS MERINO Unai   | ESP |
|  | HAMADI Ihsane       | FRA |
|  | PELLIZZARO Mattia   | ITA |
|  | PAIVA Nuno          | POR |
|  | GAVAZZI Romain      | FRA |
|  | MILLAN SALAS Pablo  | ESP |
|  | GHEORGHU David      | GBR |

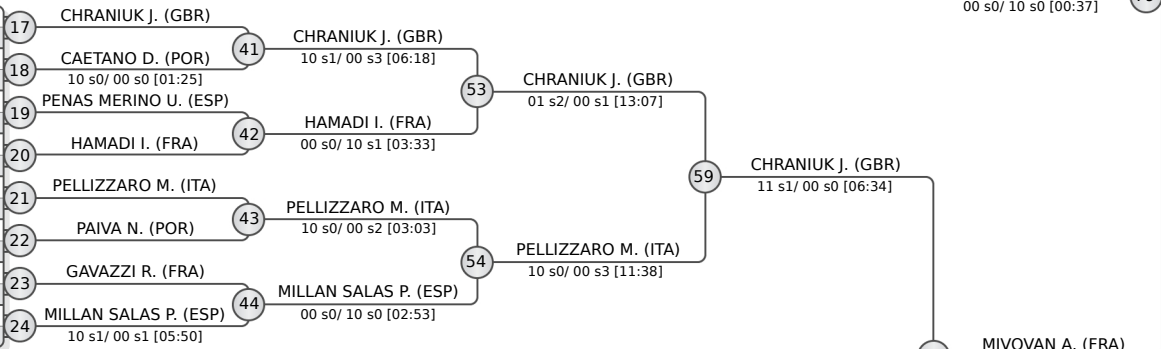

**POOL D**

|  |                      |     |
|--|----------------------|-----|
|  | GVAZDAUSKAS Raidas   | LTU |
|  | MIVOVAN Adrian       | FRA |
|  | OLMO ESTEVEZ Nicolas | ESP |
|  | REIS Guilherme       | POR |
|  | GIGILASHVILI Luka    | GBR |
|  | SUSEBEEK Bo          | NED |
|  | BOVO Ethan           | FRA |
|  | DAVYDIAN Ernest      | ESP |
|  | ASIRI Ibrahim        | KSA |
|  | CIAVURRO Niccolo     | ITA |

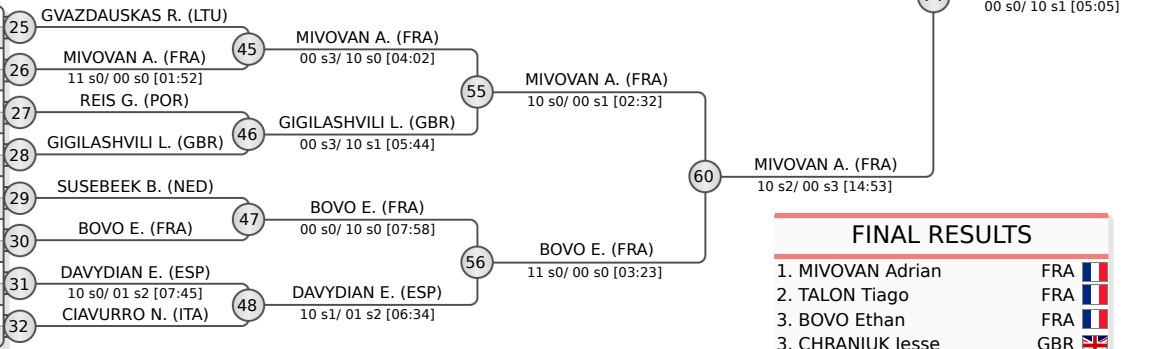

| FINAL RESULTS |                   |     |
|---------------|-------------------|-----|
| 1.            | MIVOVAN Adrian    | FRA |
| 2.            | TALON Tiago       | FRA |
| 3.            | BOVO Ethan        | FRA |
| 3.            | CHRANIUK Jesse    | GBR |
| 5.            | BRENIER Tom       | FRA |
| 5.            | ZORRETA Manuel    | POR |
| 7.            | PELLIZZARO Mattia | ITA |
| 7.            | RICHARDSON Luca   | NED |

**REPECHAGE**

|                              |    |                              |
|------------------------------|----|------------------------------|
| SANTAMARIA GONZALEZ L. (ESP) | 61 | SANTAMARIA GONZALEZ L. (ESP) |
| SANZ AVILA D. (ESP)          | 62 | FALLAHDAR R. (GBR)           |
| FALLAHDAR R. (GBR)           | 62 | RICHARDSON L. (NED)          |
| CAETANO D. (POR)             | 63 | CAETANO D. (POR)             |
| OLMO ESTEVEZ N. (ESP)        | 64 | GVAZDAUSKAS R. (LTU)         |
| GVAZDAUSKAS R. (LTU)         | 64 | GIGILASHVILI L. (GBR)        |
| GIANNONE S. (ITA)            | 65 | GIANNONE S. (ITA)            |
| FALLAHDAR R. (GBR)           | 66 | RICHARDSON L. (NED)          |
| HAMADI I. (FRA)              | 67 | HAMADI I. (FRA)              |
| GVAZDAUSKAS R. (LTU)         | 68 | GIGILASHVILI L. (GBR)        |
| GIANNONE S. (ITA)            | 69 | ZORRETA M. (POR)             |
| RICHARDSON L. (NED)          | 70 | RICHARDSON L. (NED)          |
| HAMADI I. (FRA)              | 71 | PELLIZZARO M. (ITA)          |
| GIGILASHVILI L. (GBR)        | 72 | BOVO E. (FRA)                |
| ZORRETA M. (POR)             | 75 | ZORRETA M. (POR)             |
| RICHARDSON L. (NED)          | 76 | BOVO E. (FRA)                |
| PELLIZZARO M. (ITA)          | 77 | CHRANIUK J. (GBR)            |
| BOVO E. (FRA)                | 78 | BOVO E. (FRA)                |

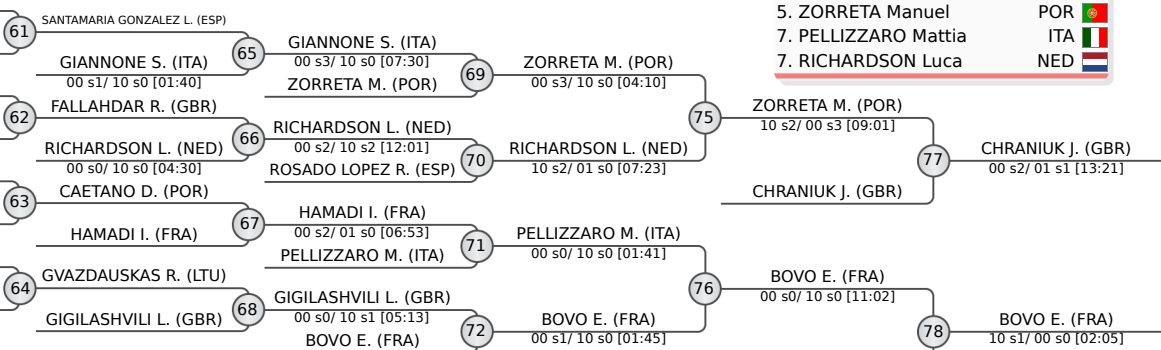



# Fuengirola Cadet European Cup 2023

Spain, Fuengirola, 18-19 Feb 2023

**-60 kg**  
Cadets (57)

**POOL A**

|    |                         |     |
|----|-------------------------|-----|
| 1  | SAGASTEGUI Eduardo      | MEX |
| 2  | SANCHEZ LOPEZ Juan      | ESP |
| 3  | COSTA Carlos            | POR |
| 4  | KPADONOU Elyas          | FRA |
| 5  | SUR Mihhail             | EST |
| 6  | SUKHBAATAR Khatanbaatar | MGL |
| 7  | KARALEVICIUS Zygimantas | LTU |
| 8  | ALKHALDI Hamad          | KSA |
| 9  | BAUTISTA SUAREZ Ruben   | ESP |
| 10 | ALMEIDA Alexandre       | POR |
| 11 | PICARD Matthieu         | FRA |
| 12 | MERINO JAEN Alvaro      | ESP |
| 13 | GONSAN Gabriel          | ITA |
| 14 | VAN HUIJSTEE Midas      | NED |
| 15 | GHIGLIERI Nicolo        | ITA |

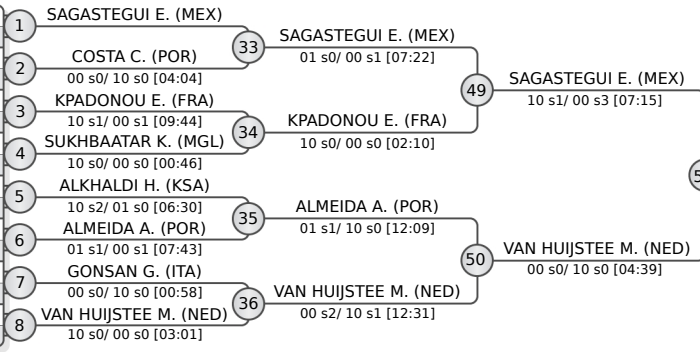

**POOL B**

|    |                             |     |
|----|-----------------------------|-----|
| 9  | GUETTARI Kais               | FRA |
| 10 | SHENGELIA Nikoloz           | GBR |
| 11 | TAVARES Guilherme           | POR |
| 12 | MELE Riccardo               | ITA |
| 13 | GAMEZ RODRIGUEZ Antonio     | ESP |
| 14 | DJURISIC Balsa              | MNE |
| 15 | ZITA Ondrej                 | CZE |
| 16 | BARTHELEMY CHAUVEL Gabin    | FRA |
| 17 | LAVRINJOV VolodõMõR         | EST |
| 18 | FRAILE RAMOS Jesus          | ESP |
| 19 | VAN DER KRUK Dinand         | NED |
| 20 | TORRECILLAS MARTINEZ Samuel | ESP |
| 21 | GATA Mateus                 | POR |
| 22 | KASPARAVICIUS Nidijus       | LTU |

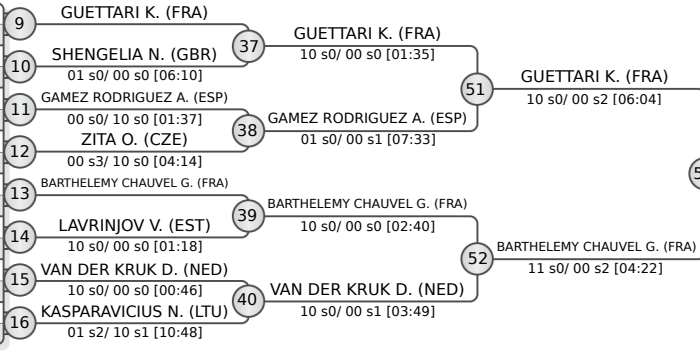

**POOL C**

|    |                         |     |
|----|-------------------------|-----|
| 17 | POLIKEVICIUS Simas      | LTU |
| 18 | NEPTON Vincent          | CAN |
| 19 | LYSOGOR CHERKESOV Maxim | ESP |
| 20 | PALILLO Thomas          | ITA |
| 21 | MITCHELL Alfie          | GBR |
| 22 | PATA Leonardo           | POR |
| 23 | DIETEMANN Nathan        | FRA |
| 24 | ADRIANO Maxence         | FRA |
| 25 | SOARES Afonso           | POR |
| 26 | MIRANDA GALINDO Eduardo | ESP |
| 27 | FELIO ROBLES Alejandro  | ESP |
| 28 | ATTANASI Cristian       | ITA |
| 29 | JAKIMOV Robert          | EST |
| 30 | GIMENEZ Maxence         | FRA |

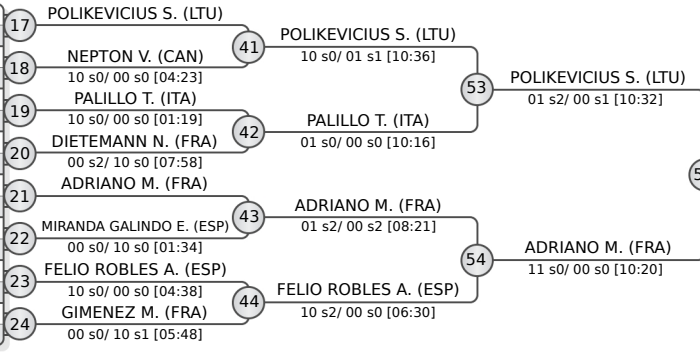

**POOL D**

|    |                             |     |
|----|-----------------------------|-----|
| 25 | SILVA David                 | POR |
| 26 | GRACIA SANCHEZ Leo          | ESP |
| 27 | COLIN Zachary               | FRA |
| 28 | FLORES RIPALDA Jose Antonio | ESP |
| 29 | BRONSVOORD Jarno            | NED |
| 30 | VAGULIS Danas               | LTU |
| 31 | MCWATT Ross                 | GBR |
| 32 | CLARK Peter                 | EST |
| 33 | DUARTE Goncalo              | POR |
| 34 | UTRERO CRESPO Iker          | ESP |
| 35 | MARTIN LOBO Pablo           | ESP |
| 36 | GBINGBEHI Johan             | FRA |
| 37 | GHIGLIERI Edoardo           | ITA |
| 38 | SILVA Manuel                | POR |

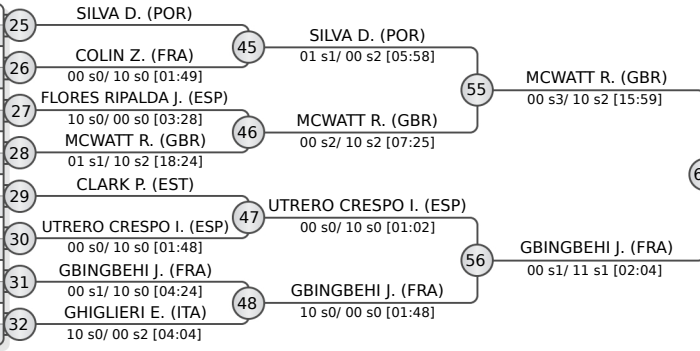

| FINAL RESULTS |                          |     |
|---------------|--------------------------|-----|
| 1.            | GUETTARI Kais            | FRA |
| 2.            | ADRIANO Maxence          | FRA |
| 3.            | SAGASTEGUI Eduardo       | MEX |
| 3.            | GBINGBEHI Johan          | FRA |
| 5.            | UTRERO CRESPO Iker       | ESP |
| 5.            | BARTHELEMY CHAUVEL Gabin | FRA |
| 7.            | MIRANDA GALINDO Eduardo  | ESP |
| 7.            | COSTA Carlos             | POR |

**REPECHAGE**

|    |                          |
|----|--------------------------|
| 61 | COSTA C. (POR)           |
| 62 | SHENGELIA N. (GBR)       |
| 63 | MIRANDA GALINDO E. (ESP) |
| 64 | GHIGLIERI E. (ITA)       |

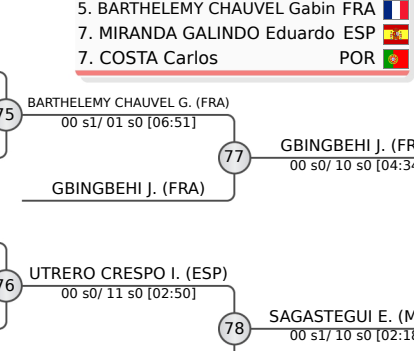
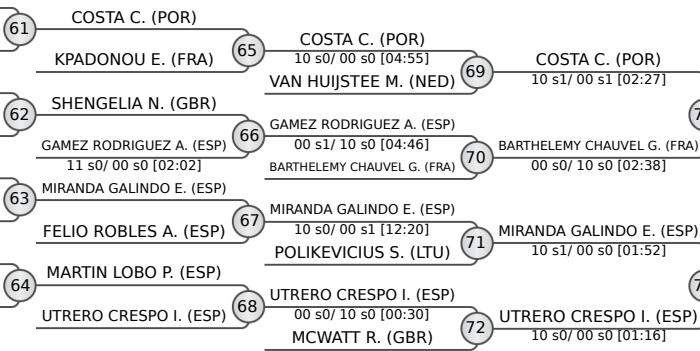



# Fuengirola Cadet European Cup 2023

Spain, Fuengirola, 18-19 Feb 2023

**-66 kg**  
Cadets (39)

**POOL A**

|   |                            |   |                                       |
|---|----------------------------|---|---------------------------------------|
| 1 | JANEIRO Rodrigo (POR)      | 1 | JANEIRO R. (POR)                      |
| 2 | CARAZO LACUNZA Julio (ESP) | 2 | CARAZO LACUNZA J. (ESP) 33            |
| 3 | SALAH Mehdi (FRA)          | 3 | SALAH M. (FRA) 11 s1/ 00 s3 [04:00]   |
| 4 | PONTE BARCA Raul (ESP)     | 4 | NOVIKOV J. (EST) 34                   |
| 5 | NOVIKOV Jegor (EST)        | 5 | NOVIKOV J. (EST) 00 s0/ 01 s2 [07:36] |
| 6 | FITHANE Fahd (CAN)         | 6 | FITHANE F. (CAN)                      |
| 7 | PLA ZANUY Sandro (ESP)     | 7 | PLA ZANUY S. (ESP) 35                 |
| 8 | HUTCHINSON Travis (GBR)    | 8 | HUTCHINSON T. (GBR)                   |
| 9 | CARABOTTO Giuseppe (ITA)   | 9 | CARABOTTO G. (ITA) 36                 |

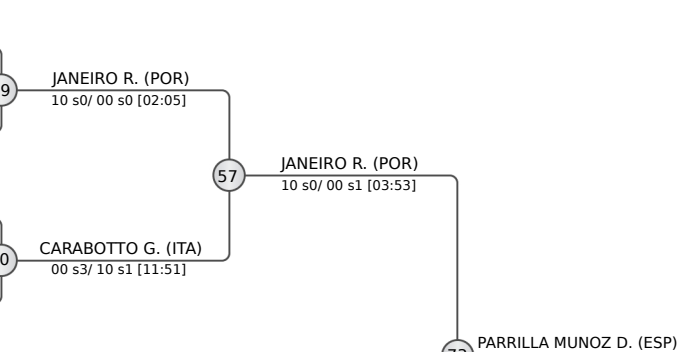

**POOL B**

|    |                             |    |                                              |
|----|-----------------------------|----|----------------------------------------------|
| 9  | DAVIES Peter (GBR)          | 9  | DAVIES P. (GBR)                              |
| 10 | LENER Medhi (FRA)           | 10 | LENER M. (FRA) 37                            |
| 11 | NICOSIA Enrico (ITA)        | 11 | NICOSIA E. (ITA)                             |
| 12 | JIMENEZ LOPEZ David (ESP)   | 12 | FAIRAQ A. (KSA) 38                           |
| 13 | FAIRAQ Abdulaziz (KSA)      | 13 | FAIRAQ A. (KSA) 00 s1/ 11 s0 [02:47]         |
| 14 | CHAMBERS-EDUTIE Kyras (GBR) | 14 | CHAMBERS-EDUTIE K. (GBR)                     |
| 15 | HARROU Anas (FRA)           | 15 | PARRILLA MUNOZ D. (ESP) 39                   |
| 16 | PARRILLA MUNOZ Daniel (ESP) | 16 | PARRILLA MUNOZ D. (ESP) 00 s0/ 10 s0 [02:04] |
| 17 | FISER Stepan (CZE)          | 17 | FISER S. (CZE) 40                            |
| 18 | TREJO QUINTANA Marcos (ESP) | 18 | TREJO QUINTANA M. (ESP) 40                   |

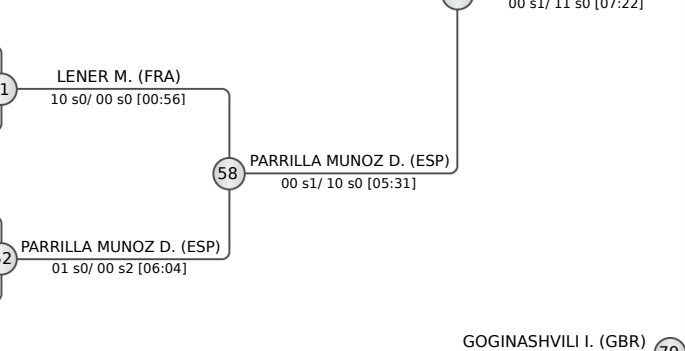

**POOL C**

|    |                               |    |                             |
|----|-------------------------------|----|-----------------------------|
| 17 | GOGINASHVILI Irakli (GBR)     | 17 | GOGINASHVILI I. (GBR)       |
| 18 | MANNEBEEK Luuk (NED)          | 18 | MANNEBEEK L. (NED) 41       |
| 19 | JAKIMOV Edward (EST)          | 19 | JAKIMOV E. (EST)            |
| 20 | AL MOHAMMAD Naser (FRA)       | 20 | AL MOHAMMAD N. (FRA)        |
| 21 | MARI ALCUBIERRE David (ESP)   | 21 | MARI ALCUBIERRE D. (ESP) 42 |
| 22 | BICORNGNI Alessandro (ITA)    | 22 | BICORNGNI A. (ITA)          |
| 23 | QUEREDA YURICE Hugo (ESP)     | 23 | QUEREDA YURICE H. (ESP) 43  |
| 24 | CABROL Lilian (FRA)           | 24 | CABROL L. (FRA) 44          |
| 25 | RICO Rafael (POR)             | 25 | RICO R. (POR)               |
| 26 | PALACIOS ROMERO Beltran (ESP) | 26 | PALACIOS ROMERO B. (ESP) 44 |

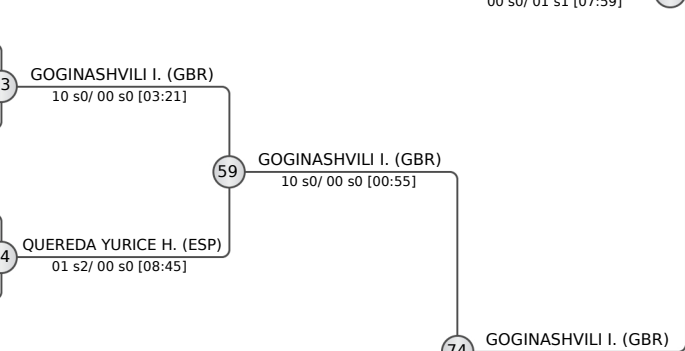

**POOL D**

|    |                                       |    |                                     |
|----|---------------------------------------|----|-------------------------------------|
| 25 | JOVSA Deividas (LTU)                  | 25 | JOVSA D. (LTU)                      |
| 26 | INFANZON OCAMPO Carlos (ESP)          | 26 | INFANZON OCAMPO C. (ESP) 45         |
| 27 | TEMCIUC Denis (ITA)                   | 27 | TEMCIUC D. (ITA)                    |
| 28 | NZE BEKALE Kylian (FRA)               | 28 | NZE BEKALE K. (FRA) 46              |
| 29 | MELO Vicente (POR)                    | 29 | MELO V. (POR) 46                    |
| 30 | BOLZAN Nikita (LTU)                   | 30 | BOLZAN N. (LTU) 47                  |
| 31 | LOPEZ DE GUEREÑO ARMADA Ignacio (ESP) | 31 | LOPEZ DE GUEREÑO ARMADA I. (ESP) 47 |
| 32 | MUINO BOVE Joaquim (FRA)              | 32 | MUINO BOVE J. (FRA) 47              |
| 33 | DENIZ Thomas (GBR)                    | 33 | DENIZ T. (GBR) 48                   |
| 34 | GARCIA ESPAÑA Jon (ESP)               | 34 | GARCIA ESPAÑA J. (ESP) 48           |

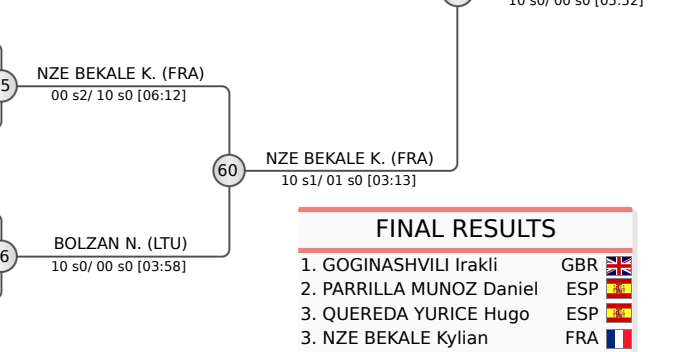

| FINAL RESULTS |                        |     |
|---------------|------------------------|-----|
| 1.            | GOGINASHVILI Irakli    | GBR |
| 2.            | PARRILLA MUNOZ Daniel  | ESP |
| 3.            | QUEREDA YURICE Hugo    | ESP |
| 3.            | NZE BEKALE Kylian      | FRA |
| 5.            | JANEIRO Rodrigo        | POR |
| 5.            | CARAZO LACUNZA Julio   | ESP |
| 7.            | INFANZON OCAMPO Carlos | ESP |
| 7.            | CHAMBERS-EDUTIE Kyras  | GBR |

**REPECHAGE**

|    |                          |    |                          |
|----|--------------------------|----|--------------------------|
| 61 | CARAZO LACUNZA J. (ESP)  | 61 | CARAZO LACUNZA J. (ESP)  |
| 62 | HARROU A. (FRA)          | 62 | HARROU A. (FRA)          |
| 63 | CHAMBERS-EDUTIE K. (GBR) | 63 | CHAMBERS-EDUTIE K. (GBR) |
| 64 | MANNEBEEK L. (NED)       | 64 | MANNEBEEK L. (NED)       |
| 65 | MELO V. (POR)            | 65 | MELO V. (POR)            |

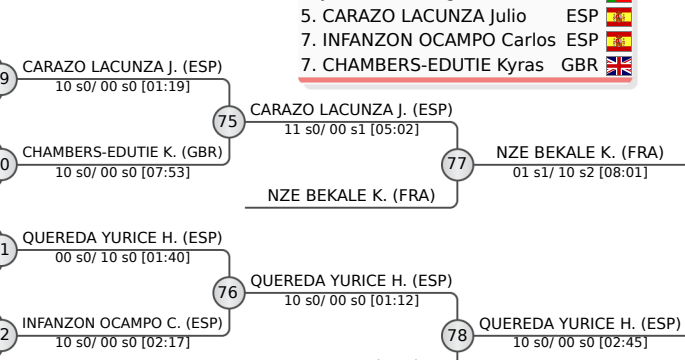



# Fuengirola Cadet European Cup 2023

Spain, Fuengirola, 18-19 Feb 2023

**-73 kg**  
Cadets (37)

**POOL A**

|     |                      |     |   |                      |    |
|-----|----------------------|-----|---|----------------------|----|
| ITA | TAVOLETTA Lucio      | ITA | 1 | TAVOLETTA L. (ITA)   |    |
| ESP | ACHOUR ARTILES Salem | EST | 2 | SAAR K. (EST)        | 33 |
| EST | SAAR Karl            | EST |   |                      |    |
| MEX | RAMIREZ Rafael       | MEX | 3 | RAMIREZ R. (MEX)     |    |
| GBR | RUBIO RUIZ Oriol     | GBR | 4 | RUBIO RUIZ O. (GBR)  | 34 |
| FRA | BELLEVAL Jawanys     | FRA | 5 | BELLEVAL J. (FRA)    |    |
| ESP | ORTIZ RUEDA David    | ESP | 6 | ORTIZ RUEDA D. (ESP) | 35 |
| GBR | HOPE Isaac           | GBR | 7 | HOPE I. (GBR)        |    |
| LTU | VAISVILA Julius      | LTU | 8 | VAISVILA J. (LTU)    | 36 |

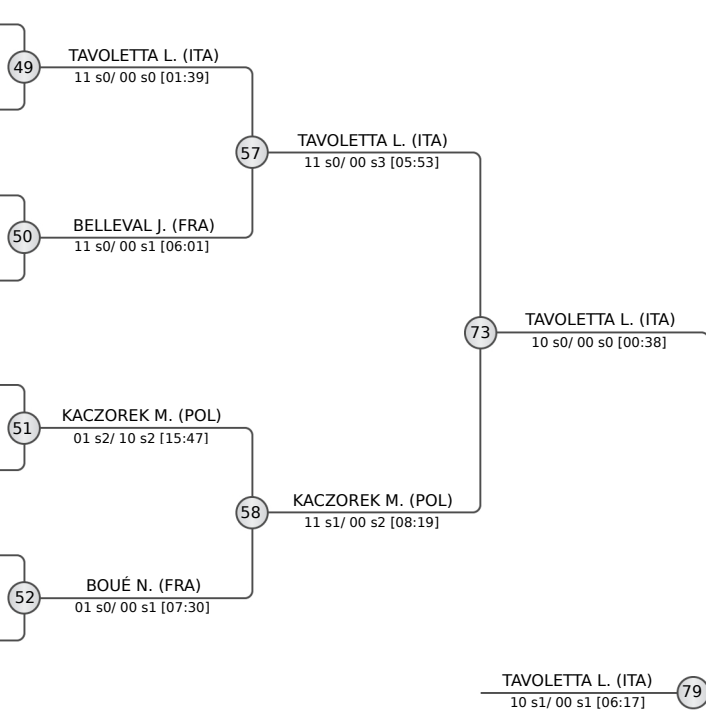

**POOL B**

|     |                             |     |    |                        |    |
|-----|-----------------------------|-----|----|------------------------|----|
| EST | DIKAJEV Saad                | EST | 9  | DIKAJEV S. (EST)       |    |
| ESP | SUAREZ MEDINA Bayron Andres | ESP | 10 | SUAREZ MEDINA B. (ESP) | 37 |
| POR | MAGALHAES Tomas             | POR | 11 | MAGALHAES T. (POR)     |    |
| POL | KACZOREK Mikolaj            | POL | 12 | KACZOREK M. (POL)      | 38 |
| GBR | HEFFERNAN Eden              | GBR | 13 | HEFFERNAN E. (GBR)     |    |
| ESP | GARCIA TENA Javier          | ESP | 14 | BOUÉ N. (FRA)          | 39 |
| FRA | BOUÉ Noah                   | FRA |    |                        |    |
| CRO | RADOLOVIC Edvard            | CRO | 15 | RADOLOVIC E. (CRO)     |    |
| EST | TALPAS Armin-Ott            | EST | 16 | TALPAS A. (EST)        | 40 |

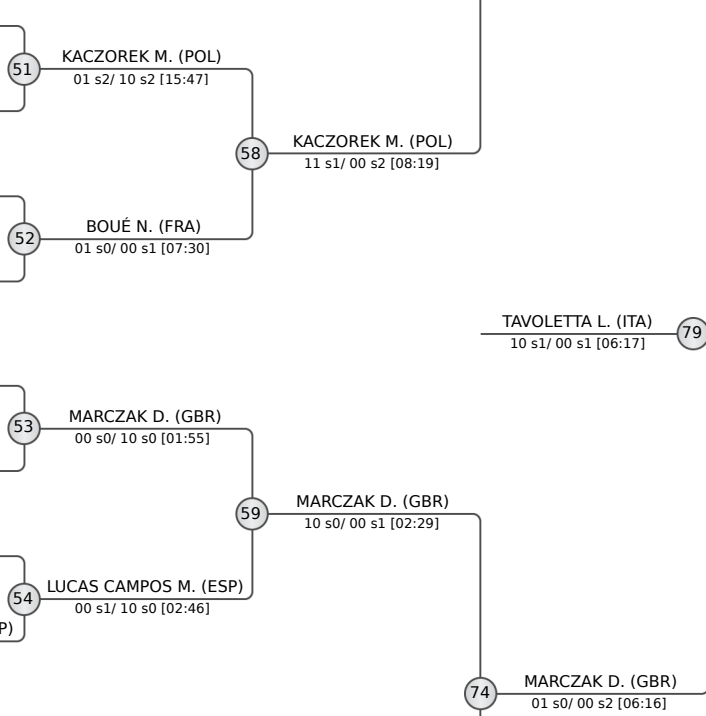

**POOL C**

|     |                           |     |    |                       |    |
|-----|---------------------------|-----|----|-----------------------|----|
| ITA | MOLINARO Giulio           | ITA | 17 | MOLINARO G. (ITA)     |    |
| POR | MOURA Guilherme           | POR | 18 | MOURA G. (POR)        | 41 |
| ESP | MARTIN BRILLO Aaron       | EST | 19 | VÄÄT R. (EST)         |    |
| EST | VÄÄT Rainis               | EST |    |                       |    |
| GBR | MARCZAK Derek             | GBR | 20 | MARCZAK D. (GBR)      | 42 |
| EST | KASESALU Christian-Marcus | EST | 21 | KASESALU C. (EST)     |    |
| FRA | GACHET Enzo               | FRA | 22 | GACHET E. (FRA)       | 43 |
| ESP | LUCAS CAMPOS Miguel       | ESP | 23 | LUCAS CAMPOS M. (ESP) |    |
| LTU | RACKA Norbertas           | LTU | 24 | RACKA N. (LTU)        | 44 |

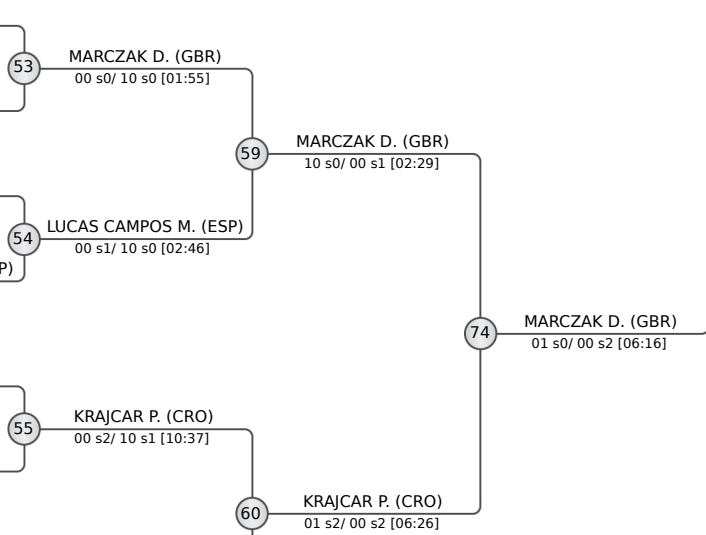

**POOL D**

|     |                     |     |    |                       |    |
|-----|---------------------|-----|----|-----------------------|----|
| MGL | BADRAKH Shinetulga  | MGL | 25 | BADRAKH S. (MGL)      |    |
| ESP | MOYA MORILLA Nauzet | ESP | 26 | MOYA MORILLA N. (ESP) | 45 |
| LTU | GRABLEVSKIJ Daniel  | LTU | 27 | GRABLEVSKIJ D. (LTU)  |    |
| EST | SIIM Ralf Oskar     | EST | 28 | KRAJCAR P. (CRO)      | 46 |
| CRO | KRAJCAR Paolo       | CRO |    |                       |    |
| GBR | FINLAY Strang       | GBR | 29 | FINLAY S. (GBR)       |    |
| NED | DOBBELAER Kynan     | NED | 30 | DOBBELAER K. (NED)    | 47 |
| POR | DUARTE Junior       | POR | 31 | DUARTE J. (POR)       |    |
| ESP | MARIN PIFARRE Adria | ESP | 32 | JACQUELINE T. (FRA)   | 48 |
| FRA | JACQUELINE Thomas   | FRA |    |                       |    |

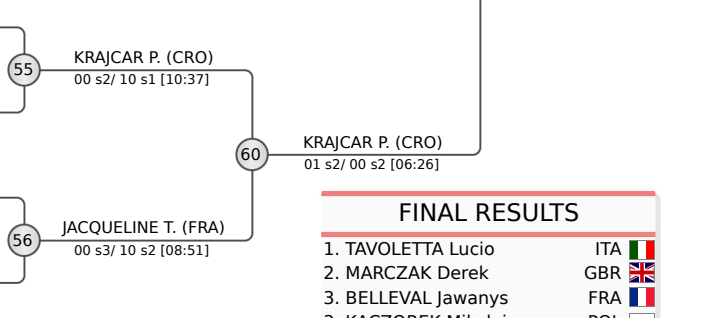

| FINAL RESULTS |                    |     |
|---------------|--------------------|-----|
| 1.            | TAVOLETTA Lucio    | ITA |
| 2.            | MARCZAK Derek      | GBR |
| 3.            | BELLEVAL Jawanys   | FRA |
| 3.            | KACZOREK Mikolaj   | POL |
| 5.            | KRAJCAR Paolo      | CRO |
| 5.            | BADRAKH Shinetulga | MGL |
| 7.            | DIKAJEV Saad       | EST |
| 7.            | MOLINARO Giulio    | ITA |

**REPECHAGE**

|    |                      |    |                   |    |                   |
|----|----------------------|----|-------------------|----|-------------------|
| 61 | SAAR K. (EST)        | 65 | SAAR K. (EST)     | 69 | BELLEVAL J. (FRA) |
|    |                      |    |                   |    |                   |
|    |                      |    |                   |    |                   |
| 62 | MAGALHAES T. (POR)   | 66 | DIKAJEV S. (EST)  | 70 | DIKAJEV S. (EST)  |
|    |                      |    |                   |    |                   |
|    |                      |    |                   |    |                   |
| 63 | VÄÄT R. (EST)        | 67 | MOLINARO G. (ITA) | 71 | MOLINARO G. (ITA) |
|    |                      |    |                   |    |                   |
|    |                      |    |                   |    |                   |
| 64 | GRABLEVSKIJ D. (LTU) | 68 | BADRAKH S. (MGL)  | 72 | BADRAKH S. (MGL)  |
|    |                      |    |                   |    |                   |
|    |                      |    |                   |    |                   |

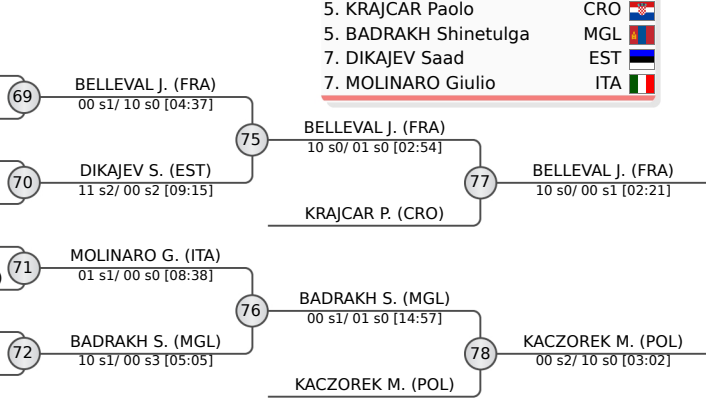



# Fuengirola Cadet European Cup 2023

Spain, Fuengirola, 18-19 Feb 2023

**-81 kg**  
Cadets (36)

**POOL A**

|   |                                 |    |                        |
|---|---------------------------------|----|------------------------|
| 1 | D'URBANO Alessandro Bruno (ITA) | 1  | D'URBANO A. (ITA)      |
| 2 | ROBIN Lenny (FRA)               | 33 | D'URBANO A. (ITA)      |
| 3 | FREIRE GONZALEZ Nicolas (ESP)   |    | 10 s0/ 00 s1 [05:21]   |
| 4 | DIAS Afonso (POR)               | 34 | DIAS A. (POR)          |
| 5 | ENERIZ GARCIA Arkaitz (ESP)     |    | 00 s1/ 10 s0 [04:55]   |
| 6 | KOMIN Kirill (EST)              | 35 | ENERIZ GARCIA A. (ESP) |
| 7 | JAKS Adam (CZE)                 |    | 10 s1/ 00 s2 [08:08]   |
| 8 | RILEY George (GBR)              | 36 | JAKS A. (CZE)          |
|   | GENEVICIUS Tajus (LTU)          |    | 10 s0/ 00 s0 [04:05]   |

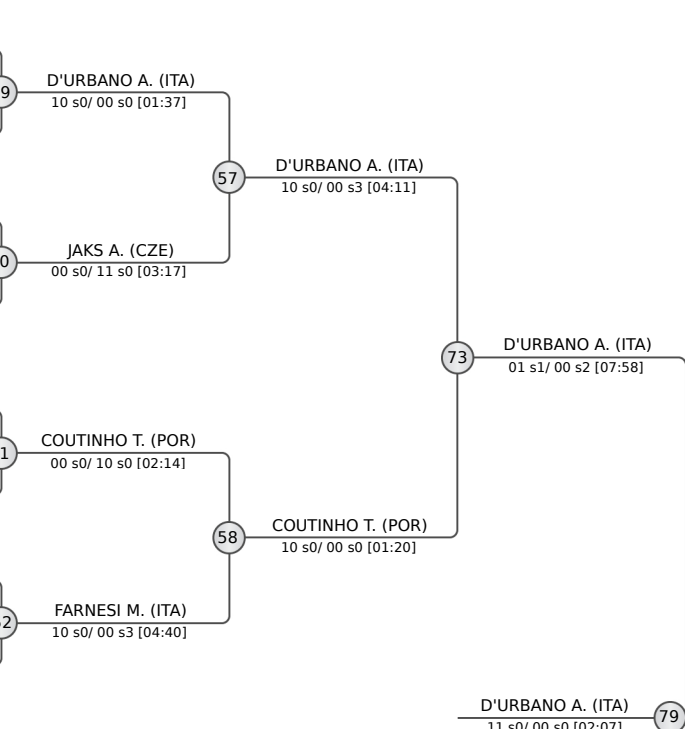

**POOL B**

|    |                                 |    |                      |
|----|---------------------------------|----|----------------------|
| 9  | CLAVERIO Marco (ITA)            | 9  | CLAVERIO M. (ITA)    |
| 10 | GNAFOUA David (FRA)             | 37 | GNAFOUA D. (FRA)     |
| 11 | COUTINHO Tiago (POR)            |    | 00 s0/ 11 s0 [04:05] |
| 12 | BRABANDER Tim (NED)             | 38 | COUTINHO T. (POR)    |
| 13 | YANKEVYCH NAGORNIY Bogdan (ESP) |    | 10 s0/ 00 s1 [01:56] |
| 14 | FARNESI Matteo (ITA)            | 39 | COUTINHO T. (POR)    |
| 15 | HANNETELLE Nils (FRA)           |    | 10 s0/ 00 s0 [01:28] |
| 16 | VAHTER Taavi (EST)              | 40 | FARNESI M. (ITA)     |
|    | ARILLA NASARRE Raul (ESP)       |    | 10 s2/ 00 s3 [15:11] |
|    |                                 |    | 10 s0/ 00 s3 [04:40] |
|    |                                 |    | 00 s0/ 10 s0 [01:18] |

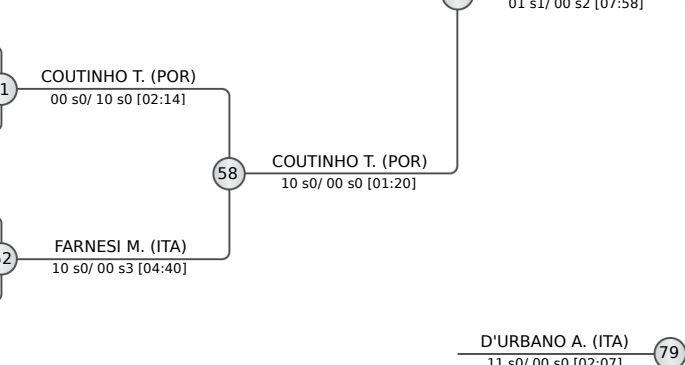

**POOL C**

|    |                                |    |                           |
|----|--------------------------------|----|---------------------------|
| 17 | HUKKANEN Aleksii (FIN)         | 17 | HUKKANEN A. (FIN)         |
| 18 | TCHELISHVILI Akaki (ESP)       | 41 | HUKKANEN A. (FIN)         |
| 19 | COPAT Leonardo (ITA)           |    | 01 s2/ 00 s0 [14:06]      |
| 20 | NARKUS Vygidar (LTU)           | 42 | COPAT L. (ITA)            |
| 21 | RAIDMA Kaspar (EST)            |    | 10 s0/ 00 s0 [03:28]      |
| 22 | GROSSIR LEOUSSIS Dylan (FRA)   | 43 | GROSSIR LEOUSSIS D. (FRA) |
| 23 | RODRIGUEZ NARANJO Leonel (ESP) |    | 10 s1/ 01 s0 [04:28]      |
| 24 | DOMBERG Tõnis (EST)            | 44 | GROSSIR LEOUSSIS D. (FRA) |
|    | CUNHA Bernardo (POR)           |    | 10 s0/ 00 s0 [01:51]      |
|    |                                |    | 00 s0/ 10 s0 [01:53]      |

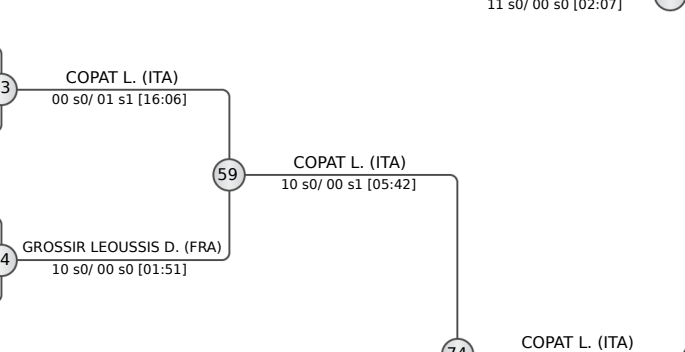

**POOL D**

|    |                              |    |                        |
|----|------------------------------|----|------------------------|
| 25 | GRELIER Mael (FRA)           | 25 | GRELIER M. (FRA)       |
| 26 | JOLKIN Nikita (EST)          | 45 | GRELIER M. (FRA)       |
| 27 | STOJANOWSKI Aleksander (GBR) |    | 10 s2/ 00 s3 [10:12]   |
| 28 | GENYS Majus (LTU)            | 46 | SORIANO MORON D. (ESP) |
| 29 | SORIANO MORON Darío (ESP)    |    | 00 s0/ 11 s2 [05:17]   |
| 30 | SARBOCH Vit (CZE)            | 47 | SORIANO MORON D. (ESP) |
| 31 | ANTUNES Victor (POR)         |    | 00 s0/ 10 s0 [02:41]   |
| 32 | TRILLO VALEIRO Miguel (ESP)  | 48 | SARBOCH V. (CZE)       |
|    | ZALAGH Redouane (FRA)        |    | 10 s0/ 00 s1 [02:04]   |
|    |                              |    | 00 s3/ 11 s1 [05:49]   |

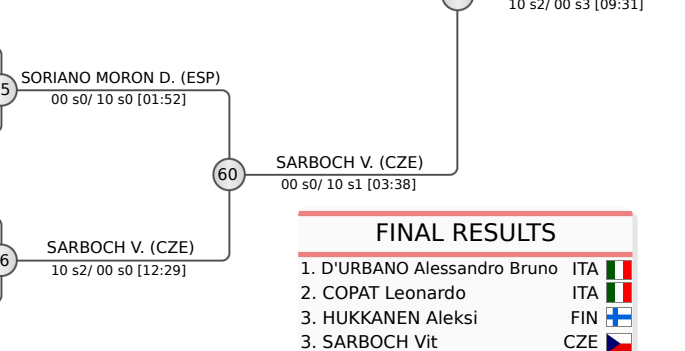

| FINAL RESULTS |                           |     |
|---------------|---------------------------|-----|
| 1.            | D'URBANO Alessandro Bruno | ITA |
| 2.            | HUKKANEN Aleksii          | FIN |
| 3.            | SARBOCH Vit               | CZE |
| 5.            | COUTINHO Tiago            | POR |
| 5.            | JAKS Adam                 | CZE |
| 7.            | GNAFOUA David             | FRA |
| 7.            | ZALAGH Redouane           | FRA |

**REPECHAGE**

|    |                             |    |                      |
|----|-----------------------------|----|----------------------|
| 61 | ROBIN L. (FRA)              | 61 | ROBIN L. (FRA)       |
| 62 | BRABANDER T. (NED)          | 65 | ROBIN L. (FRA)       |
| 63 | YANKEVYCH NAGORNIY B. (ESP) |    | 10 s0/ 00 s0 [02:47] |
| 64 | NARKUS V. (LTU)             | 66 | JAKS A. (CZE)        |
| 65 | RAIDMA K. (EST)             |    | 00 s0/ 10 s0 [02:17] |
| 66 | ANTUNES V. (POR)            | 67 | GNAFOUA D. (FRA)     |
|    |                             |    | 00 s0/ 10 s0 [04:07] |
|    |                             |    | 10 s1/ 00 s2 [13:57] |
|    |                             |    | 00 s1/ 01 s2 [11:40] |
|    |                             |    | 10 s1/ 00 s0 [02:16] |
|    |                             |    | 00 s2/ 11 s1 [05:20] |
|    |                             |    | 10 s0/ 00 s0 [01:50] |

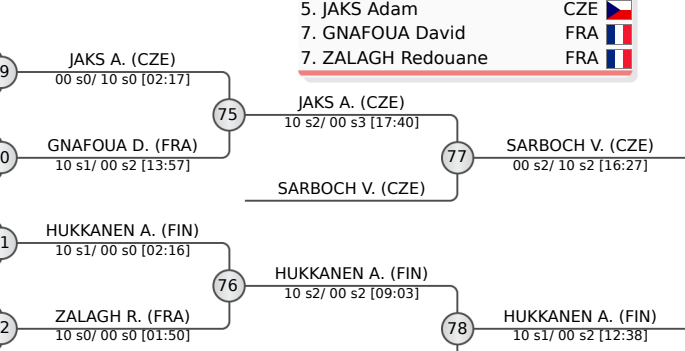



# Fuengirola Cadet European Cup 2023

Spain, Fuengirola, 18-19 Feb 2023

**-90 kg**  
Cadets (20)

**POOL A**

|  |                            |     |
|--|----------------------------|-----|
|  | MINCINESI Cristiano        | ITA |
|  | STOROZHUK Danilo           | POR |
|  | ROMERO NAKHIL Carlos Karim | ESP |
|  | NWAHA NGON A. Avielian     | FRA |
|  | CUPALOV Jegor              | LTU |

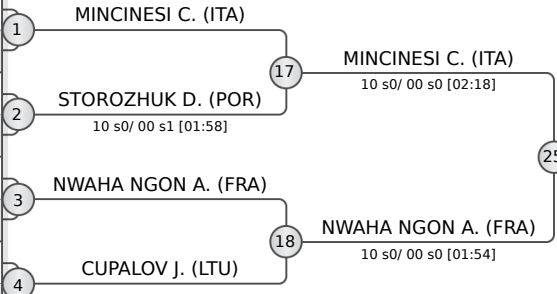

**POOL B**

|  |                     |     |
|--|---------------------|-----|
|  | ALMALKI Mohammed    | KSA |
|  | CALDERON LASO Pablo | ESP |
|  | SONNTAG Gaya        | FRA |
|  | USIN Huko Pärtel    | EST |
|  | BLACK Noah          | GBR |

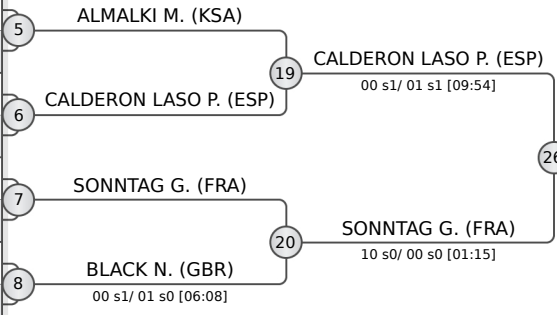

**POOL C**

|  |                             |     |
|--|-----------------------------|-----|
|  | KOTCHE Daniel               | FRA |
|  | RAMIREZ PEREZ Antonio Aixel | ESP |
|  | JARDIM Tiago                | POR |
|  | VAN BILZEM Bas              | NED |
|  | LAVADO RETA Aritz           | ESP |

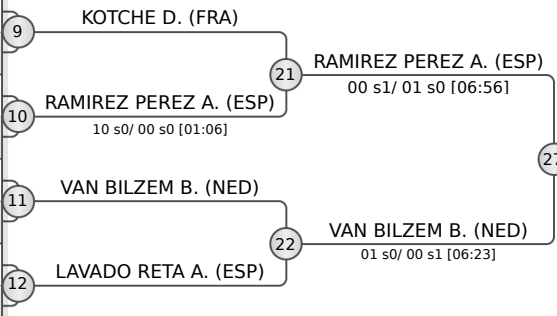

**POOL D**

|  |                       |     |
|--|-----------------------|-----|
|  | KANDELAKI David       | FRA |
|  | ORG Andris            | EST |
|  | KRZYNOWEK Oskar       | POL |
|  | LOZANO PASTOR Guillem | ESP |
|  | SALTONAS Aldas        | LTU |

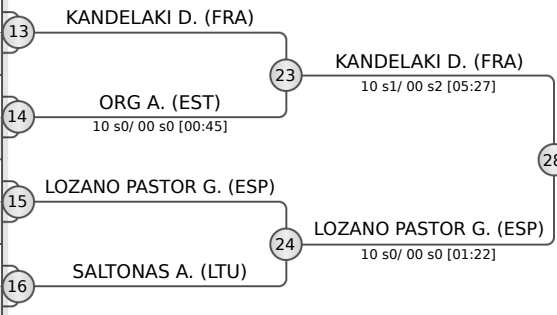

**REPECHAGE**

|                    |    |                     |    |                        |
|--------------------|----|---------------------|----|------------------------|
| STOROZHUK D. (POR) | 29 | STOROZHUK D. (POR)  | 33 | NWAHA NGON A. (FRA)    |
| BLACK N. (GBR)     | 30 | BLACK N. (GBR)      | 34 | CALDERON LASO P. (ESP) |
| JARDIM T. (POR)    | 31 | KOTCHE D. (FRA)     | 35 | KOTCHE D. (FRA)        |
| KOTCHE D. (FRA)    | 31 | VAN BILZEM B. (NED) | 35 | KOTCHE D. (FRA)        |
| SALTONAS A. (LTU)  | 32 | SALTONAS A. (LTU)   | 36 | KANDELAKI D. (FRA)     |
| SALTONAS A. (LTU)  | 32 | KANDELAKI D. (FRA)  | 36 | KANDELAKI D. (FRA)     |

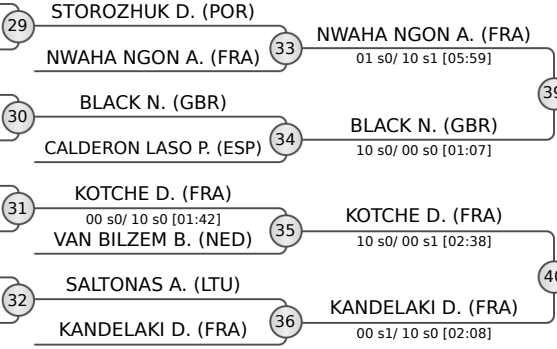

| FINAL RESULTS |                             |     |
|---------------|-----------------------------|-----|
| 1.            | MINCINESI Cristiano         | ITA |
| 2.            | LOZANO PASTOR Guillem       | ESP |
| 3.            | RAMIREZ PEREZ Antonio Aixel | ESP |
| 3.            | SONNTAG Gaya                | FRA |
| 5.            | NWAHA NGON Avielian         | FRA |
| 5.            | KOTCHE Daniel               | FRA |
| 7.            | BLACK Noah                  | GBR |
| 7.            | KANDELAKI David             | FRA |





# Fuengirola Cadet European Cup 2023

Spain, Fuengirola, 18-19 Feb 2023

**+90 kg**  
Cadets (16)

**POOL A**

|  |                     |     |
|--|---------------------|-----|
|  | BU KHAMSIN Mohammed | KSA |
|  | BOUCHARD Jean David | CAN |
|  | MARTIN ROBLEDO Iker | ESP |
|  | BACIU Loan          | FRA |

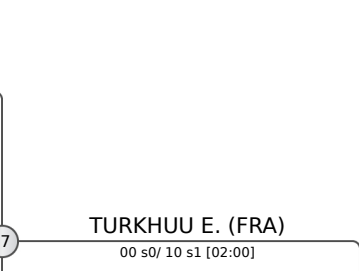
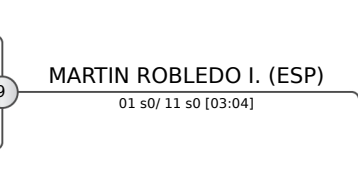
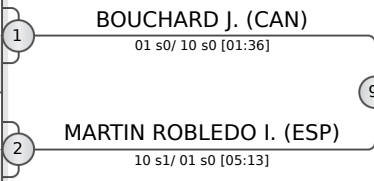

**POOL B**

|  |                                   |     |
|--|-----------------------------------|-----|
|  | RUIZ DIAZ Juan Jose               | ESP |
|  | TURKHUU Edouard                   | FRA |
|  | GUERREIRO Romeu                   | POR |
|  | ROJAS ARENCIBIA Alejandro Antonio | ESP |

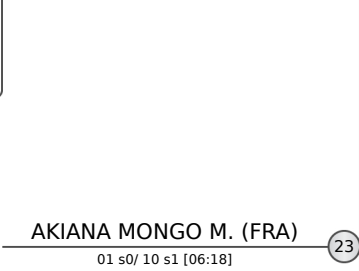
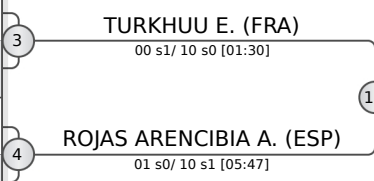

**POOL C**

|  |                          |     |
|--|--------------------------|-----|
|  | AKIANA MONGO Matheo      | FRA |
|  | MĀSAK Marek-Adrian       | EST |
|  | PAULAUSKAS Lukas         | LTU |
|  | MARTIN ROBLEDO Alejandro | ESP |

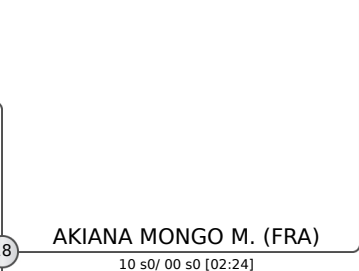
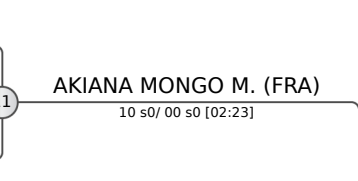
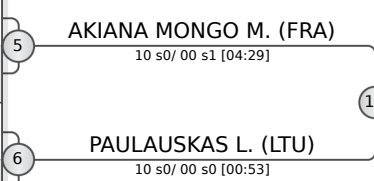

**POOL D**

|  |                              |     |
|--|------------------------------|-----|
|  | DA COSTA Jean Pascal Bi Goly | FRA |
|  | GRACIA CONCHA Guillermo      | ESP |
|  | MIMOSO Ricardo               | POR |
|  | DOMINGUEZ MILAN Arnau        | ESP |

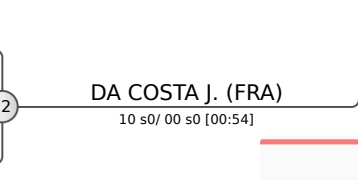

**FINAL RESULTS**

|    |                                   |     |  |
|----|-----------------------------------|-----|--|
| 1. | AKIANA MONGO Matheo               | FRA |  |
| 2. | TURKHUU Edouard                   | FRA |  |
| 3. | DA COSTA Jean Pascal Bi Goly      | FRA |  |
| 3. | MĀSAK Marek-Adrian                | EST |  |
| 5. | ROJAS ARENCIBIA Alejandro Antonio | ESP |  |
| 5. | MARTIN ROBLEDO Iker               | ESP |  |
| 7. | BOUCHARD Jean David               | CAN |  |
| 7. | GRACIA CONCHA Guillermo           | ESP |  |

**REPECHAGE**

|                          |                          |
|--------------------------|--------------------------|
| BACIU L. (FRA)           | BOUCHARD J. (CAN)        |
| BOUCHARD J. (CAN)        | RUIZ DIAZ J. (ESP)       |
| RUIZ DIAZ J. (ESP)       | ROJAS ARENCIBIA A. (ESP) |
| ROJAS ARENCIBIA A. (ESP) | MĀSAK M. (EST)           |
| MĀSAK M. (EST)           | PAULAUSKAS L. (LTU)      |
| PAULAUSKAS L. (LTU)      | GRACIA CONCHA G. (ESP)   |
| GRACIA CONCHA G. (ESP)   | DOMINGUEZ MILAN A. (ESP) |
| DOMINGUEZ MILAN A. (ESP) |                          |

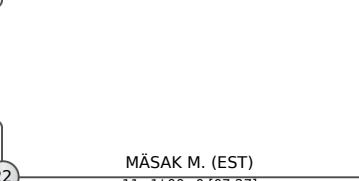
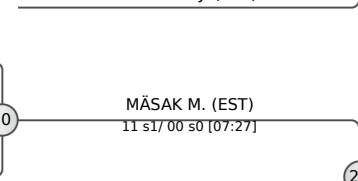
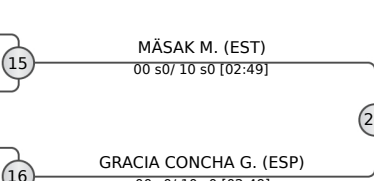
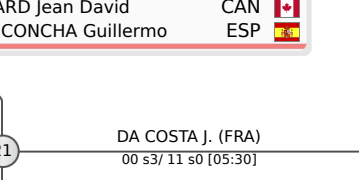
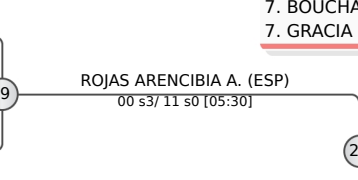
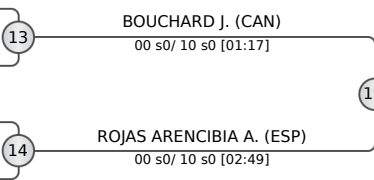





# Fuengirola Cadet European Cup 2023

Spain, Fuengirola, 18-19 Feb 2023

**-40 kg**  
Cadets (5)

| Num. | Competitor           | State  | 1 | 3 | 5 | Wins | Points |
|------|----------------------|--------|---|---|---|------|--------|
| 1.   | CIAVURRO Rachele     | Italy  |   |   |   | 0    | 0      |
| 3.   | AUREL Mathilde       | France |   |   |   | 2    | 0      |
| 5.   | SERRANO GEMES Estela | Spain  |   |   |   | 2    | 0      |

| Num. | Competitor             | State    | 2 | 4 | Wins | Points |
|------|------------------------|----------|---|---|------|--------|
| 2.   | CARINHAS Beatriz       | Portugal |   |   | 0    | 0      |
| 4.   | MARTIN CARRICHES Aiora | Spain    |   |   | 2    | 0      |

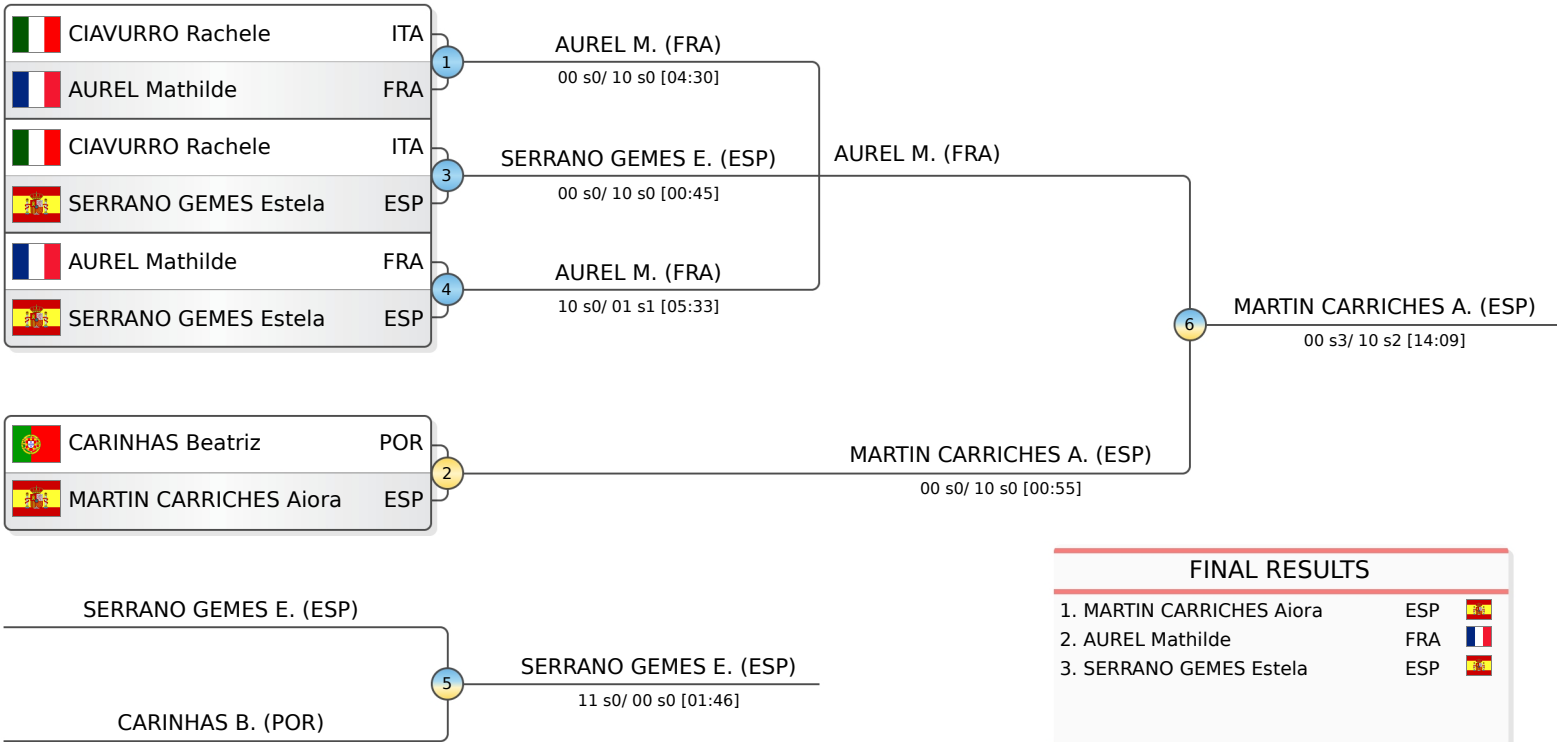

| FINAL RESULTS |                        |     |
|---------------|------------------------|-----|
| 1.            | MARTIN CARRICHES Aiora | ESP |
| 2.            | AUREL Mathilde         | FRA |
| 3.            | SERRANO GEMES Estela   | ESP |



# Fuengirola Cadet European Cup 2023

Spain, Fuengirola, 18-19 Feb 2023

**-44 kg**  
Cadets (18)

**POOL A**

|   |                      |     |
|---|----------------------|-----|
| 1 | BEORLEGUI OSES Marta | ESP |
| 2 | SANCHO Madalena      | POR |
| 3 | REVELLI Alice        | ITA |
| 4 | SANZ NAVARRO Abril   | ESP |
| 4 | RIKMANSPOEL Maud     | NED |

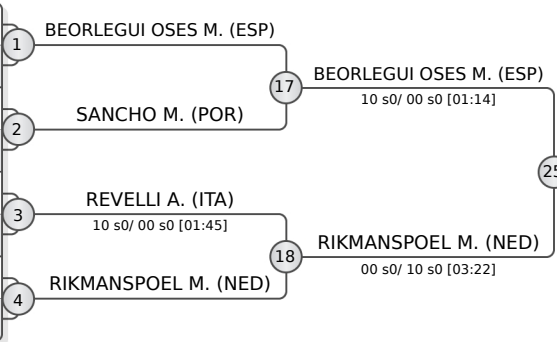

**POOL B**

|   |                      |     |
|---|----------------------|-----|
| 5 | LAHRIFI Lalla-Dounia | FRA |
| 6 | EWING Eva            | GBR |
| 7 | LIMA Imane           | FRA |
| 8 | MOLINA OLIVER Laura  | ESP |

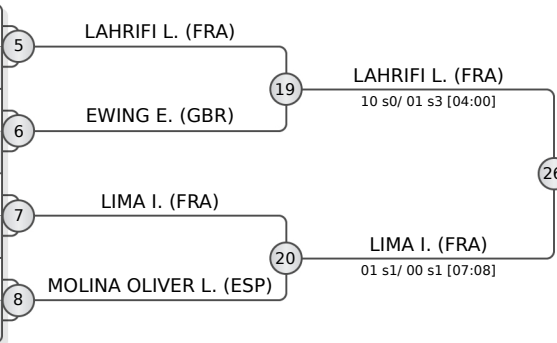

**POOL C**

|    |                        |     |
|----|------------------------|-----|
| 9  | SALVADORI Sara         | ITA |
| 10 | LOPEZ Alice            | FRA |
| 11 | VONDRAKOVA Lada        | CZE |
| 12 | CHURCH Evie            | GBR |
| 12 | GUERRERO FUENTES Angie | ESP |

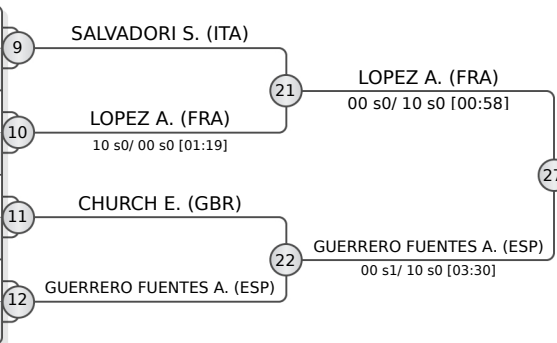

**POOL D**

|    |                       |     |
|----|-----------------------|-----|
| 13 | KRIZOVA Kristina Lili | SVK |
| 14 | GARCIA SANCHEZ Irene  | ESP |
| 15 | PUENTE LOPEZ Africa   | ESP |
| 16 | MORUZZI Rachele       | ITA |

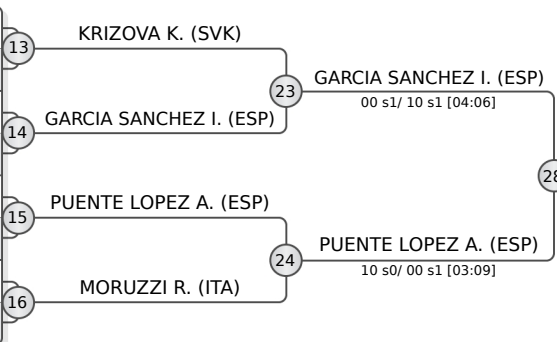

**REPECHAGE**

|    |                     |
|----|---------------------|
| 29 | SANCHO M. (POR)     |
| 30 | EWING E. (GBR)      |
| 31 | VONDRAKOVA L. (CZE) |
| 32 | KRIZOVA K. (SVK)    |

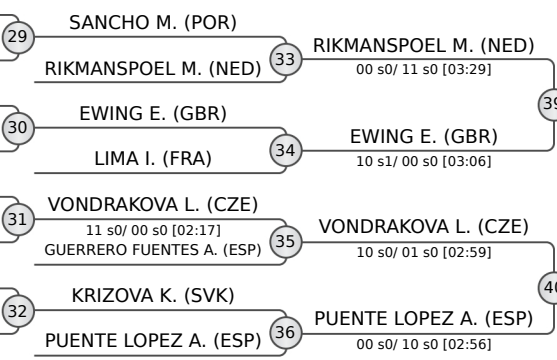

| FINAL RESULTS |                      |     |
|---------------|----------------------|-----|
| 1.            | BEORLEGUI OSES Marta | ESP |
| 2.            | LOPEZ Alice          | FRA |
| 3.            | GARCIA SANCHEZ Irene | ESP |
| 3.            | PUENTE LOPEZ Africa  | ESP |
| 5.            | RIKMANSPOEL Maud     | NED |
| 5.            | LAHRIFI Lalla-Dounia | FRA |
| 7.            | VONDRAKOVA Lada      | CZE |
| 7.            | EWING Eva            | GBR |

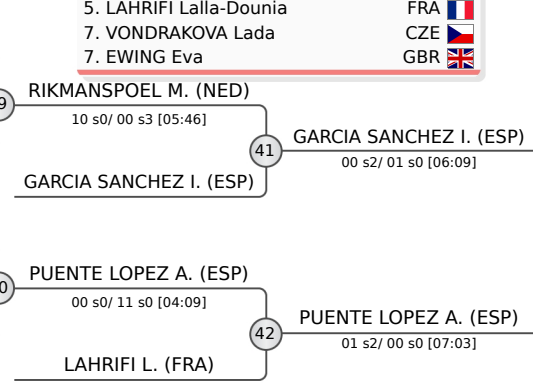



# Fuengirola Cadet European Cup 2023

Spain, Fuengirola, 18-19 Feb 2023

**-48 kg**  
Cadets (23)

**POOL A**

|  |                       |     |
|--|-----------------------|-----|
|  | DIAZ HERNANDEZ Aitana | ESP |
|  | ALDER Amelia          | GBR |
|  | BONZANO Giulia        | ITA |
|  | ALMEIDA Beatriz       | POR |
|  | SABAN Chloe           | FRA |
|  | LIMON TAMARGO Andrea  | ESP |

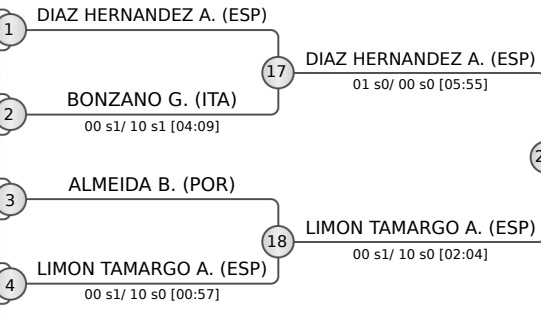

**POOL B**

|  |                      |     |
|--|----------------------|-----|
|  | AYMARD Tifenn        | FRA |
|  | BARRIO PABLO Clara   | ESP |
|  | OBERHUBER Anna       | ITA |
|  | GAITERO MARTIN Marta | ESP |
|  | STOFBERG Lara        | NED |
|  | LAVRINJOVA Marija    | EST |

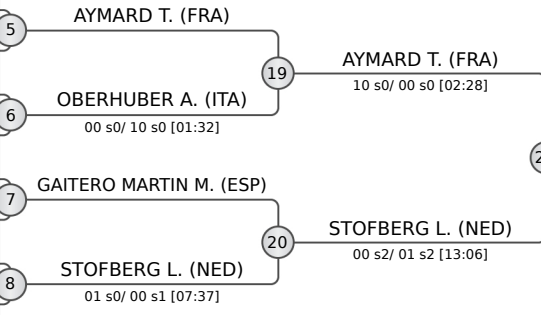

**POOL C**

|  |                                       |     |
|--|---------------------------------------|-----|
|  | BERSELLINI Alice                      | ITA |
|  | BERNARDINO Maria                      | POR |
|  | DYE Isciane                           | FRA |
|  | MURILLO MARTINEZ DE LIZARRONDO Arrate | ESP |
|  | CALLAGHAN Jocelyn                     | GBR |

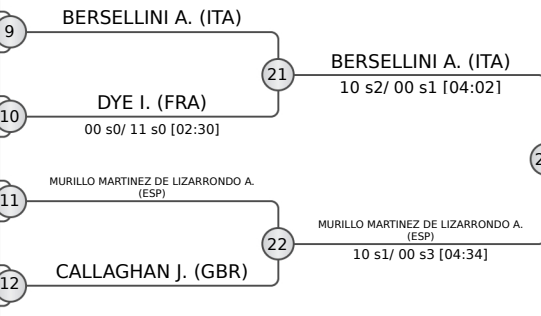

**POOL D**

|  |                                       |     |
|--|---------------------------------------|-----|
|  | CABALLERO Sarah                       | FRA |
|  | DELANEY Ruby                          | GBR |
|  | PLA BELMONTE Claudia                  | ESP |
|  | MAILLARD Celia                        | FRA |
|  | HENRIQUES Iara                        | POR |
|  | FERNANDEZ-VILLARRENAGA FERNANDEZ Ines | ESP |

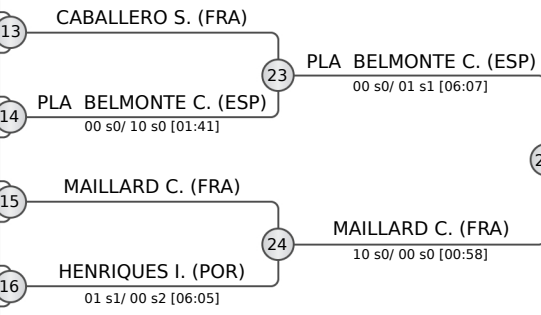

**REPECHAGE**

|                    |    |                    |    |
|--------------------|----|--------------------|----|
| BONZANO G. (ITA)   | 29 | BONZANO G. (ITA)   | 33 |
| OBERHUBER A. (ITA) | 30 | OBERHUBER A. (ITA) | 34 |
| DYE I. (FRA)       | 31 | DYE I. (FRA)       | 35 |
| HENRIQUES I. (POR) | 32 | HENRIQUES I. (POR) | 36 |

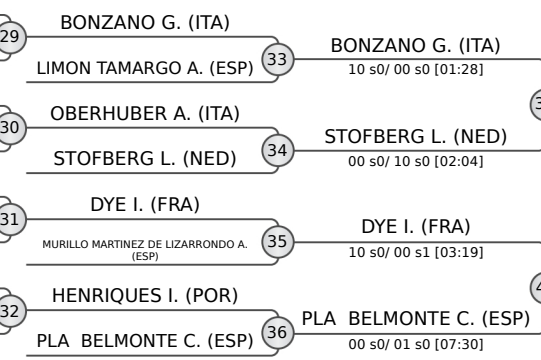

| FINAL RESULTS |                       |     |
|---------------|-----------------------|-----|
| 1.            | DIAZ HERNANDEZ Aitana | ESP |
| 2.            | BERSELLINI Alice      | ITA |
| 3.            | MAILLARD Celia        | FRA |
| 3.            | AYMARD Tifenn         | FRA |
| 5.            | STOFBERG Lara         | NED |
| 5.            | PLA BELMONTE Claudia  | ESP |
| 7.            | DYE Isciane           | FRA |
| 7.            | BONZANO Giulia        | ITA |





# Fuengirola Cadet European Cup 2023

Spain, Fuengirola, 18-19 Feb 2023

**-52 kg**  
Cadets (34)

**POOL A**

|                                      |     |   |
|--------------------------------------|-----|---|
| TERBISH Ariunzaya                    | MGL | 1 |
| MARTINEZ DE RITUERTO MORILLAS Monica | ESP | 2 |
| SCHROEDER Anna                       | EST | 3 |
| BERRIOT Eilys                        | FRA | 4 |
| HODSON Lola                          | GBR | 5 |
| AGATI-ALOUACHE Manon                 | FRA | 6 |
| BLANCO ARMENTEROS Laura              | ESP | 7 |
| SANTOS Sofia                         | POR | 8 |

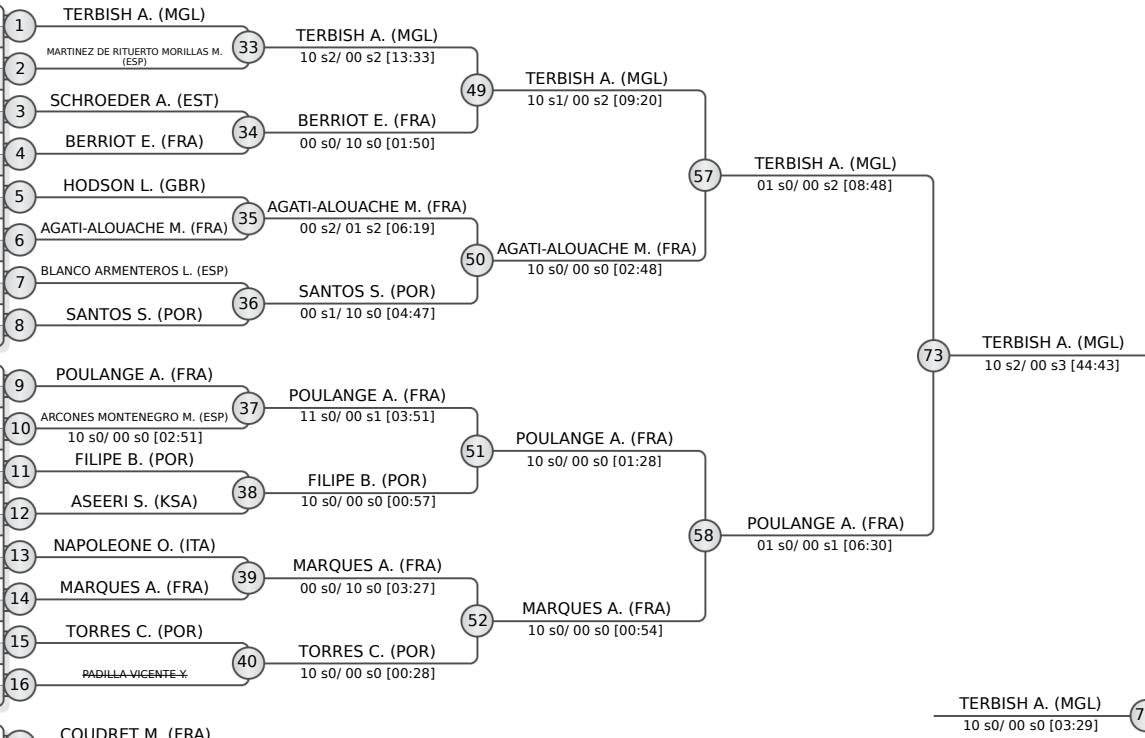

**POOL B**

|                                    |     |    |
|------------------------------------|-----|----|
| POULANGE Alyssia                   | FRA | 9  |
| ARCONES MONTENEGRO Maria Del Rocio | ESP | 10 |
| EINIKAITE Vytaute                  | LTU | 11 |
| FILIPE Beatriz                     | POR | 12 |
| ASEERI Sara Sattam S               | KSA | 13 |
| NAPOLEONE Ottavia                  | ITA | 14 |
| MARQUES Alicia                     | FRA | 15 |
| TORRES Catarina                    | POR | 16 |
| PADILLA VICENTE Yesenia            | ESP | 17 |

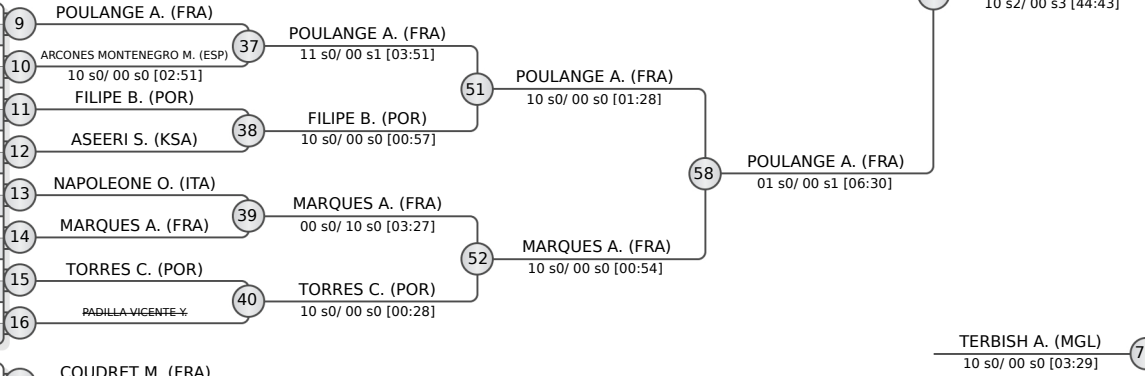

**POOL C**

|                    |     |    |
|--------------------|-----|----|
| COUDRET Mathilde   | FRA | 17 |
| TRINDADE Margarida | POR | 18 |
| GIL SAEZ Maria     | ESP | 19 |
| CHISHOLM Kate      | GBR | 20 |
| SCHIPPER Yael      | NED | 21 |
| DUSSAULT Leanne    | CAN | 22 |
| FLEURY Calypso     | FRA | 23 |
| SAEZ HEVIA Adriana | ESP | 24 |

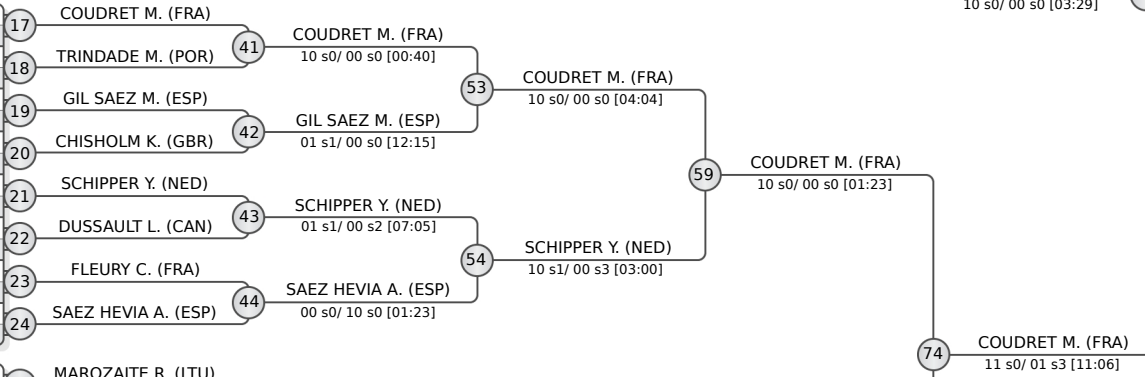

**POOL D**

|                        |     |    |
|------------------------|-----|----|
| MAROZAITTE Rugile      | LTU | 25 |
| CABRAL Raquel          | POR | 26 |
| ROBINSON Lucy          | GBR | 27 |
| RIVERO SUAREZ Daniela  | ESP | 28 |
| COMEYNE Manon          | FRA | 29 |
| PERRA Arianna Carlotta | ITA | 30 |
| DOUIDI Lina            | FRA | 31 |
| PEREIRA Mariana        | POR | 32 |
| VIVES PUEYO Martina    | ESP | 33 |

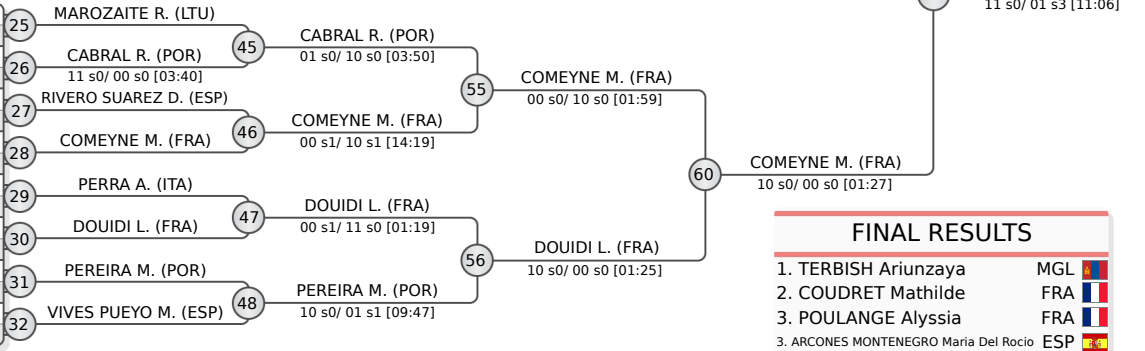

| FINAL RESULTS |                                    |     |
|---------------|------------------------------------|-----|
| 1.            | TERBISH Ariunzaya                  | MGL |
| 2.            | COUDRET Mathilde                   | FRA |
| 3.            | POULANGE Alyssia                   | FRA |
| 3.            | ARCONES MONTENEGRO Maria Del Rocio | ESP |
| 5.            | RIVERO SUAREZ Daniela              | ESP |
| 5.            | COMEYNE Manon                      | FRA |
| 7.            | SCHIPPER Yael                      | NED |
| 7.            | AGATI-ALOUACHE Manon               | FRA |

**REPECHAGE**

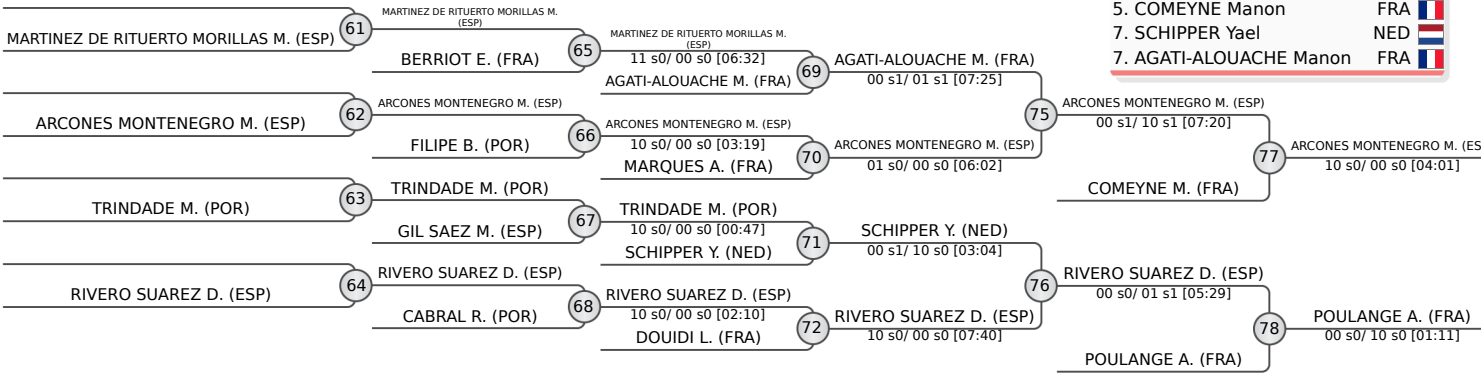



# Fuengirola Cadet European Cup 2023

Spain, Fuengirola, 18-19 Feb 2023

**-57 kg**  
Cadets (29)

**POOL A**

|  |                            |     |
|--|----------------------------|-----|
|  | SILVEIRA Maria             | POR |
|  | LAFAY Maelys               | FRA |
|  | VAZQUEZ FERNANDEZ Irene    | ESP |
|  | SINNEMA Fleur              | NED |
|  | GEV Shira                  | ISR |
|  | LYSOGOR CHERKESOVA Natalia | ESP |
|  | IDDIR Feroudja             | FRA |

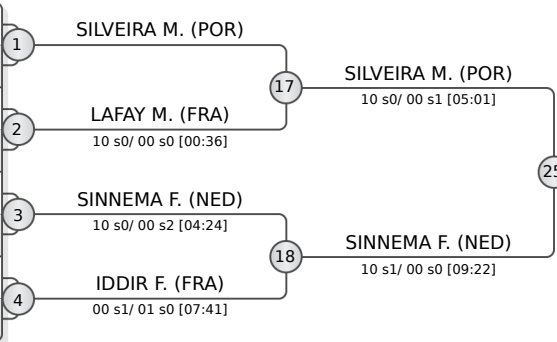

**POOL B**

|  |                       |     |
|--|-----------------------|-----|
|  | MYLLYLA Riina         | FIN |
|  | MARTIN GIL Aitana     | ESP |
|  | CESLAUSKAITE Deimante | LTU |
|  | FROSONI Giorgia       | ITA |
|  | PILLOT Emma           | FRA |
|  | ALMEIDA Diana         | POR |
|  | PAZOS TRILLO Lucia    | ESP |
|  | KISSENISKY Maddy      | GBR |

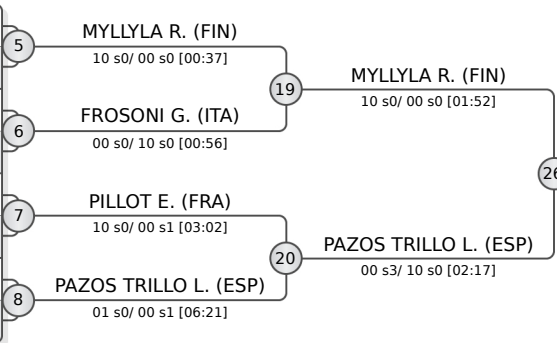

**POOL C**

|  |                        |     |
|--|------------------------|-----|
|  | LINK Chloe             | GBR |
|  | TORRES IBARCENA Isabel | ESP |
|  | SKERYTE Ugne           | LTU |
|  | NKAYILU Armynda        | FRA |
|  | SEIKKULA Pihla-Maria   | FIN |
|  | SUAREZ GARCIA Adriana  | ESP |
|  | DIAS Maria             | POR |

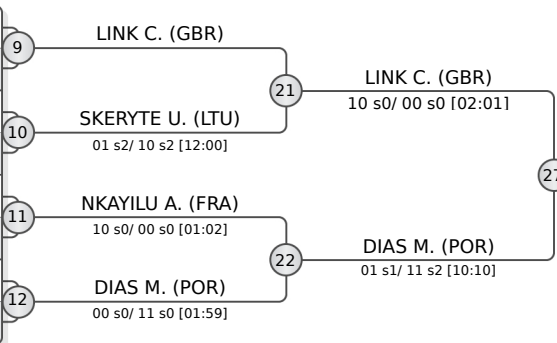

**POOL D**

|  |                          |     |
|--|--------------------------|-----|
|  | RAINE Kenady             | GBR |
|  | DES COGNETS-JULIE Lou    | FRA |
|  | MORALES ROSIQUE Claudia  | ESP |
|  | NICOLAS Ielena           | FRA |
|  | KUCHARZ Maja             | POL |
|  | MORALES IMBERNON Claudia | ESP |
|  | GAMBARDELLA Nina         | ITA |

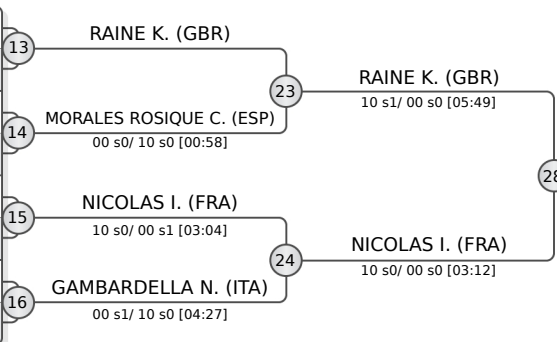

**REPECHAGE**

|                      |    |                       |    |                       |
|----------------------|----|-----------------------|----|-----------------------|
| LAFAY M. (FRA)       | 29 | LAFAY M. (FRA)        | 33 | SINNEMA F. (NED)      |
| MARTIN GIL A. (ESP)  |    | SINNEMA F. (NED)      |    | 00 s0/ 01 s1 [10:02]  |
| FROSONI G. (ITA)     | 30 | FROSONI G. (ITA)      | 34 | PAZOS TRILLO L. (ESP) |
|                      |    | PAZOS TRILLO L. (ESP) |    | 00 s0/ 10 s0 [01:20]  |
| SKERYTE U. (LTU)     | 31 | SKERYTE U. (LTU)      | 35 | SKERYTE U. (LTU)      |
| KUCHARZ M. (POL)     |    | DIAS M. (POR)         |    | 10 s1/ 01 s2 [09:40]  |
| GAMBARDELLA N. (ITA) | 32 | GAMBARDELLA N. (ITA)  | 36 | GAMBARDELLA N. (ITA)  |
|                      |    | RAINE K. (GBR)        |    | 11 s0/ 01 s1 [08:46]  |

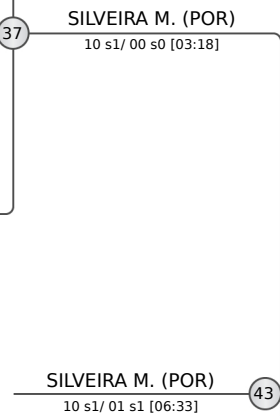
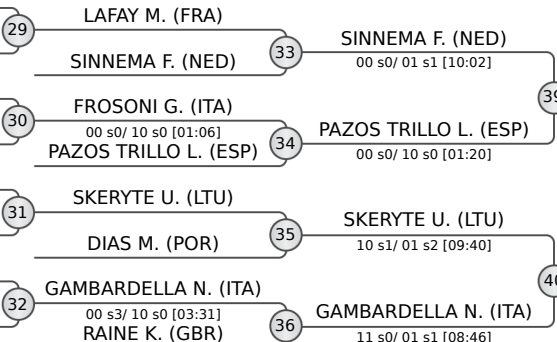

| FINAL RESULTS |                        |
|---------------|------------------------|
| 1.            | SILVEIRA Maria POR     |
| 2.            | LINK Chloe GBR         |
| 3.            | SKERYTE Ugne LTU       |
| 3.            | NICOLAS Ielena FRA     |
| 5.            | MYLLYLA Riina FIN      |
| 5.            | SINNEMA Fleur NED      |
| 7.            | PAZOS TRILLO Lucia ESP |
| 7.            | GAMBARDELLA Nina ITA   |





# Fuengirola Cadet European Cup 2023

Spain, Fuengirola, 18-19 Feb 2023

**-63 kg**  
Cadets (34)

**POOL A**

|   |                               |     |
|---|-------------------------------|-----|
| 1 | SIMUNKOVA Adela               | CZE |
| 2 | LIPPUS Henrietta              | EST |
| 3 | WINDLE Lucy                   | GBR |
| 4 | BOJ CHAVEZ Tamara             | ESP |
| 5 | CHIPAN Jaelynn                | FRA |
| 6 | YERMIAHU Mai                  | ISR |
| 7 | OBOJES Laura                  | ITA |
| 8 | RODRIGUEZ GONZALEZ Nira Maria | ESP |

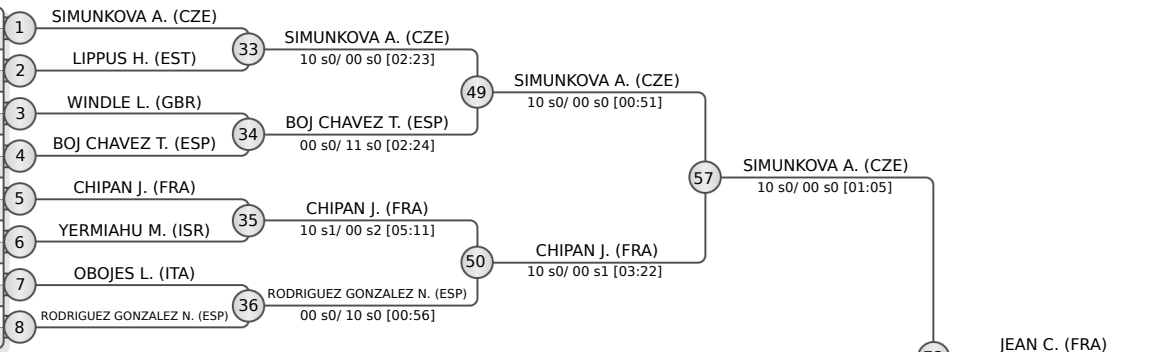

**POOL B**

|    |                                       |     |
|----|---------------------------------------|-----|
| 9  | MARTINEZ DE RITUERTO MORILLAS Beatriz | ESP |
| 10 | VAN DER MAAS Kim                      | NED |
| 11 | JEAN Chloé                            | FRA |
| 12 | RADOSAVOVIC Kristina                  | MNE |
| 13 | VAZQUEZ SEIJAS Uxia                   | ESP |
| 14 | MCMILLAN Sophie                       | GBR |
| 15 | DE PARMA LEON Luca                    | ESP |
| 16 | COSTA Leonor                          | POR |
| 17 | POATY Beyhane                         | FRA |

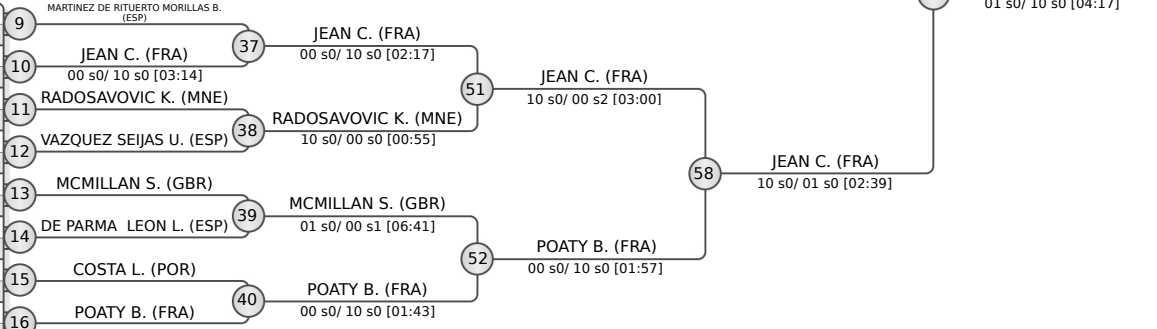

**POOL C**

|    |                                |     |
|----|--------------------------------|-----|
| 17 | KUCHAR Varvara                 | LTU |
| 18 | PINA Carlota                   | POR |
| 19 | PALAGI Valentina               | ITA |
| 20 | VILLAMEDIANA JUNCAL Leyre      | ESP |
| 21 | KHURELCHULUUN Maralma          | MGL |
| 22 | HREBENYK SAVCHAK Olena Suzanna | ESP |
| 23 | ANTON Roberta                  | GBR |
| 24 | ASTIER Ema                     | FRA |

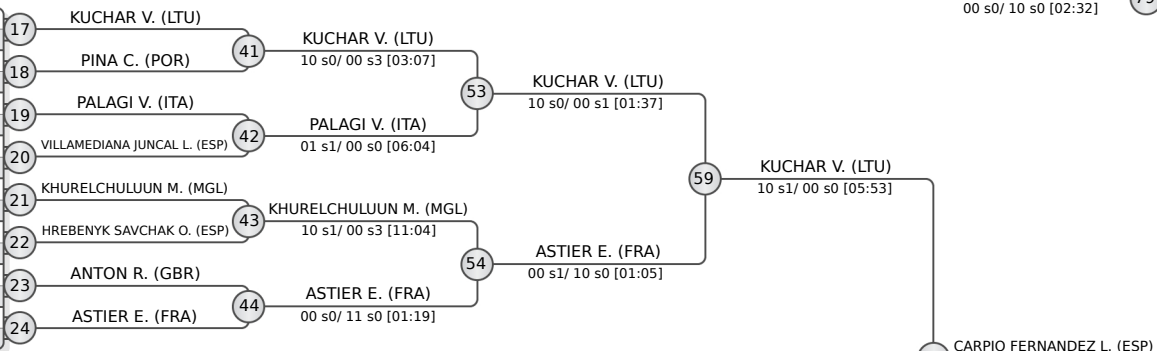

**POOL D**

|    |                           |     |
|----|---------------------------|-----|
| 25 | GLUBIAK Magda             | POL |
| 26 | NARVA Ada-Alexia          | FIN |
| 27 | ESCASO HURTADO Visitacion | ESP |
| 28 | CARPIO FERNANDEZ Lucia    | ESP |
| 29 | AUBERT GOMEZ Maya         | GBR |
| 30 | SANZANA Dakota            | CAN |
| 31 | JOTA Matilde              | POR |
| 32 | NAVAL-MARQUES-Sandra      | ESP |
| 33 | GIRARD-POMBIELH Margot    | FRA |

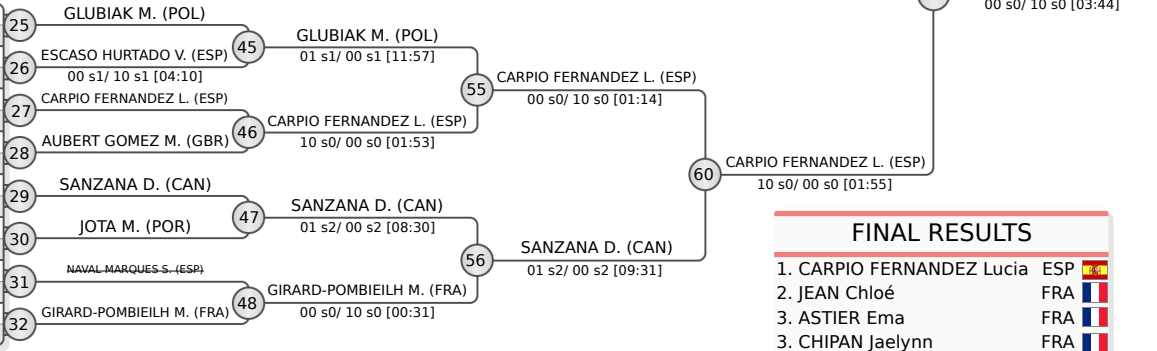

| FINAL RESULTS |                        |     |
|---------------|------------------------|-----|
| 1.            | CARPIO FERNANDEZ Lucia | ESP |
| 2.            | JEAN Chloé             | FRA |
| 3.            | ASTIER Ema             | FRA |
| 3.            | CHIPAN Jaelynn         | FRA |
| 5.            | SIMUNKOVA Adela        | CZE |
| 5.            | KUCHAR Varvara         | LTU |
| 7.            | POATY Beyhane          | FRA |
| 7.            | AUBERT GOMEZ Maya      | GBR |

**REPECHAGE**

|    |                                        |
|----|----------------------------------------|
| 61 | LIPPUS H. (EST)                        |
| 62 | MARTINEZ DE RITUERTO MORILLAS B. (ESP) |
| 63 | PINA C. (POR)                          |
| 64 | AUBERT GOMEZ M. (GBR)                  |

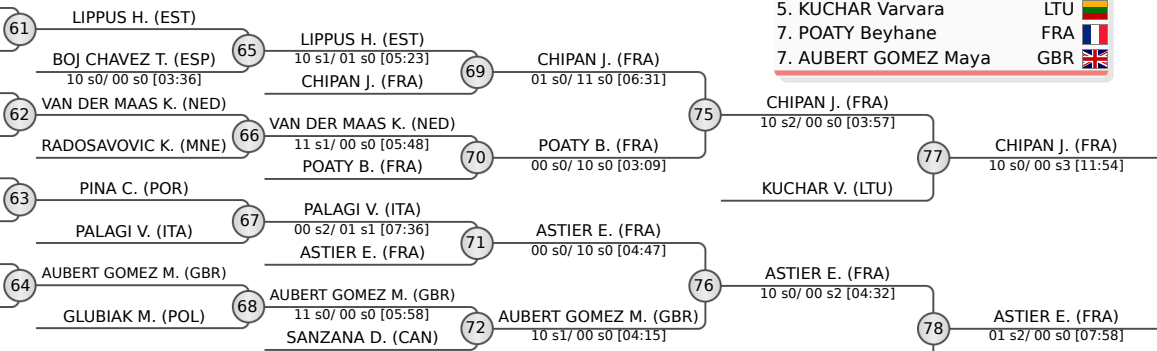



# Fuengirola Cadet European Cup 2023

Spain, Fuengirola, 18-19 Feb 2023

**-70 kg**  
Cadets (22)

**POOL A**

|  |                           |     |
|--|---------------------------|-----|
|  | HOJDAROVA Stepanka        | CZE |
|  | DAMOC Denisa Francesca    | ITA |
|  | NLEMBE Lou Cecile         | FRA |
|  | JACOBS Kiki               | NED |
|  | AYENSA GARCIA Maria Pilar | ESP |

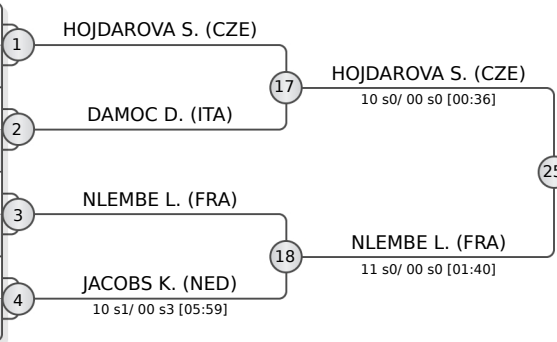

**POOL B**

|  |                    |     |
|--|--------------------|-----|
|  | MUTEBA Nina        | FRA |
|  | STALIONYTE Paulina | LTU |
|  | QUEIROS Ana        | POR |
|  | MENGIA Aurora      | ITA |
|  | CLOTEAUX Manon     | FRA |
|  | CALDERON LUNA Mar  | ESP |

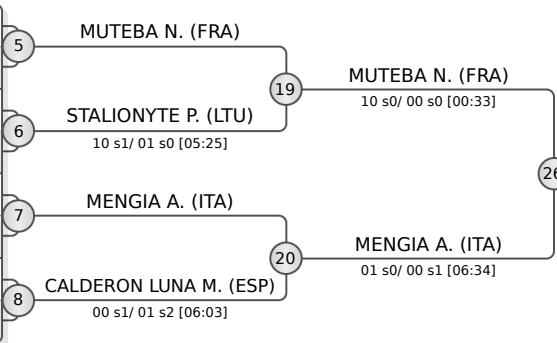

**POOL C**

|  |                   |     |
|--|-------------------|-----|
|  | MARCZAK Julia     | GBR |
|  | DIAS Patricia     | POR |
|  | PEREZ MUR Candela | ESP |
|  | RULLIER Lucie     | FRA |
|  | NOVIKOVAITE Saule | LTU |

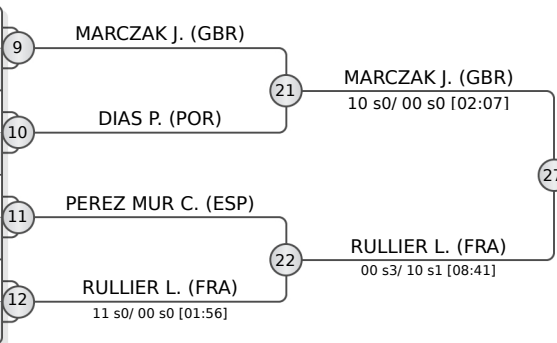

**POOL D**

|  |                      |     |
|--|----------------------|-----|
|  | NAVICKAITE Marta     | LTU |
|  | TRONGONE Francesca   | ITA |
|  | SACKO Nene           | FRA |
|  | VAN LIJF Xanne       | NED |
|  | LETON ESCUDERO Karla | ESP |
|  | ROSA Beatriz         | POR |

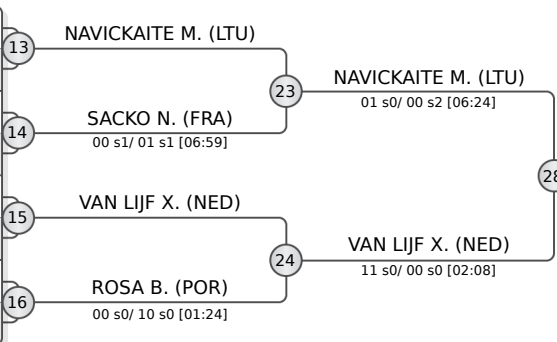

**REPECHAGE**

|                     |    |                 |    |
|---------------------|----|-----------------|----|
| JACOBS K. (NED)     | 29 | JACOBS K. (NED) | 33 |
| STALIONYTE P. (LTU) | 30 | MENGIA A. (ITA) | 34 |
| DIAS P. (POR)       | 31 | DIAS P. (POR)   | 35 |
| ROSA B. (POR)       | 32 | ROSA B. (POR)   | 40 |

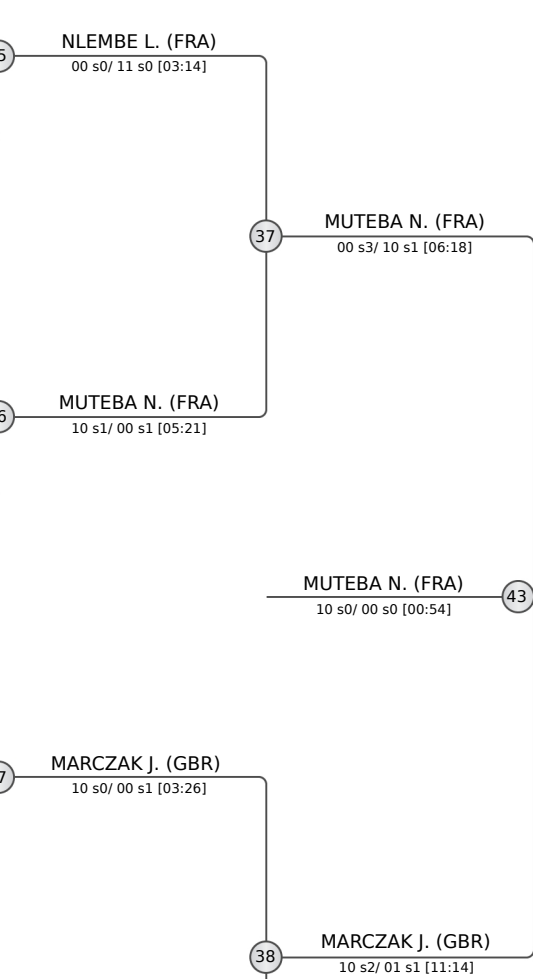
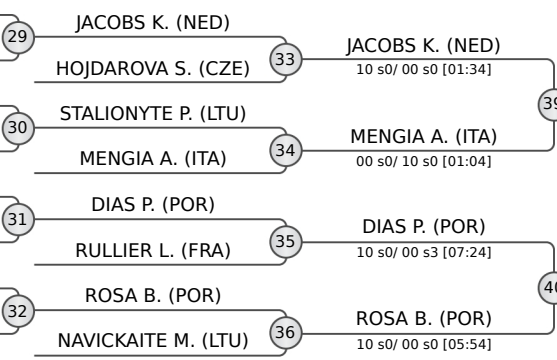

| FINAL RESULTS |                       |
|---------------|-----------------------|
| 1.            | MUTEBA Nina FRA       |
| 2.            | MARCZAK Julia GBR     |
| 3.            | NLEMBE Lou Cecile FRA |
| 3.            | MENGIA Aurora ITA     |
| 5.            | DIAS Patricia POR     |
| 5.            | VAN LIJF Xanne NED    |
| 7.            | JACOBS Kiki NED       |
| 7.            | ROSA Beatriz POR      |





# Fuengirola Cadet European Cup 2023

Spain, Fuengirola, 18-19 Feb 2023

**+ 70 kg**  
Cadets (14)

**POOL A**

|  |                                  |     |
|--|----------------------------------|-----|
|  | MINKADA-CAQUINEAU Leonie         | FRA |
|  | GOYTIA CHAJTUR Ariadna Alejandra | ESP |
|  | POGOSYAN Gayane                  | EST |

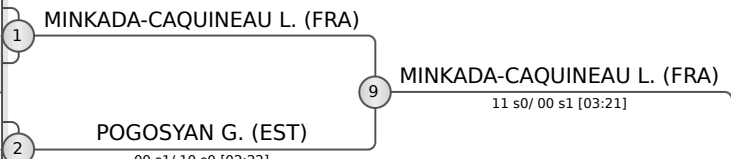

**POOL B**

|  |                         |     |
|--|-------------------------|-----|
|  | KOSNAROVA Marie         | CZE |
|  | MARIN Alejandra Beatriz | ESP |
|  | TCHUMAMO Emeraude       | FRA |
|  | HANHELA Laura           | FIN |

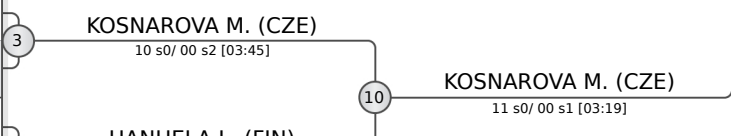

**POOL C**

|  |                  |     |
|--|------------------|-----|
|  | SALA CANO Aitana | ESP |
|  | AFRIT Rose       | FRA |
|  | MANE Rosa        | POR |

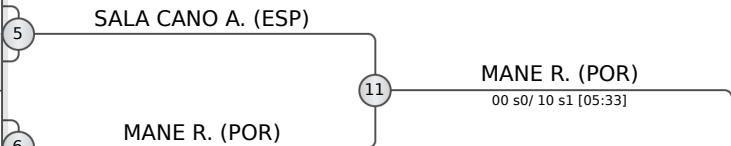

**POOL D**

|  |                                |     |
|--|--------------------------------|-----|
|  | AKTAS Emma-Melis               | EST |
|  | CHINI Chiara                   | FRA |
|  | DIANKOLELA-BINIAKOUNOU Quessia | FRA |
|  | KASZPEROVA Kristyna            | CZE |

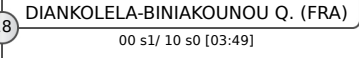
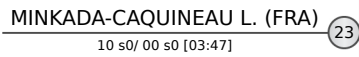
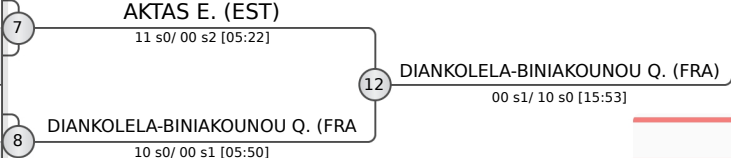

| FINAL RESULTS |                                |     |
|---------------|--------------------------------|-----|
| 1.            | MINKADA-CAQUINEAU Leonie       | FRA |
| 2.            | DIANKOLELA-BINIAKOUNOU Quessia | FRA |
| 3.            | MANE Rosa                      | POR |
| 3.            | KOSNAROVA Marie                | CZE |
| 5.            | HANHELA Laura                  | FIN |
| 5.            | AKTAS Emma-Melis               | EST |
| 7.            | POGOSYAN Gayane                | EST |
| 7.            | SALA CANO Aitana               | ESP |

**REPECHAGE**

