



Poznan Junior European Cup 2023

Poland, Poznan, 15-16 Apr 2023

-60 kg

Juniors (41)

POOL A

1	VISOV N. (UKR)	33	VISOV N. (UKR)
2	CAKIR A. (TUR)	10 s0/00 s1 [02:39]	01 s0/00 s0 [04:00]
3	BOECKER F. (GER)	34	BOECKER F. (GER)
4	CHATONNET M. (FRA)	02 s1/00 s0 [01:45]	49
5	ELION GAMBOU R. (FRA)	35	ELION GAMBOU R. (FRA)
6	SHAI O. (ISR)	00 s0/10 s2 [04:43]	10 s0/00 s1 [03:26]
7	WITTEVEEN T. (NED)	36	RAQUET L. (BEL)
8	RAQUET L. (BEL)	00 s2/02 s0 [03:13]	10 s0/00 s3 [01:41]

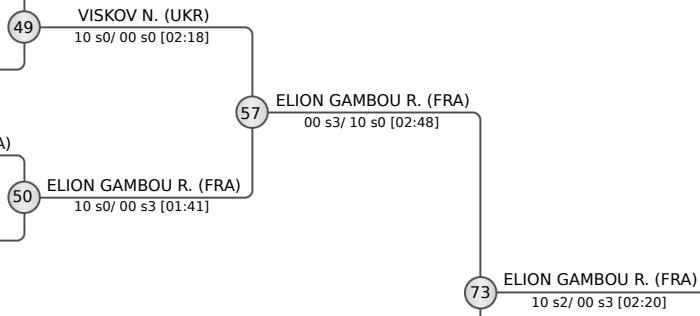

POOL B

9	SAMPINO F. (ITA)	37	IMRANOV N. (AZE)
10	IMRANOV N. (AZE)	00 s3/10 s1 [05:50]	00 s2/01 s1 [04:00]
11	HADJISAVVAS G. (CYP)	38	DEGHNOUCHE I. (FRA)
12	DEGHNOUCHE I. (FRA)	00 s0/10 s0 [01:34]	51
13	MERDIN E. (BEL)	39	MERDIN E. (BEL)
14	MICHNA K. (POL)	10 s0/00 s0 [01:18]	39
15	VELSTRA S. (NED)	00 s2/10 s0 [04:44]	40
16	EBERHARDT P. (FRA)	02 s1/00 s1 [03:46]	52

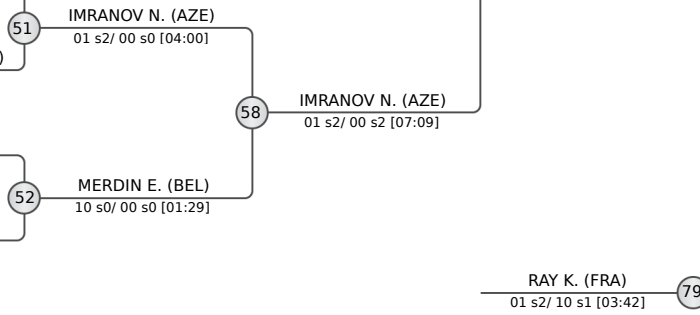

POOL C

17	AVERSA S. (ITA)	41	AVERSA S. (ITA)
18	MURADLI M. (AZE)	10 s0/00 s3 [03:11]	53
19	ESENBOGA Y. (TUR)	01 s0/00 s2 [04:00]	42
20	SAOUD A. (FRA)	00 s2/11 s0 [03:47]	54
21	RAY K. (FRA)	43	RAY K. (FRA)
22	BIEDRZYCKI H. (POL)	10 s1/00 s2 [03:09]	54
23	JELIC ARENAZA A. (ITA)	00 s1/01 s0 [04:00]	44
24	HARTGRING P. (NED)	10 s0/00 s0 [01:44]	44

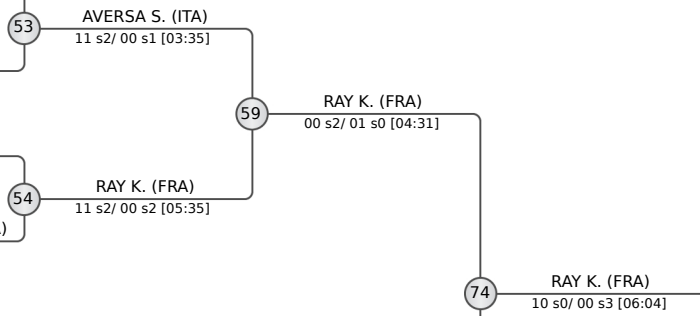

POOL D

25	ANDREINI P. (ITA)	45	ANDREINI P. (ITA)
26	PIECHOTA S. (POL)	01 s0/02 s1 [02:06]	55
27	REBEYROL M. (FRA)	46	AYDIN B. (TUR)
28	AYDIN B. (TUR)	00 s0/10 s0 [01:03]	56
29	HORBAN A. (UKR)	47	DEMARINIS T. (FRA)
30	DEMARINIS T. (FRA)	00 s3/10 s0 [02:11]	56
31	KARIMLI N. (AZE)	01 s2/00 s1 [04:00]	48
32	MAAS M. (NED)	11 s0/01 s1 [02:34]	48

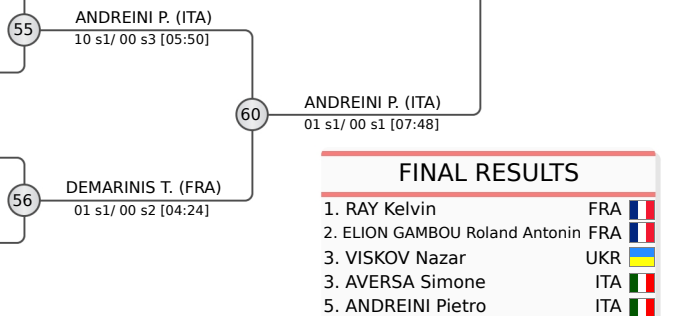

REPECHAGE

61	SHAI O. (ISR)	65	SHAI O. (ISR)
62	IGNACZAK M. (FRA)	66	IGNACZAK M. (FRA)
63	BIEDRZYCKI H. (POL)	67	JELIC ARENAZA A. (ITA)
64	PIECHOTA S. (POL)	68	AYDIN B. (TUR)

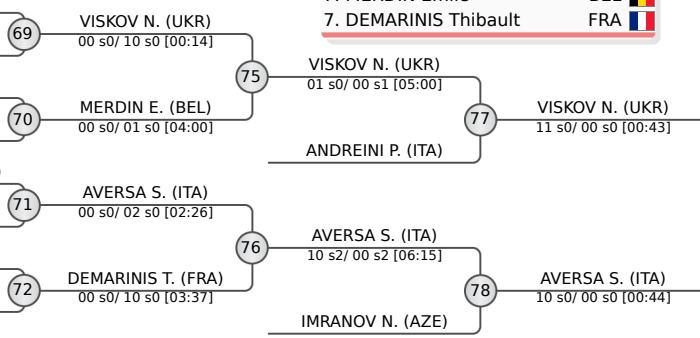

FINAL RESULTS

- RAY Kelvin (FRA)
- ELION GAMBOU Roland Antonin (FRA)
- VISOV Nazar (UKR)
- AVERSA Simone (ITA)
- ANDREINI Pietro (ITA)
- IMRANOV Nizami (AZE)
- MERDIN Emile (BEL)
- DEMARINIS Thibault (FRA)





Poznan Junior European Cup 2023

Poland, Poznan, 15-16 Apr 2023

-66 kg

Juniors (48)

POOL A

1	ACCOGLI Valerio	ITA
2	CAKAN Enes	TUR
3	NAGHIYEV Nijat	AZE
4	KORVAL Meane	FRA
5	ZDANOWSKI Eryk	POL
6	VARMUZKA Matej	CZE
7	VAN HARTEN Jochem	NED
8	LANTUSHENKO Klym	UKR
9	KALAITSIDIS Georgios	CYP
10	KOTLIK Marcin	POL
11	NIEMENKARI Kasper	FIN
12	CADIGNAN Nathan	FRA

1	ACCOGLI V. (ITA)	33	NAGHIYEV N. (AZE)
2	NAGHIYEV N. (AZE)	00 s1/ 01 s1 [04:00]	00 s1/ 10 s0 [03:31]
3	KORVAL M. (FRA)	34	KORVAL M. (FRA)
4	VARMUZKA M. (CZE)	11 s0/ 00 s0 [00:43]	
5	VAN HARTEN J. (NED)	35	LANTUSHENKO K. (UKR)
6	LANTUSHENKO K. (UKR)	01 s2/ 00 s0 [04:00]	00 s3/ 11 s1 [03:58]
7	NIEMENKARI K. (FIN)	36	NIEMENKARI K. (FIN)
8	CADIGNAN N. (FRA)	10 s0/ 00 s0 [00:06]	

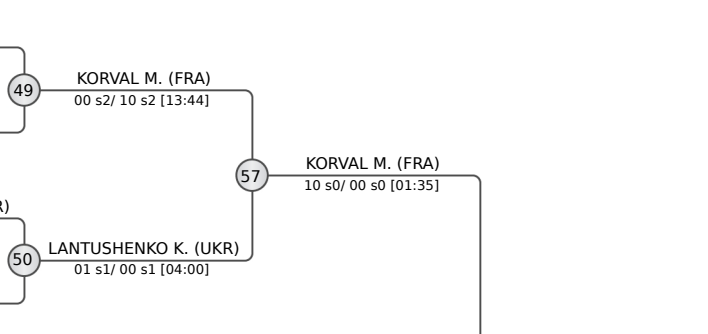

POOL B

9	PIRIYEV Samir	AZE
10	FRANCESCHI Zian	FRA
11	GOLEDZINOWSKI Jakub	POL
12	KHIRI Abdesalem	FRA
13	SZOPA Mikolaj	POL
14	TOKTAY Davut	TUR
15	KRIJTJE Nanco	NED
16	SUHORUKOV Daniils	LAT
17	MARINX Ray	BEL
18	DUBINA Hlib	UKR
19	BOULEMTAFES Dayyan	FRA
20	DERKACZ Marcel	POL

9	PIRIYEV S. (AZE)	37	FRANCESCHI Z. (FRA)
10	FRANCESCHI Z. (FRA)	10 s0/ 00 s0 [03:11]	00 s0/ 10 s0 [01:27]
11	KHIRI A. (FRA)	38	TOKTAY D. (TUR)
12	SZOPA M. (POL)	02 s0/ 00 s0 [01:33]	00 s2/ 02 s1 [02:03]
13	KRIJTJE N. (NED)	39	KRIJTJE N. (NED)
14	MARINX R. (BEL)	00 s0/ 10 s0 [00:20]	01 s0/ 00 s2 [04:14]
15	BOULEMTAFES D. (FRA)	40	BOULEMTAFES D. (FRA)
16	DERKACZ M. (POL)	02 s0/ 00 s0 [00:44]	

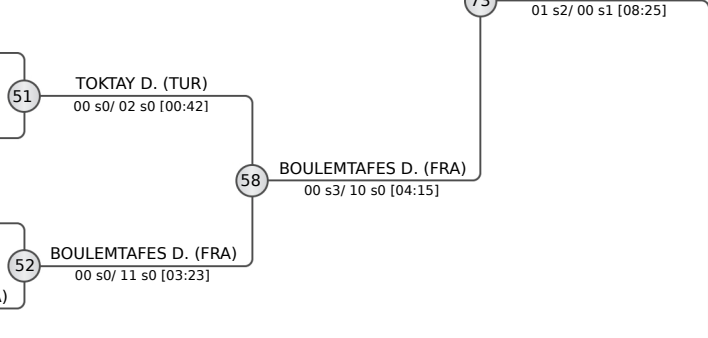

POOL C

17	LIPARD Viljar	EST
18	NORKEVICIUS Matas	LTU
19	RZAYEV Aydin	AZE
20	BOZKURT Ali	TUR
21	RENARD Alexis	FRA
22	KUSTRZYCKI Kamil	POL
23	KLIMKIEWICZ Krzysztof	POL
24	CHANSSEAUME Colin	FRA
25	SIMOENS Xander	BEL
26	NOWOK Oliwier	POL
27	HURSKAINEN Perttu	FIN
28	DUMONT Manoah	FRA

17	LIPARD V. (EST)	41	RZAYEV A. (AZE)
18	RZAYEV A. (AZE)	00 s0/ 10 s0 [00:18]	00 s0/ 02 s0 [01:31]
19	RENARD A. (FRA)	42	RENARD A. (FRA)
20	KUSTRZYCKI K. (POL)	01 s3/ 11 s0 [04:00]	10 s0/ 00 s0 [01:05]
21	KLIMKIEWICZ K. (POL)	43	SIMOENS X. (BEL)
22	SIMOENS X. (BEL)	00 s0/ 02 s1 [03:06]	00 s0/ 10 s0 [02:49]
23	NOWOK O. (POL)	44	DUMONT M. (FRA)
24	HURSKAINEN P. (FIN)	11 s0/ 01 s1 [02:50]	00 s0/ 10 s0 [01:26]

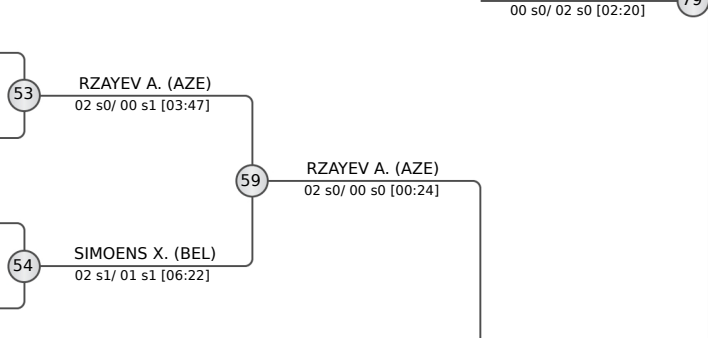

POOL D

25	DEMIREL Ibrahim	TUR
26	IVANOV Kyrylo	UKR
27	NOEL Kylian	FRA
28	BOGDANSKI Teodor	POL
29	DELLO RUSSO Lino Andrea	GER
30	KUJANHAARA Joonatan	FIN
31	WALDSBERGER Tomas	CZE
32	PEC Jakub	POL
33	BAGDASAROV Sevak	FRA
34	FIDAN Caner	TUR
35	BABIRECKI Grzegorz	POL
36	NINFO Federico	ITA

25	DEMIREL I. (TUR)	45	DEMIREL I. (TUR)
26	NOEL K. (FRA)	00 s1/ 02 s1 [01:36]	01 s1/ 00 s1 [04:00]
27	BOGDANSKI T. (POL)	46	DELLO RUSSO L. (GER)
28	DELLO RUSSO L. (GER)	00 s0/ 10 s2 [06:32]	02 s0/ 00 s2 [02:31]
29	KUJANHAARA J. (FIN)	47	WALDSBERGER T. (CZE)
30	WALDSBERGER T. (CZE)	11 s1/ 00 s0 [02:59]	
31	PEC J. (POL)	48	NINFO F. (ITA)
32	BAGDASAROV S. (FRA)	00 s1/ 02 s2 [02:34]	00 s1/ 10 s1 [04:39]

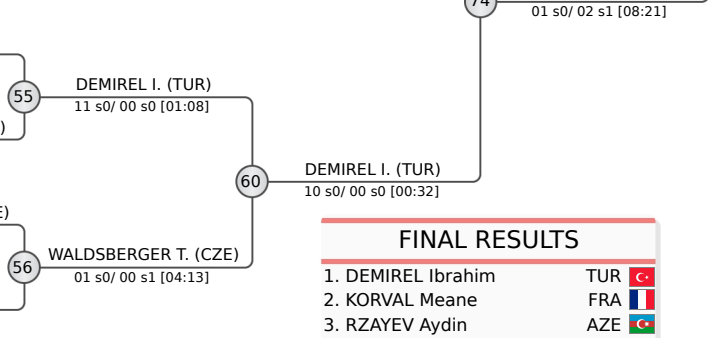

FINAL RESULTS	
1.	DEMIREL Ibrahim (TUR)
2.	KORVAL Meane (FRA)
3.	RZAYEV Aydin (AZE)
3.	SIMOENS Xander (BEL)
5.	NAGHIYEV Nijat (AZE)
5.	BOULEMTAFES Dayyan (FRA)
7.	DUBINA Hlib (UKR)
7.	NOEL Kylian (FRA)

REPECHAGE

61	ZDANOWSKI E. (POL)	65	NAGHIYEV N. (AZE)
62	VARMUZKA M. (CZE)	66	DUBINA H. (UKR)
63	DUBINA H. (UKR)	67	RENARD A. (FRA)
64	DERKACZ M. (POL)	68	DELLO RUSSO L. (GER)
65	NORKEVICIUS M. (LTU)	69	NAGHIYEV N. (AZE)
66	LIPARD V. (EST)	70	DUBINA H. (UKR)
67	LIPARD V. (EST)	71	SIMOENS X. (BEL)
68	NOEL K. (FRA)	72	NOEL K. (FRA)

61	VARMUZKA M. (CZE)	65	NAGHIYEV N. (AZE)
62	DUBINA H. (UKR)	66	DUBINA H. (UKR)
63	LIPARD V. (EST)	67	RENARD A. (FRA)
64	NOEL K. (FRA)	68	DELLO RUSSO L. (GER)
65	NAGHIYEV N. (AZE)	69	NAGHIYEV N. (AZE)
66	DUBINA H. (UKR)	70	DUBINA H. (UKR)
67	RENARD A. (FRA)	71	SIMOENS X. (BEL)
68	DELLO RUSSO L. (GER)	72	NOEL K. (FRA)

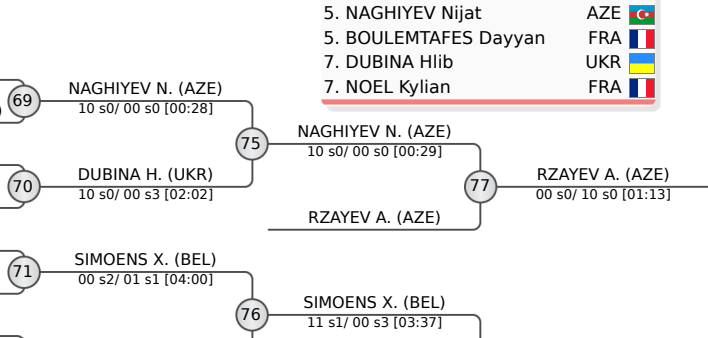



Poznan Junior European Cup 2023

Poland, Poznan, 15-16 Apr 2023

-73 kg

Juniors (41)

POOL A

PELLIGRA Vincenzo	ITA	1	PELLIGRA V. (ITA)
NAGEL Randy	EST	2	NAGEL R. (EST) 33
CHWISTEK Piotr	POL	3	BUYUKESER T. (TUR)
BUYUKESER Talha	TUR	3	00 s1/ 11 s0 [01:06]
PREVE Eliot	FRA	4	PREVE E. (FRA) 34
PREVE E. (FRA)			00 s3/ 10 s0 [05:25]
KRIZEK Simon	CZE	5	KRIZEK S. (CZE)
LEKISHVILI Heorhii	UKR	6	LEKISHVILI H. (UKR) 35
LEKISHVILI H. (UKR)			10 s0/ 00 s0 [01:06]
LEMPICKI Kacper	POL	7	MURAWSKI M. (GER)
MURAWSKI Maximilian	GER	7	00 s0/ 10 s0 [00:43]
JEAN Peter	FRA	8	JEAN P. (FRA) 36
JEAN P. (FRA)			01 s2/ 00 s0 [04:00]

POOL B

HUSEYNOV Gadir	AZE	9	HUSEYNOV G. (AZE)
MAMINSKI Konrad	POL	10	MAMINSKI K. (POL) 37
MAMINSKI K. (POL)			02 s0/ 00 s0 [01:12]
GOKER Yücel	TUR	11	GOKER Y. (TUR)
MATTSSON Ville	SWE	11	10 s0/ 00 s0 [00:58]
MALONKIN Bohdan	UKR	12	MALONKIN B. (UKR) 38
MALONKIN B. (UKR)			00 s2/ 01 s2 [04:00]
RODMAN Billy	GBR	13	RODMAN B. (GBR)
WANDTKE Viktor Marko	GER	14	WANDTKE V. (GER) 39
WANDTKE V. (GER)			00 s1/ 01 s1 [04:00]
KUCZYNSKI Jakub	POL	15	KUCZYNSKI J. (POL)
RANKINEN Jere	FIN	15	10 s0/ 00 s3 [03:42]
BEYER Thibaut	FRA	16	BEYER T. (FRA) 40
BEYER T. (FRA)			01 s0/ 00 s2 [05:25]

POOL C

KULIESHOV Nazar	UKR	17	KULIESHOV N. (UKR)
CHRYSCINA Adam	POL	18	CHRYSCINA A. (POL) 41
CHRYSCINA A. (POL)			02 s0/ 00 s0 [01:32]
ADIYAMAN Hidayet	TUR	19	DABAYA J. (FRA)
DABAYA Junior	FRA	19	00 s2/ 10 s1 [04:17]
MAGNANO Alberto	ITA	20	MAGNANO A. (ITA) 42
MAGNANO A. (ITA)			02 s0/ 00 s0 [02:47]
BEBEY Lionel	FRA	21	BEBEY L. (FRA)
HABZO Ariel	ISR	22	KAZIMIERCZAK A. (POL) 43
KAZIMIERCZAK Adam	POL	22	00 s1/ 02 s1 [03:40]
ALIYEV Suleyman	AZE	23	ALIYEV S. (AZE)
REDDIG Finn Luka	GER	24	REDDIG F. (GER) 44
REDDIG F. (GER)			02 s1/ 00 s1 [03:28]

POOL D

ESPOSITO Fabrizio	ITA	25	ESPOSITO F. (ITA)
SWIDWA Marcin	POL	26	SWIDWA M. (POL) 45
SWIDWA M. (POL)			10 s0/ 00 s0 [00:30]
VAN DER VEEN Quinten	NED	26	GAZALOEV M. (BEL)
LUTSYK Maksym	UKR	27	00 s1/ 10 s0 [00:40]
GAZALOEV Mouhammad	BEL	27	GAZALOEV M. (BEL) 46
DJEZAR Chakir	FRA	28	DJEZAR C. (FRA) 46
DJEZAR C. (FRA)			01 s1/ 00 s1 [04:00]
POTAPOVS Emils	LAT	29	POTAPOVS E. (LAT)
JAGIELSKI Aleksander	POL	30	JAGIELSKI A. (POL) 47
JAGIELSKI A. (POL)			11 s0/ 00 s0 [02:10]
AKISHEV Nazar	UKR	31	AKISHEV N. (UKR)
LEPIANKA Bartosz	POL	31	10 s0/ 00 s0 [02:18]
TURGUTLU Abdullah	TUR	32	TURGUTLU A. (TUR) 48
TURGUTLU A. (TUR)			10 s0/ 00 s0 [01:10]

REPECHAGE

LEMPICKI K. (POL)			JEAN P. (FRA)
JEAN P. (FRA)	61		00 s3/ 11 s0 [02:19]
			KRIZEK S. (CZE)
		65	11 s1/ 00 s1 [03:53]
			PELLIGRA V. (ITA)
		69	00 s3/ 10 s0 [03:07]
MAMINSKI K. (POL)	62		MAMINSKI K. (POL)
MALONKIN B. (UKR)	62		10 s0/ 00 s0 [00:34]
		70	WANDTKE V. (GER)
			00 s2/ 10 s1 [06:45]
REDDIG F. (GER)	63		REDDIG F. (GER)
		67	BEBEY L. (FRA)
			00 s0/ 02 s0 [01:45]
		71	KULIESHOV N. (UKR)
			00 s0/ 11 s1 [03:02]
SWIDWA M. (POL)	64		SWIDWA M. (POL)
		68	GAZALOEV M. (BEL)
			00 s0/ 10 s0 [00:23]
		72	GAZALOEV M. (BEL)
			10 s0/ 00 s0 [00:16]

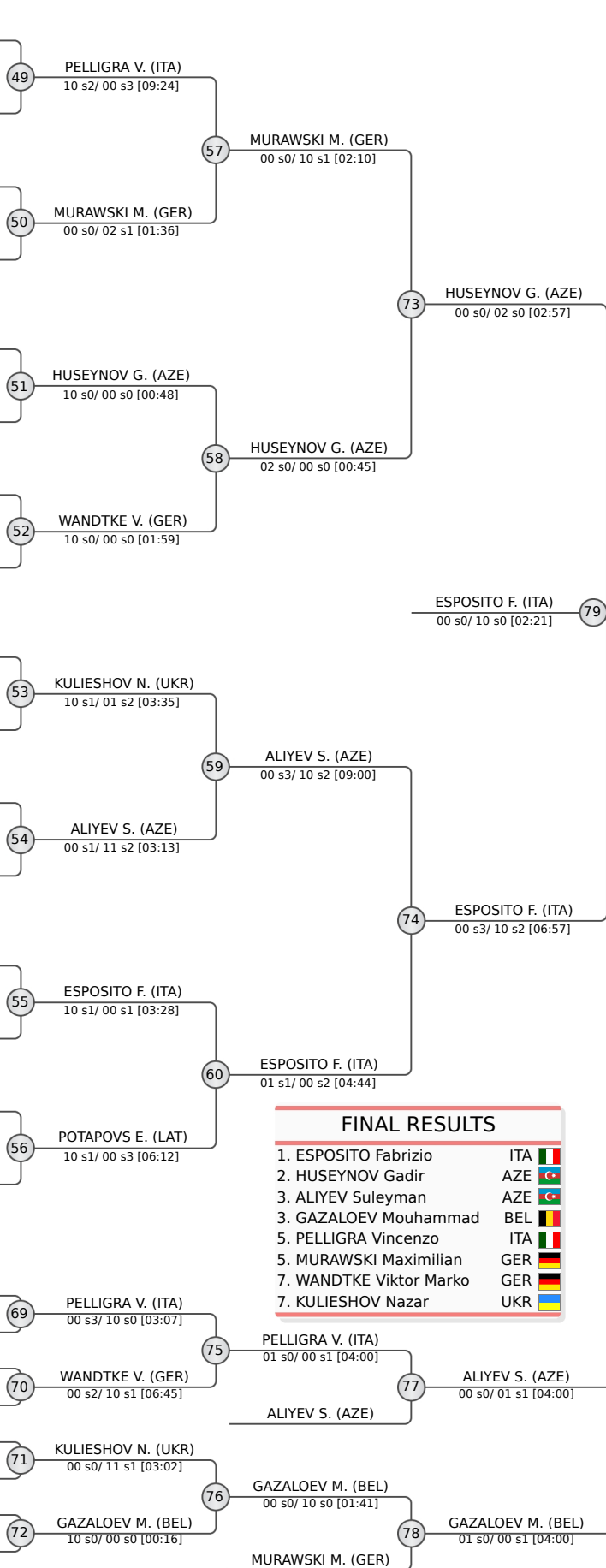



Poznan Junior European Cup 2023

Poland, Poznan, 15-16 Apr 2023

-81 kg

Juniors (44)

POOL A

1	MADDALONI NOSA Bright (ITA)	33	MADDALONI NOSA B. (ITA)
2	OKOYE Jason (FRA)	34	BOUATIA K. (POL)
3	MIHALOVS Ivans (LAT)	35	DAVID H. (FRA)
4	BOUATIA Kamil (POL)	36	GOLLAND C. (GER)
5	ZULYS Algirdas (LTU)		
6	SAHIN Ibrahim Melih (TUR)		
7	MATTSSON Pelle (SWE)		
8	WATKOWSKI Kacper (POL)		
	DAVID Hugo (FRA)		
	GOLLAND Caspar (GER)		
	TOKHTAMYSH Oleksandr (UKR)		

POOL B

9	TSURKAN Igor (UKR)	37	TSURKAN I. (UKR)
10	FOUQUET-PERTUSA Lucas (FRA)	38	DECORTE R. (BEL)
11	KOMPE Mertcan (TUR)	39	RAJABLI O. (AZE)
12	DECORTE Remi (BEL)	40	DE LANGE J. (NED)
13	TAMA Alexandre (FRA)		
14	RAJABLI Omar (AZE)		
15	BEREZHNYI Rostyslav (UKR)		
16	ROGALSKI Oskar (POL)		
	DE LANGE Joshua (NED)		
	MLADY Petr (CZE)		
	TOUTOU Tarik Ziad (FRA)		

POOL C

17	BELLINI Alessandro (ITA)	41	BELLINI A. (ITA)
18	PUCHLY Thomas (FRA)	42	YLIRUUSI T. (FIN)
19	KAZIMIROV Ivan (UKR)	43	ONANA A. (FRA)
20	YLIRUUSI Teo (FIN)	44	TARKOWSKI F. (POL)
21	VAN SINDEREN Mika (NED)		
22	SZADEJKO Bartlomiej (POL)		
23	SALVETTI Elia (ITA)		
24	ONANA Aristide (FRA)		
	HAKANSON Rasmus (SWE)		
	TARKOWSKI Fabrycjusz (POL)		
	PLOSTNIEKS Ronalds (LAT)		

POOL D

25	KHAITAEV Rassoul (FRA)	45	KLYMENKO I. (UKR)
26	NARKUS Tadas (LTU)	46	HAJIZADA A. (AZE)
27	KLYMENKO Illia (UKR)	47	CHRISTIAENS N. (BEL)
28	DEMAREZ Nolann (FRA)	48	GUSZCZIN M. (POL)
29	HAJIZADA Ali (AZE)		
30	PONS Bastien (FRA)		
31	JANKOVIC Juraj (SVK)		
32	CHRISTIAENS Noah (BEL)		
	GUSZCZIN Marcin (POL)		
	YATSOLA Ivan (UKR)		
	ELBAS Selahattin (TUR)		

REPECHAGE

61	MIHALOVS I. (LAT)	65	BOUATIA K. (POL)
62	FOUQUET-PERTUSA L. (FRA)	66	DECORTE R. (BEL)
63	KAZIMIROV I. (UKR)	67	YLIRUUSI T. (FIN)
64	JANKOVIC J. (SVK)	68	GUSZCZIN M. (POL)
	PONS B. (FRA)		

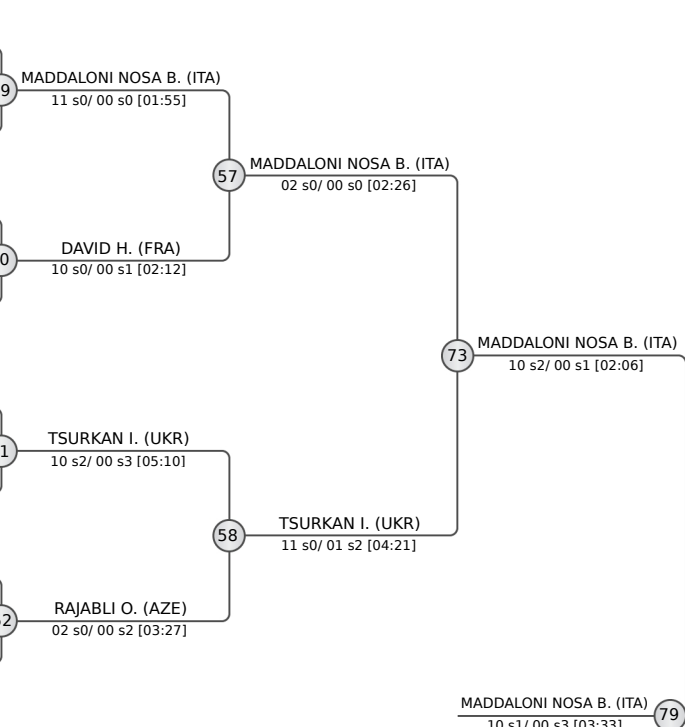

FINAL RESULTS		
1.	MADDALONI NOSA Bright	ITA
2.	BELLINI Alessandro	ITA
3.	CHRISTIAENS Noah	BEL
3.	TSURKAN Igor	UKR
5.	RAJABLI Omar	AZE
5.	SALVETTI Elia	ITA
7.	DAVID Hugo	FRA
7.	KLYMENKO Illia	UKR





Poznan Junior European Cup 2023

Poland, Poznan, 15-16 Apr 2023

-90 kg

Juniors (46)

POOL A

1	DUINOVŠ Maksims LAT	DUINOVŠ M. (LAT)	33	CUREAU B. (FRA)	01 s3/ 10 s0 [02:32]	
2	CUREAU Baptiste FRA	CUREAU B. (FRA)	02 s0/ 00 s1 [01:53]	49	CUREAU B. (FRA)	02 s0/ 00 s1 [02:40]
3	CALIK Yalcin TUR	MARCIN W. (POL)	34	MARCIN W. (POL)	10 s0/ 00 s0 [03:00]	
4	MARCIN Walenciak POL	VOLKOV K. (LTU)	35	MARUSKA A. (SVK)	10 s0/ 00 s0 [00:42]	
5	VOLKOV Kiril LTU	MARUSKA A. (SVK)	36	YURCHAK N. (UKR)	00 s2/ 02 s2 [03:48]	
6	MARUSKA Alex SVK	DENYS W. (BEL)	37	YURCHAK N. (UKR)	10 s0/ 00 s0 [02:50]	
7	KUESTER Ilias GER	DENYS W. (BEL)	38	ZAWISTOWSKI F. (POL)		
8	DENYS Warre BEL	YURCHAK N. (UKR)				
	DOL Giel NED	YURCHAK N. (UKR)				
	YURCHAK Nazarii UKR					
	ZAWISTOWSKI Franciszek POL					

POOL B

9	FAVA Tommaso ITA	FAVA T. (ITA)	37	KIELESINSKI J. (POL)	00 s0/ 10 s1 [01:16]
10	OZTAS Mevlut TUR	KIELESINSKI J. (POL)	38	DEN HARTOG F. (NED)	00 s2/ 01 s1 [04:00]
11	KIELESINSKI Jakub POL	DEN HARTOG F. (NED)	39	DEN HARTOG F. (NED)	10 s1/ 02 s2 [05:22]
12	VIRGINA Kevin FRA	MAIBORODA I. (UKR)	40	KLYMOV V. (UKR)	00 s0/ 10 s0 [00:13]
13	DEN HARTOG Floris NED	ZAMANOV I. (AZE)	39	ZAMANOV I. (AZE)	11 s1/ 00 s0 [00:52]
14	MAIBORODA Ivan UKR	LHOTZKY F. (CZE)	40	KLYMOV V. (UKR)	00 s0/ 10 s0 [00:13]
15	ZAMANOV Ismayil AZE	BERTHELEMY M. (FRA)	41	BOLDYRIEV O. (UKR)	10 s2/ 00 s3 [04:37]
16	LHOTZKY Frantisek CZE	BERTHELEMY M. (FRA)	42	VRIELING W. (NED)	00 s0/ 11 s0 [01:18]
17	WAWRZONEK Jakub POL	BERTHELEMY M. (FRA)	43	WASIKOWSKI M. (POL)	00 s1/ 10 s1 [04:26]
18	WESTERMARCK Pyry FIN	BERTHELEMY M. (FRA)	44	CHERNYSHENKO I. (FRA)	00 s0/ 11 s0 [01:13]
19	BERTHELEMY Maxence FRA	BERTHELEMY M. (FRA)	45	CHERNYSHENKO I. (FRA)	10 s0/ 00 s0 [00:51]
20	KLYMOV Vsevolod UKR	KLYMOV V. (UKR)	46	LAUFMANIS E. (LAT)	10 s2/ 00 s3 [05:28]

POOL C

17	BOLDYRIEV Oleksii UKR	BOLDYRIEV O. (UKR)	41	BOLDYRIEV O. (UKR)	10 s2/ 00 s3 [04:37]
18	LENCEŠ Adam SVK	BIZANS M. (LAT)	42	VRIELING W. (NED)	00 s0/ 11 s0 [01:18]
19	BIZANS Maksims LAT	DRAG S. (POL)	43	WASIKOWSKI M. (POL)	00 s1/ 10 s1 [04:26]
20	BASCHIN Jannis GER	DRAG S. (POL)	44	CHERNYSHENKO I. (FRA)	00 s0/ 11 s0 [01:13]
21	DRAG Stanislaw POL	VRIELING W. (NED)	45	CHERNYSHENKO I. (FRA)	10 s0/ 00 s0 [00:51]
22	VRIELING Willem NED	SLYTERIS A. (LTU)	46	LAUFMANIS E. (LAT)	10 s2/ 00 s3 [05:28]
23	SLYTERIS Augustas LTU	WASIKOWSKI M. (POL)	47	VAN OOSTRUM L. (NED)	01 s1/ 02 s1 [02:46]
24	KARACAN Firat TUR	WASIKOWSKI M. (POL)	48	PAGSTEDT A. (SWE)	
25	WASIKOWSKI Michal POL	WASIKOWSKI M. (POL)	49	IMENEZ T. (FRA)	00 s0/ 10 s0 [00:26]
26	OMELCHENKO Bohdan UKR	CHERNYSHENKO I. (FRA)	50	IMENEZ T. (FRA)	10 s0/ 00 s0 [00:56]
27	CHERNYSHENKO Ivan FRA	CHERNYSHENKO I. (FRA)	51	BAGHIROV A. (AZE)	00 s0/ 10 s0 [00:12]
28	KARATSAOUSIDIS Theocharis CYP	KARATSAOUSIDIS T. (CYP)	52	BAGHIROV A. (AZE)	01 s0/ 00 s1 [04:53]

POOL D

25	KUTENKOV Ivan UKR	KUTENKOV I. (UKR)	45	BAGHIROV A. (AZE)	00 s0/ 10 s1 [02:54]
26	YAPICI Suat Can TUR	BAGHIROV A. (AZE)	46	SOUSSI I. (FRA)	10 s2/ 00 s3 [05:28]
27	BAGHIROV Azhdar AZE	SOUSSI I. (FRA)	47	VAN OOSTRUM L. (NED)	01 s1/ 02 s1 [02:46]
28	SOUSSI Ilias FRA	BOGDANIUK Jakub POL	48	IMENEZ T. (FRA)	10 s0/ 00 s0 [00:56]
29	BOGDANIUK Jakub POL	LAUFMANIS E. (LAT)	49	IMENEZ T. (FRA)	10 s0/ 00 s0 [00:56]
30	LAUFMANIS Ernests LAT	RAFFAELI A. (ITA)	50	IMENEZ T. (FRA)	10 s0/ 00 s0 [00:56]
31	RAFFAELI Andrea ITA	VAN OOSTRUM L. (NED)	51	BAGHIROV A. (AZE)	01 s1/ 00 s0 [04:24]
32	ZAWIDZKI Jan POL	VAN OOSTRUM L. (NED)	52	IMENEZ T. (FRA)	00 s0/ 10 s0 [00:26]
33	VAN OOSTRUM Lars NED	IMENEZ T. (FRA)	53	IMENEZ T. (FRA)	10 s0/ 00 s0 [00:56]
34	IMENEZ Thomas FRA	PAGSTEDT A. (SWE)	54	IMENEZ T. (FRA)	10 s0/ 00 s0 [00:56]
35	PAGSTEDT Arvid SWE		55	IMENEZ T. (FRA)	10 s0/ 00 s0 [00:56]

REPECHAGE

61	DOL G. (NED)	DOL G. (NED)	65	MARUSKA A. (SVK)	00 s2/ 01 s2 [04:00]
62	ZAWISTOWSKI F. (POL)	MARUSKA A. (SVK)	66	KIELESINSKI J. (POL)	01 s0/ 02 s1 [04:29]
63	VIRGINA K. (FRA)	VIRGINA K. (FRA)	67	VRIELING W. (NED)	00 s2/ 10 s1 [02:27]
64	MAIBORODA I. (UKR)	KIELESINSKI J. (POL)	68	KUTENKOV I. (UKR)	11 s0/ 01 s0 [05:14]
65	BIZANS M. (LAT)	BIZANS M. (LAT)	69	IMENEZ T. (FRA)	02 s0/ 00 s0 [01:44]
66	YAPICI S. (TUR)	VRIELING W. (NED)	70	ZAMANOV I. (AZE)	00 s2/ 11 s1 [03:28]
67	KUTENKOV I. (UKR)	CHERNYSHENKO I. (FRA)	71	CHERNYSHENKO I. (FRA)	00 s0/ 10 s0 [00:58]
68		CHERNYSHENKO I. (FRA)	72	KUTENKOV I. (UKR)	01 s1/ 02 s0 [03:02]
69		KUTENKOV I. (UKR)	73	YURCHAK N. (UKR)	00 s0/ 02 s0 [01:39]
70		IMENEZ T. (FRA)	74	DEN HARTOG F. (NED)	00 s2/ 01 s0 [05:16]
71		IMENEZ T. (FRA)	75	DEN HARTOG F. (NED)	10 s1/ 00 s2 [03:31]
72		IMENEZ T. (FRA)	76	DEN HARTOG F. (NED)	10 s2/ 00 s0 [02:23]
73		IMENEZ T. (FRA)	77	DEN HARTOG F. (NED)	10 s2/ 00 s0 [02:23]
74		IMENEZ T. (FRA)	78	DEN HARTOG F. (NED)	10 s2/ 00 s0 [02:23]
75		IMENEZ T. (FRA)	79	DEN HARTOG F. (NED)	10 s2/ 00 s0 [02:23]

FINAL RESULTS

1.	DEN HARTOG Floris	NED
2.	BOLDYRIEV Oleksii	UKR
3.	ZAMANOV Ismayil	AZE
3.	KUTENKOV Ivan	UKR
5.	BAGHIROV Azhdar	AZE
5.	YURCHAK Nazarii	UKR
7.	CUREAU Baptiste	FRA
7.	CHERNYSHENKO Ivan	FRA





Poznan Junior European Cup 2023

Poland, Poznan, 15-16 Apr 2023

-100 kg

Juniors (18)

POOL A

	DUDY David	CZE	1	DUDY D. (CZE)
	OLEKSY Mateusz	POL	2	OLEKSY M. (POL)
	KARA Yakup	TUR	3	KARA Y. (TUR)
	MAKSIMOV Denis	LTU	4	MAKSIMOV D. (LTU)

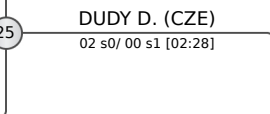
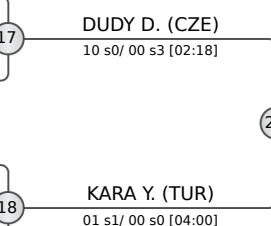

POOL B

	BORDIN Maxence	FRA	5	BORDIN M. (FRA)
	KUBIAK Damian	POL	6	KUBIAK D. (POL)
	DZABAROV S Tamerlans	AZE	7	02 s1/ 01 s1 [02:56]
	AKKUS Sidar	TUR	7	AKKUS S. (TUR)
	RIEMENS Timon	NED	8	RIEMENS T. (NED)

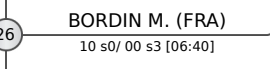
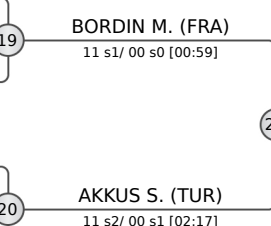

POOL C

	BULTHUIS Silvan	NED	9	BULTHUIS S. (NED)
	BURAN Halil	TUR	10	BURAN H. (TUR)
	BEREHULSKYY Nikita	UKR	11	BEREHULSKYY N. (UKR)
	MROZEK Jakub	POL	12	MROZEK J. (POL)

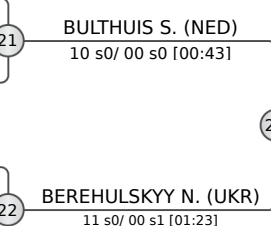

POOL D

	CARLETTI Jean	ITA	13	CARLETTI J. (ITA)
	LUTZ Hugo	FRA	14	TIYEK C. (TUR)
	TIYEK Cihan Ayberk	TUR	14	00 s0/ 02 s0 [01:33]
	WALENCIAK Michal	POL	15	WALENCIAK M. (POL)
	SUHA Mortaza	GER	16	SUHA M. (GER)

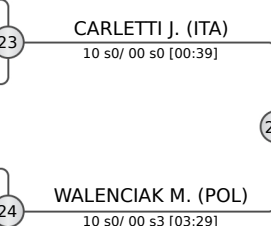

FINAL RESULTS	
1.	BULTHUIS Silvan NED
2.	BORDIN Maxence FRA
3.	CARLETTI Jean ITA
3.	DUDY David CZE
5.	KUBIAK Damian POL
5.	WALENCIAK Michal POL
7.	OLEKSY Mateusz POL
7.	BURAN Halil TUR

REPECHAGE

29	OLEKSY M. (POL)	33	OLEKSY M. (POL)
30	KUBIAK D. (POL)	34	KUBIAK D. (POL)
31	BURAN H. (TUR)	35	BURAN H. (TUR)
32	TIYEK C. (TUR)	36	WALENCIAK M. (POL)

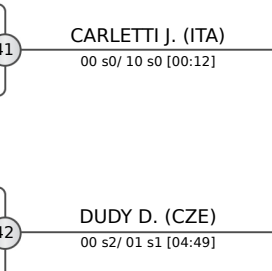
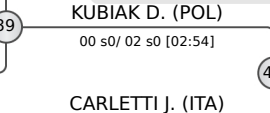
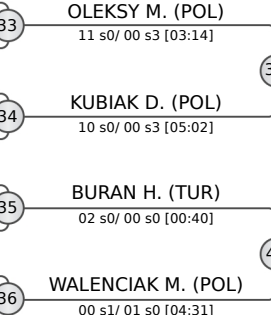



Poznan Junior European Cup 2023

Poland, Poznan, 15-16 Apr 2023

+ 100 kg

Juniors (10)

POOL A

	TERESINSKI Grzegorz	POL
	KLOS Milosz	POL
	DADIANI Georgi	FRA

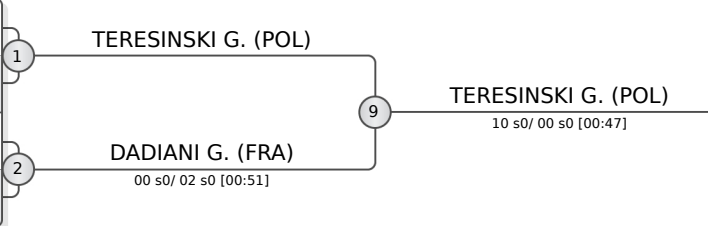

POOL B

	STRAZDINS Janis	LAT
	TUTAR Tunahan	TUR

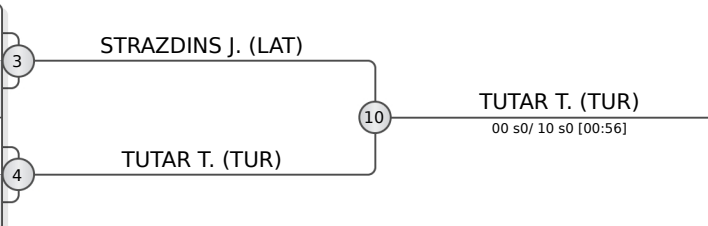

POOL C

	SORDYL Jakub	POL
	ERGIN Recep	TUR

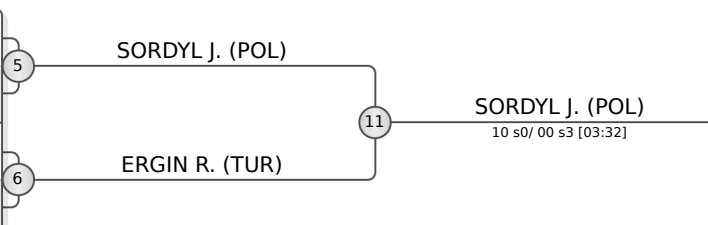

POOL D

	NASIBOV Kanan	AZE
	JANKOWSKI Wiktor	POL
	COLAKCIVI Mehmet Emin	TUR

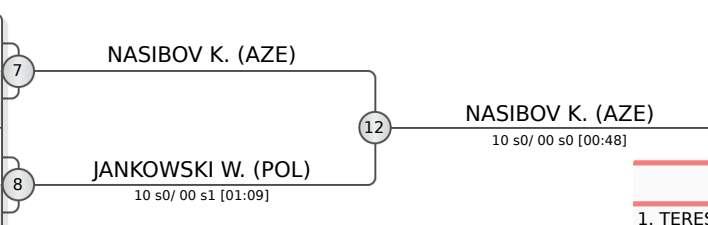

FINAL RESULTS		
1.	TERESINSKI Grzegorz	POL
2.	SORDYL Jakub	POL
3.	NASIBOV Kanan	AZE
3.	ERGIN Recep	TUR
5.	STRAZDINS Janis	LAT
5.	TUTAR Tunahan	TUR
7.	DADIANI Georgi	FRA
7.	JANKOWSKI Wiktor	POL

REPECHAGE

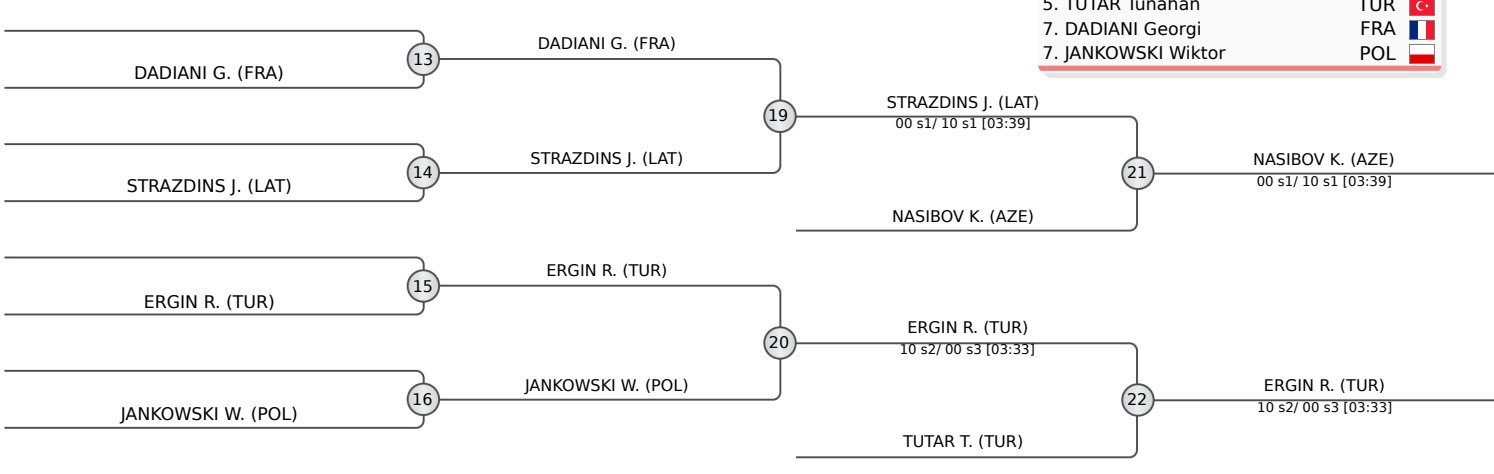



Poznan Junior European Cup 2023

Poland, Poznan, 15-16 Apr 2023

-48 kg
Juniors (25)

POOL A

	BABULFATH Tara	SWE
	VALERIANI Rebecca	ITA
	ERTEM Zilan	TUR
	GUARDUCCI Elena	ITA
	KOZUCH Oliwia	POL
	PECQUEUX Maia	FRA
	DAMIROVA Leyla	AZE

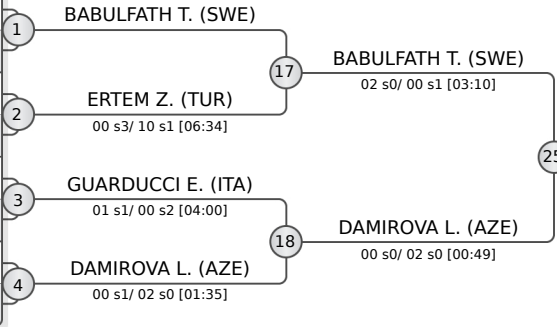

POOL B

	MAZZOLA Sofia	ITA
	KIRT Elif	TUR
	MERMET Clara	FRA
	ONYSK Oliwia	POL
	MEDEMA Maira	NED
	VANDEVOORT Lotte	BEL

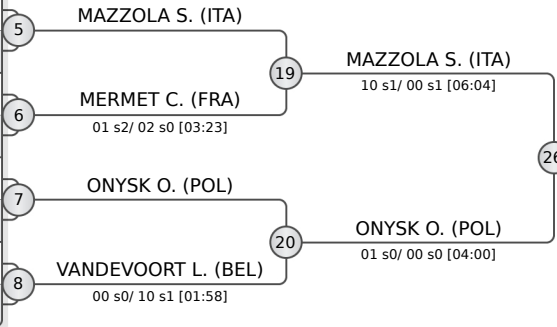

POOL C

	GHIGLIONE Giulia	ITA
	SUPERSON Anastasiia	UKR
	BELLANCE Loryn	FRA
	HENDRIKS Milou	NED
	ALKIS Merve Nur	TUR
	PLATANIA Aurora	ITA

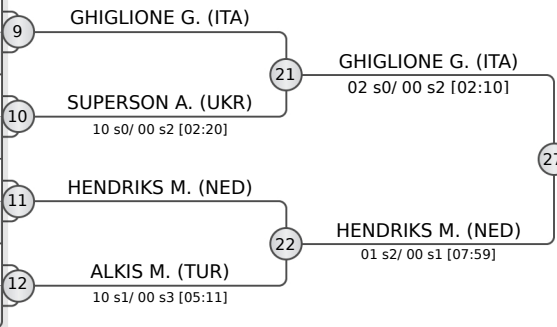

POOL D

	GIORGI Giulia	ITA
	RICHARD Clementine	FRA
	OZ Ayse	TUR
	WOZNIAK Zuzanna	POL
	WANDEL Vera	NED
	SIBILLE Victoria	BEL

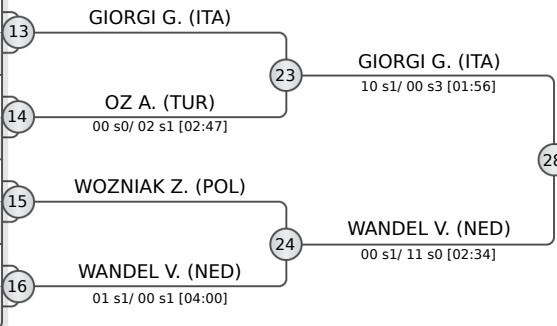

REPECHAGE

	ERTEM Z. (TUR)	29
	MERMET C. (FRA)	30
	SUPERSON A. (UKR)	31
	OZ A. (TUR)	32

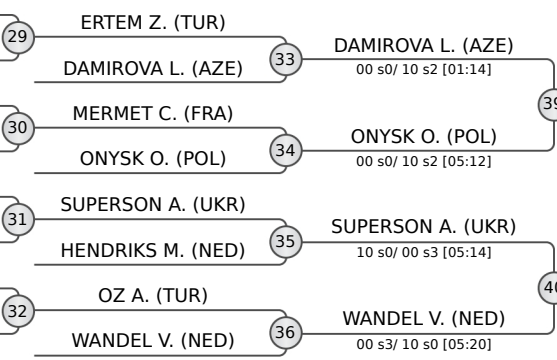

BABULFATH T. (SWE) [04:36] → 43

FINAL RESULTS	
1.	BABULFATH Tara (SWE)
2.	GIORGI Giulia (ITA)
3.	GHIGLIONE Giulia (ITA)
3.	SUPERSON Anastasiia (UKR)
5.	DAMIROVA Leyla (AZE)
7.	ONYSK Oliwia (POL)
7.	WANDEL Vera (NED)





Poznan Junior European Cup 2023

Poland, Poznan, 15-16 Apr 2023

-52 kg

Juniors (34)

POOL A

1	TORTORICI Alessia (ITA)	33	TORTORICI A. (ITA)	10 s0/ 00 s0 [00:57]
2	SLOBODENIUK Alina (UKR)	34	ZAKRZEWSKA A. (POL)	00 s3/ 10 s2 [04:18]
3	GAVALA Evangelia (GRE)	35	BOGA P. (TUR)	01 s2/ 02 s1 [04:55]
4	ZAKRZEWSKA Anna (POL)	36	SCIACOVELLI M. (ITA)	00 s1/ 10 s2 [03:02]
5	SYDYKOVA Karina (KGZ)	37	HORAKOVA V. (CZE)	10 s0/ 01 s3 [03:00]
6	BOGA Pinar (TUR)	38	VAN LEEUWEN E. (NED)	01 s1/ 00 s1 [04:00]
7	KUTYLA Oliwia (POL)	39	SIENNICKA K. (POL)	10 s0/ 00 s3 [02:46]
8	ARSHAKYAN Vilena (EST)	40	KRAUSE K. (GER)	00 s0/ 02 s0 [00:53]
	SCIACOVELLI Micaela (ITA)			

POOL B

9	HORAKOVA Veronika (CZE)	41	KLIMCZAK K. (POL)	11 s0/ 00 s1 [01:19]
10	WENZEL Aleksandra (POL)	42	ROCCO A. (ITA)	00 s1/ 02 s0 [02:55]
11	VAN LEEUWEN Emma (NED)	43	SASSI A. (ITA)	10 s0/ 00 s3 [02:15]
12	MELLOUANI Meriem (FRA)	44	JENMAN C. (GBR)	00 s1/ 01 s1 [04:00]
13	SIENNICKA Karolina (POL)	45	BOTHY S. (FRA)	00 s2/ 01 s1 [06:23]
14	DISPENZA Chiara Antonina (ITA)	46	YILDIRIM S. (TUR)	02 s0/ 00 s0 [01:12]
15	NERI Jana (BEL)	47	MAMMADOVA Z. (AZE)	00 s3/ 10 s0 [02:46]
16	KRAUSE Kathrin (GER)	48	WARNERS G. (NED)	01 s0/ 10 s1 [02:30]

POOL C

17	KLIMCZAK Kinga (POL)	49	TORTORICI A. (ITA)	10 s0/ 00 s1 [01:29]
18	LIMZAIIEVA Tetiana (UKR)	50	SCIACOVELLI M. (ITA)	00 s3/ 10 s1 [03:43]
19	OLEMANS Fieke (BEL)	51	HORAKOVA V. (CZE)	02 s2/ 00 s2 [04:00]
20	ROCCO Alessandra (ITA)	52	SIENNICKA K. (POL)	02 s0/ 00 s0 [00:35]
21	SASSI Asia (ITA)	53	KLIMCZAK K. (POL)	11 s0/ 00 s1 [02:40]
22	ARSLAN Meryem Iclal (TUR)	54	SASSI A. (ITA)	10 s2/ 00 s3 [03:35]
23	ROZENBAUM Magdalena (POL)	55	BOTHY S. (FRA)	10 s0/ 01 s0 [02:37]
24	WEKKING Renske (NED)	56	MAMMADOVA Z. (AZE)	10 s1/ 00 s0 [01:54]
	JENMAN Charlotte (GBR)			

POOL D

25	STELLA Gaia (ITA)	57	SCIACOVELLI M. (ITA)	00 s3/ 10 s0 [07:57]
26	BOTHY Sarah (FRA)	58	SIENNICKA K. (POL)	00 s0/ 10 s0 [02:58]
27	YILDIRIM Seyma (TUR)	59	KLIMCZAK K. (POL)	01 s0/ 00 s2 [04:11]
28	ERIKSSON GHAZINOUR Isabella (SWE)	60	BOTHY S. (FRA)	10 s0/ 00 s1 [03:02]
29	FINESTRONE Ilaria (ITA)	61	KUTYLA O. (POL)	
30	MAMMADOVA Zeynab (AZE)	62	DISPENZA C. (ITA)	
31	SZULC Aleksandra (POL)	63	LIMZAIIEVA T. (UKR)	
32	WARNERS Glen (NED)	64	STELLA G. (ITA)	

REPECHAGE

61	KUTYLA O. (POL)	65	BOGA P. (TUR)	00 s0/ 11 s0 [01:42]
62	DISPENZA C. (ITA)	66	KRAUSE K. (GER)	00 s0/ 10 s0 [00:49]
63	LIMZAIIEVA T. (UKR)	67	LIMZAIIEVA T. (UKR)	10 s2/ 00 s1 [05:34]
64	STELLA G. (ITA)	68	YILDIRIM S. (TUR)	00 s0/ 01 s0 [04:00]

FINAL RESULTS

- KLIMCZAK Kinga (POL)
- SCIACOVELLI Micaela (ITA)
- TORTORICI Alessia (ITA)
- SIENNICKA Karolina (POL)
- BOTHY Sarah (FRA)
- YILDIRIM Seyma (TUR)
- HORAKOVA Veronika (CZE)
- SASSI Asia (ITA)





Poznan Junior European Cup 2023

Poland, Poznan, 15-16 Apr 2023

-57 kg
Juniors (23)

POOL A

	CARNA Giulia	ITA
	KAYDU Helin	TUR
	MELIS Emma	FRA
	WATSON Nora	BEL
	TIELIEGINA Anna	UKR
	WAKUP Nehle	GER

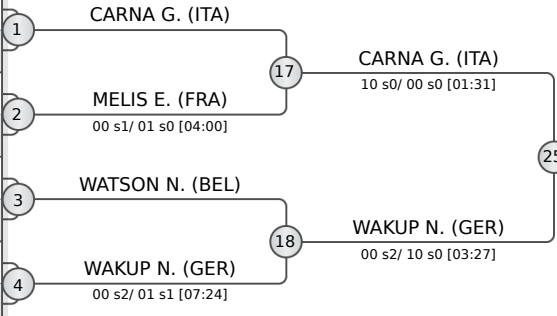

POOL B

	KARADAG Aysenur	TUR
	FACHE Lola	BEL
	DZIOB Wiktoria	POL
	POLNICKA Marie	CZE
	PECQUEUX Manon	FRA
	KORKMAZ Gulzade	TUR

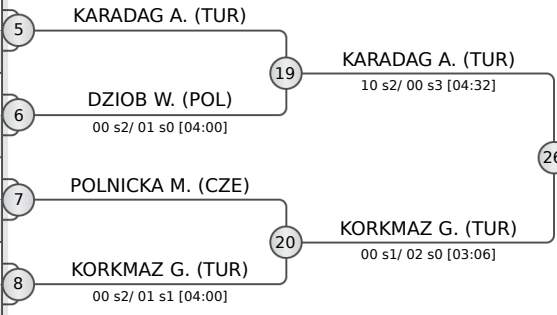

POOL C

	CAPANNI DIAS Thauany David	ITA
	OGUZ Reyhan	TUR
	ABBASOVA Latifa	AZE
	GRANATA Lucinda	FRA
	KUZMENKO Yuliia	UKR

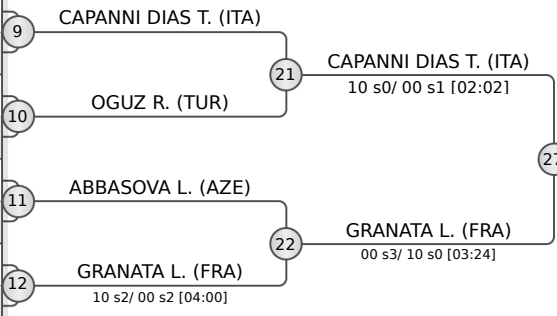

POOL D

	CHMIELEWSKA Kinga	POL
	VAN KERKHOFF Mirthe	NED
	VERFAILLIE Luna	BEL
	BULANDA Julia	POL
	VACLAVKOVA Tereza	CZE
	BUDAK Aysenur	TUR

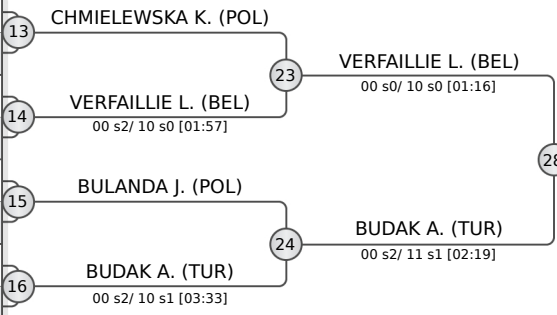

REPECHAGE

MELIS E. (FRA) 29	MELIS E. (FRA)	33
DZIOB W. (POL) 30	DZIOB W. (POL)	34
OGUZ R. (TUR) 31	OGUZ R. (TUR)	35
VACLAVKOVA T. (CZE) 32	BULANDA J. (POL) 00 s1/ 10 s1 [03:26]	36
	VERFAILLIE L. (BEL)	

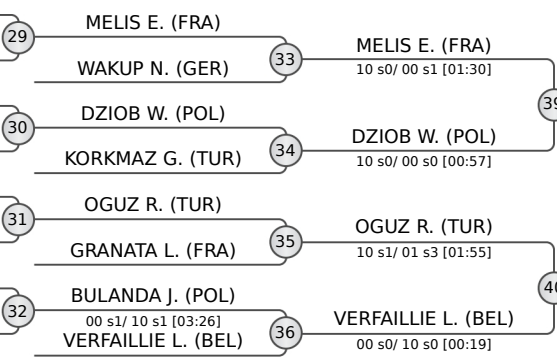

FINAL RESULTS	
1.	CAPANNI DIAS Thauany David ITA
2.	CARNA Giulia ITA
3.	MELIS Emma FRA
3.	VERFAILLIE Luna BEL
5.	BUDAK Aysenur TUR
5.	KARADAG Aysenur TUR
7.	DZIOB Wiktoria POL
7.	OGUZ Reyhan TUR





Poznan Junior European Cup 2023

Poland, Poznan, 15-16 Apr 2023

-63 kg

Juniors (28)

POOL A

	PALUMBO Antonietta	ITA
	BACKLUND Vilda	SWE
	GRAENITZ Emily	GER
	BADURA Daniela	POL
	COMART Betul	TUR
	BRUHL Loriane	FRA
	MAKINEN Ida	FIN

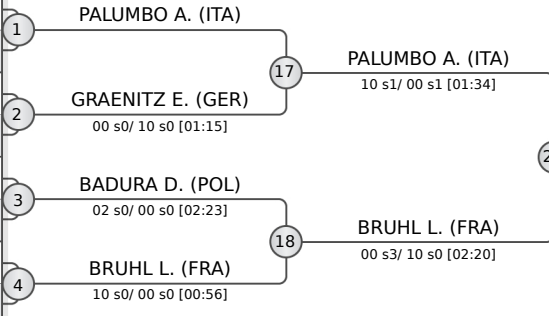

POOL B

	KROON Esmee	NED
	KONFISZ Amelia	POL
	KOVAC Tina	SLO
	RENES Elena	NED
	RIDDERSKAMP Halwiga	GER
	YILDIZTEKIN Beyzanur	TUR
	CASTIELLO Chiara	ITA

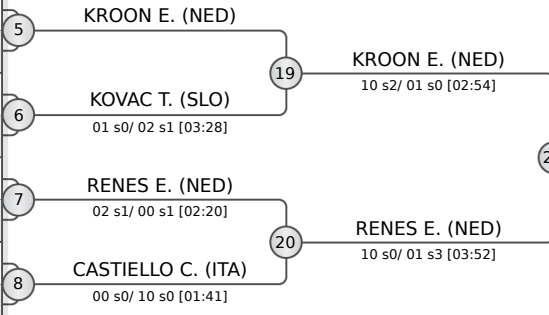

POOL C

	CORBO Sara	ITA
	NOACK Nele	GER
	AYAN Sila	TUR
	FROSONI Giulia	ITA
	WOLKOWICZ Emilia	POL
	GRASSIN Eva	FRA
	UIJTENDAAL Blanca	NED

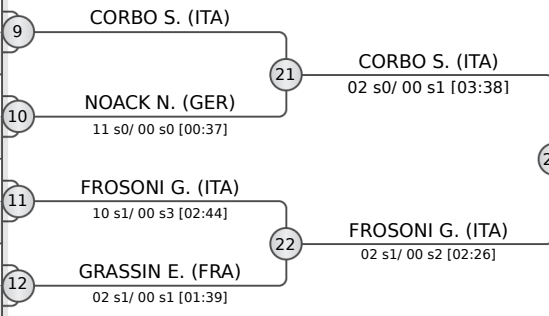

POOL D

	GLUBIAK Martyna	POL
	STEFFERS Bo	NED
	AGDEVE Aysun	TUR
	DIGWEED Phoebe	GBR
	ÖSTLIND Gretha	SWE
	RUSSO Savita	ITA
	SEIKKULA Louna-Lumia	FIN

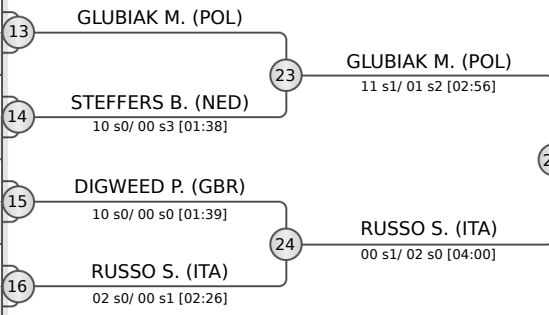

REPECHAGE

	GRAENITZ E. (GER)	29
	KOVAC T. (SLO)	30
	NOACK N. (GER)	31
	SEIKKULA L. (FIN)	32
	DIGWEED P. (GBR)	32
	GRAENITZ E. (GER)	33
	KOVAC T. (SLO)	34
	NOACK N. (GER)	35
	SEIKKULA L. (FIN)	36
	GLUBIAK M. (POL)	36

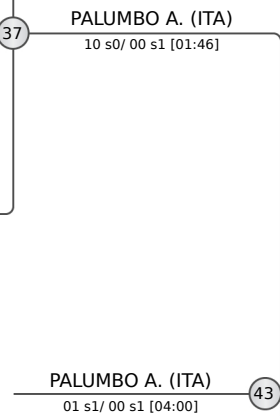
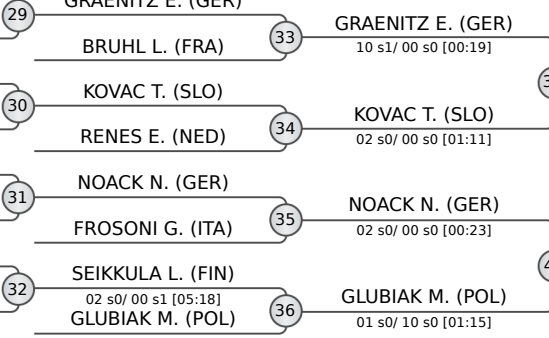

FINAL RESULTS		
1.	PALUMBO Antonietta	ITA
2.	RUSSO Savita	ITA
3.	CORBO Sara	ITA
5.	GRAENITZ Emily	GER
5.	GLUBIAK Martyna	POL
7.	KOVAC Tina	SLO
7.	NOACK Nele	GER





Poznan Junior European Cup 2023

Poland, Poznan, 15-16 Apr 2023

-70 kg

Juniors (27)

POOL A

ZARYBNICKA Julie	CZE
KUSKU Elif	TUR
PAPP Maria	EST
THIELE Jenna	GER
ROMANIUK Marcelina	POL
MADDALONI Serena	ITA
TSIMKO Olga	UKR

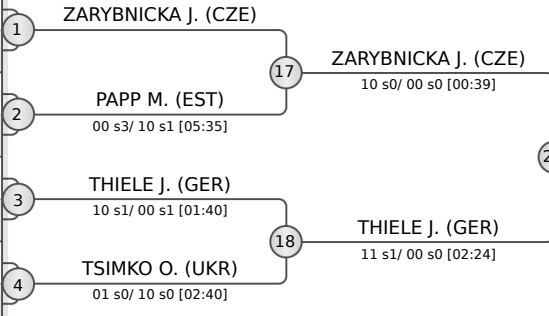

POOL B

JAKOBSEN Ida	DEN
YOUNG Madeleine	GBR
TEPPO Unna	FIN
RYTSKA Mariia	UKR
DEPRI Ilona	FRA
NUIJTEN Kaylie	NED

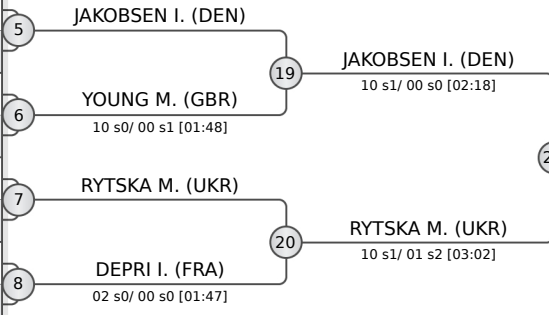

POOL C

KOWALEWSKA Aleksandra	POL
KAYA Sumeyye	TUR
TOCCI Rossana	ITA
PLOEGER Annemarijne	NED
FIZELOVA Ema	SVK
CHABAL Mathilde	FRA
GANZA Jana	GER

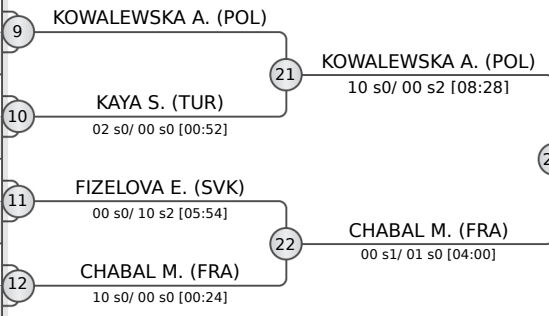

POOL D

PILECKAITE Ugne	LTU
VIDENEIEVA Alisa	UKR
SPEROTTI Claudia	ITA
SWINKELS Nadia	NED
KOTO Rumeysa	TUR
NARVA Anni-Olivia	FIN
MEYER Camille	FRA

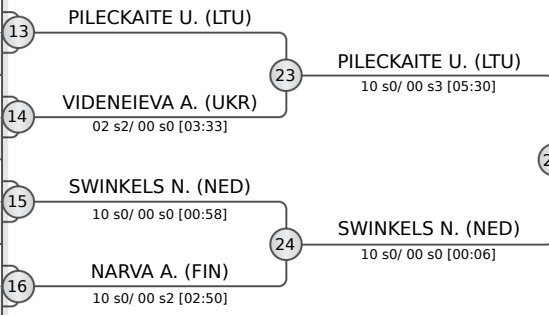

REPECHAGE

PAPP M. (EST)	29	PAPP M. (EST)	33
YOUNG M. (GBR)	30	THIELE J. (GER)	34
GANZA J. (GER)	31	RYTSKA M. (UKR)	35
FIZELOVA E. (SVK)	32	KOWALEWSKA A. (POL)	36
KOTO R. (TUR)		NARVA A. (FIN)	
NARVA A. (FIN)		PILECKAITE U. (LTU)	

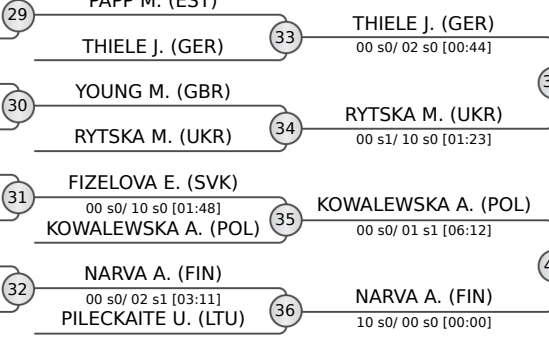

SWINKELS N. (NED) 43

SWINKELS N. (NED) 38

FINAL RESULTS	
1. SWINKELS Nadia	NED
2. JAKOBSEN Ida	DEN
3. CHABAL Mathilde	FRA
3. ZARYBNICKA Julie	CZE
5. RYTSKA Mariia	UKR
5. NARVA Anni-Olivia	FIN
7. THIELE Jenna	GER
7. KOWALEWSKA Aleksandra	POL





Poznan Junior European Cup 2023

Poland, Poznan, 15-16 Apr 2023

-78 kg
Juniors (21)

POOL A

	TUREK Aleksandra	POL
	TCHUMAMO Emeraude	FRA
	AMIRLI Narmin	AZE
	CICEK Seyda Nur	TUR
	NUNWEILER Mia	GER

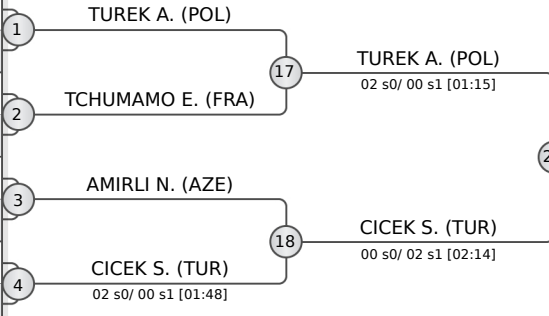

POOL B

	LUDEMA Berber	NED
	BASKUT Elif	TUR
	MAUD Romane	FRA
	KLEINLUGTENBELT Esther	NED
	KRAPU Emma	FIN
	SZANIAWSKA Martyna	POL

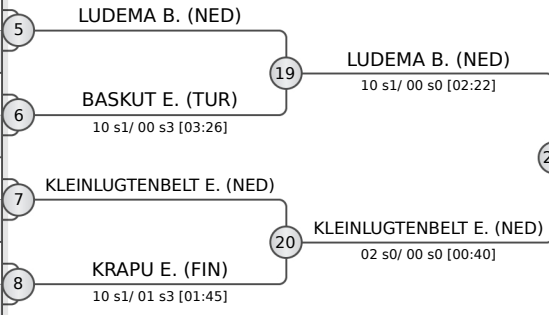

POOL C

	OMERKOYLU Jade	NED
	KUZMA-EBEL Dominika	POL
	GIUSTI Eleonora	ITA
	AGAC Gulsum	TUR
	LANSKIN Thais	FRA

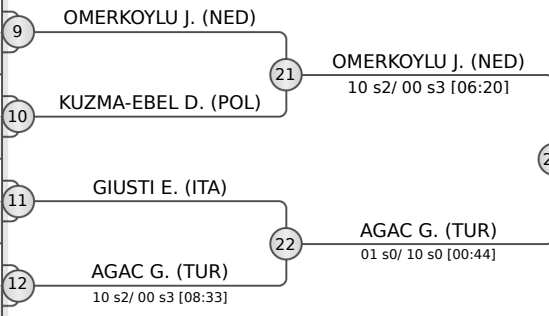

POOL D

	MUSZYNSKA Paulina	POL
	AHUELIE Oceane	FRA
	HANSTEDE Linde	NED
	KAZAKOVA Anna	UKR
	KORKMAZ Gizem	TUR

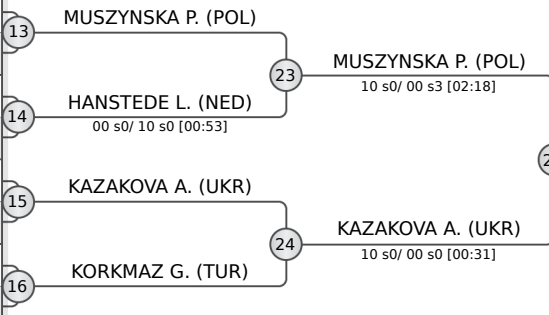

REPECHAGE

NUNWEILER M. (GER)	29	AMIRLI N. (AZE)	30	BASKUT E. (TUR)	31	KORKMAZ G. (TUR)	32
AMIRLI N. (AZE)	33	BASKUT E. (TUR)	34	LANSKIN T. (FRA)	35	MUSZYNSKA P. (POL)	36
TUREK A. (POL)		KLEINLUGTENBELT E. (NED)		OMERKOYLU J. (NED)			

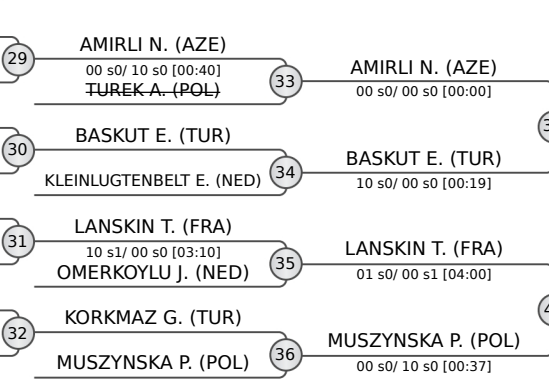

KAZAKOVA A. (UKR) [00:27] → 43

KAZAKOVA A. (UKR) [03:53] → 38

1.	KAZAKOVA Anna	UKR
2.	CICEK Seyda Nur	TUR
3.	AMIRLI Narmin	AZE
3.	LUDEMA Berber	NED
5.	AGAC Gulsum	TUR
7.	LANSKIN Thais	FRA
7.	MUSZYNSKA Paulina	POL





Poznan Junior European Cup 2023

Poland, Poznan, 15-16 Apr 2023

+78 kg

Juniors (11)

POOL A

	MARINI Tiziana	ITA
	IN Ayben	TUR
	KUESTER Amani	GER

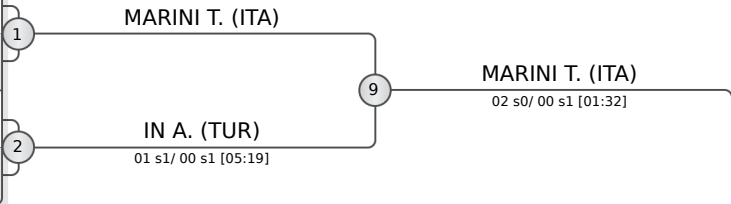

POOL B

	ZOBACASI Exaucee	FRA
	EFE Oznur	TUR

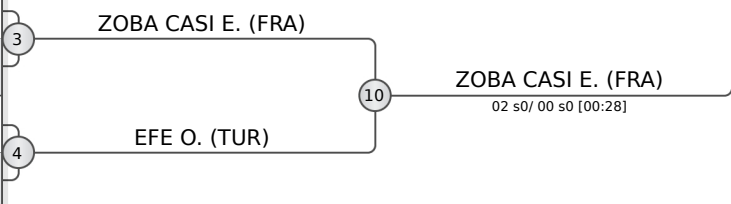

POOL C

	DIRGEN Duygu	TUR
	BOUVIER Gabrielle	BEL
	SULEYMANOVA Nigar	AZE

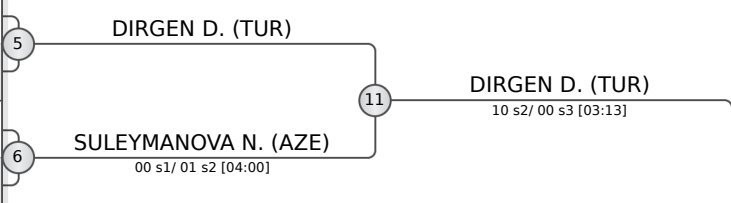

POOL D

	YILMAZ Yagmur	TUR
	DAGHARI Israa	FRA
	STASIULYTE Rugile	LTU

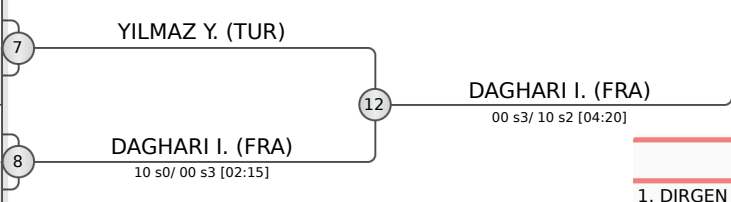

FINAL RESULTS		
1.	DIRGEN Duygu	TUR
2.	ZOBACASI Exaucee	FRA
3.	EFE Oznur	TUR
3.	MARINI Tiziana	ITA
5.	DAGHARI Israa	FRA
5.	STASIULYTE Rugile	LTU
7.	IN Ayben	TUR
7.	SULEYMANOVA Nigar	AZE

REPECHAGE

13	IN A. (TUR)
14	EFE O. (TUR)
15	SULEYMANOVA N. (AZE)
16	STASIULYTE R. (LTU)
16	YILMAZ Y. (TUR)

