



# Bielsko-Biala Cadet European Cup 2023

Poland, Bielsko-Biala, 20-21 May 2023

## -50 kg

Cadets (50)

POOL A

1	MAMISHOV M. (AZE)	33	MAMISHOV M. (AZE)	
2	TURILOV O. (UKR)	00 s3/ 10 s0 [03:21]	49	MAMISHOV M. (AZE)
3	MILOSEVIC A. (SRB)	00 s0/ 01 s1 [04:00]	34	SANTANA J. (BRA)
4	SANTANA J. (BRA)	00 s2/ 01 s0 [04:17]	57	MAMISHOV M. (AZE)
5	TROFYMOV I. (UKR)	35	ISAYEV A. (BEL)	
6	ISAYEV A. (BEL)	02 s0/ 00 s0 [01:56]	50	GRUBER M. (GER)
7	BLACHNIO B. (POL)	00 s0/ 10 s0 [01:11]	36	GRUBER M. (GER)
8	GRUBER M. (GER)	00 s2/ 10 s1 [04:58]	51	ASKAR N. (KAZ)
	SAAKYAN Alexandre (FRA)	10 s0/ 00 s0 [00:26]	52	SILVA V. (BRA)

POOL B

9	ASKAR N. (KAZ)	37	ASKAR N. (KAZ)	
10	MICHALAK W. (POL)	10 s0/ 00 s0 [00:48]	51	ASKAR N. (KAZ)
11	MUSIN D. (UKR)	02 s0/ 00 s0 [01:32]	38	JAKUBAUSKAS A. (LTU)
12	JAKUBAUSKAS A. (LTU)	00 s2/ 10 s0 [04:00]	58	SILVA V. (BRA)
13	CHATTI A. (FRA)	39	CHATTI A. (FRA)	
14	ZWIERS T. (NED)	00 s3/ 10 s0 [01:37]	52	SILVA V. (BRA)
15	SILVA V. (BRA)	00 s0/ 10 s0 [00:11]	40	SILVA V. (BRA)
16	BUETTNER W. (GER)	10 s0/ 00 s1 [02:27]	79	SYZDYK Y. (KAZ)

POOL C

17	SYZDYK Y. (KAZ)	41	SYZDYK Y. (KAZ)	
18	SASSI T. (ITA)	00 s0/ 10 s0 [00:26]	53	SYZDYK Y. (KAZ)
19	ODOR N. (HUN)	00 s3/ 10 s0 [03:00]	42	MUNIZ ACOSTA J. (POL)
20	MUNIZ ACOSTA J. (POL)	00 s1/ 10 s0 [02:44]	59	SYZDYK Y. (KAZ)
21	MAMISHOV N. (AZE)	43	MAMISHOV N. (AZE)	
22	PEETERS M. (BEL)	00 s0/ 01 s0 [04:00]	54	GLASER J. (GER)
23	GLASER J. (GER)	00 s1/ 10 s0 [02:21]	44	GLASER J. (GER)
24	BUTUCI K. (CRO)	02 s0/ 00 s0 [01:40]	74	SYZDYK Y. (KAZ)

POOL D

25	GALO B. (HUN)	45	RUSTAMOV A. (AZE)	
26	RUSTAMOV A. (AZE)	10 s0/ 00 s0 [00:33]	55	RUSTAMOV A. (AZE)
27	BUWALDA R. (NED)	10 s0/ 00 s3 [04:49]	46	CORI S. (SUI)
28	CORI S. (SUI)	00 s0/ 10 s0 [00:44]	60	RUSTAMOV A. (AZE)
29	LEBRETON P. (FRA)	47	MENDES G. (BRA)	
30	MENDES G. (BRA)	00 s0/ 11 s0 [02:49]	56	MENDES G. (BRA)
31	PANAIT A. (ROU)	00 s1/ 10 s0 [00:15]	48	MARKOZASHVILI I. (GEO)
32	MARKOZASHVILI I. (GEO)	00 s1/ 10 s0 [01:57]	61	TURILOV O. (UKR)

REPECHAGE

61	TURILOV O. (UKR)	65	SANTANA J. (BRA)
62	BUETTNER W. (GER)	66	BUETTNER W. (GER)
63	SASSI T. (ITA)	67	SASSI T. (ITA)
64	GALO B. (HUN)	68	CORI S. (SUI)
65	SANTANA J. (BRA)	69	SANTANA J. (BRA)
66	BUETTNER W. (GER)	70	ASKAR N. (KAZ)
67	MUNIZ ACOSTA J. (POL)	71	SASSI T. (ITA)
68	CORI S. (SUI)	72	CORI S. (SUI)
69	SANTANA J. (BRA)	73	SILVA V. (BRA)
70	ASKAR N. (KAZ)	74	SYZDYK Y. (KAZ)
71	SASSI T. (ITA)	75	SANTANA J. (BRA)
72	CORI S. (SUI)	76	SASSI T. (ITA)
73	SILVA V. (BRA)	77	RUSTAMOV A. (AZE)
74	SYZDYK Y. (KAZ)	78	MAMISHOV M. (AZE)

FINAL RESULTS	
1.	SYZDYK Yerbolat KAZ
2.	SILVA Victor Hugo BRA
3.	RUSTAMOV Ahmad AZE
3.	MAMISHOV Mahammad AZE
5.	SANTANA Joao Gabriel BRA
5.	SASSI Thomas ITA
7.	ASKAR Nurbol KAZ
7.	CORI Silvano SUI



# Bielsko-Biala Cadet European Cup 2023

Poland, Bielsko-Biala, 20-21 May 2023

## -55 kg

Cadets (47)

POOL A

ISATAEV Nurlan	KAZ	1
SWITALA Pawel	POL	2
ZIMINAS Orestas	LTU	3
AVRAMENKO Danylo	UKR	4
NOUFAL Mohamed	NED	5
OMANADZE Luka	GEO	6
JORGIC Marko	SRB	7
DECLERCQ Andreas	BEL	8
MACHADO Renzo	BRA	9
TOMASIC Mateo	CRO	10
ZDANOWSKI Konrad	POL	11

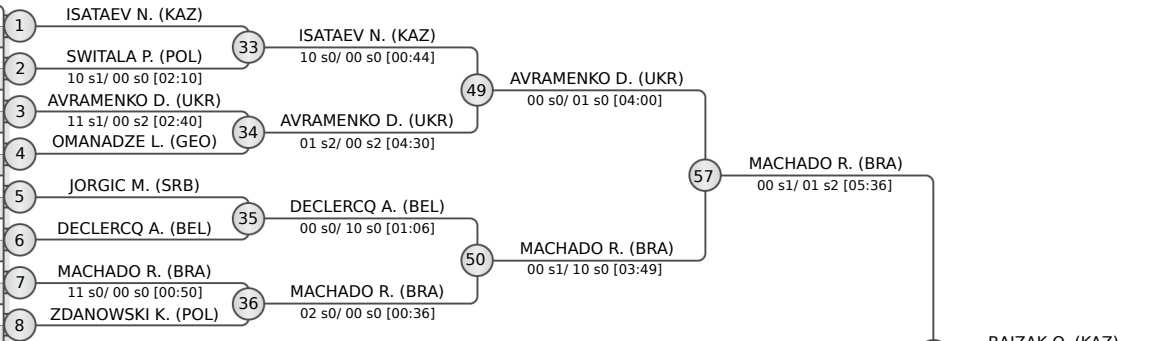

POOL B

BAIZAK Oralbek	KAZ	9
HOMKA Eriks	LAT	10
ADAMOSZEK Bartosz	POL	11
VARNICIC Veljko	SRB	12
MUNTSUROV Mohamed	AUT	13
SOETE Valere	FRA	14
BLAZIC Gal	SLO	15
MIHAYLOV Boris	BUL	16
PERGEL Tamas	HUN	17
KUPPER David	GER	18
JUSKOWIAK Marcin	POL	19
BAUD Romain	SUI	20

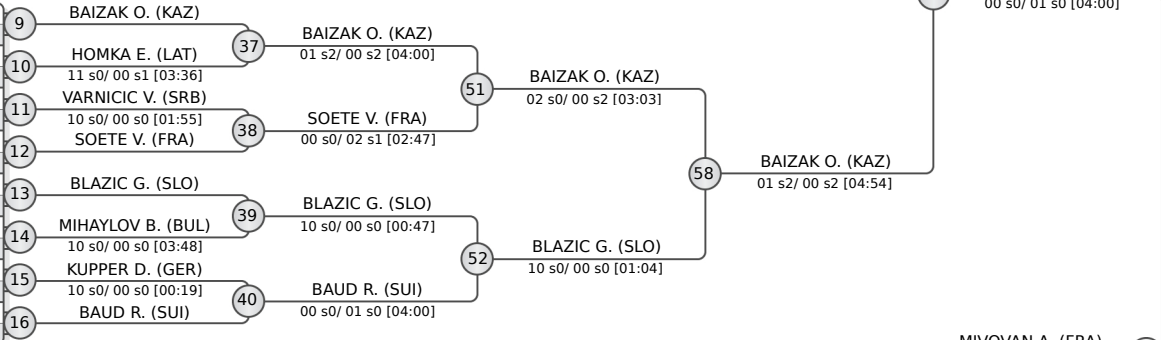

POOL C

MICHALAK Franciszek	POL	17
NAGIMULIN Alihan	GER	18
DIDZIAKIS Dominykas	LTU	19
BJELIC Nemanja	SRB	20
SILVA Samuel	BRA	21
MURAT Yerkhan	KAZ	22
MALETS Nikita	UKR	23
HERTA David	MDA	24
KOLONDRJA Jan	POL	25
FEKE Adam	HUN	26
BIRKHANS Toms Kristians	LAT	27
CIAVURRO Niccolo	ITA	28

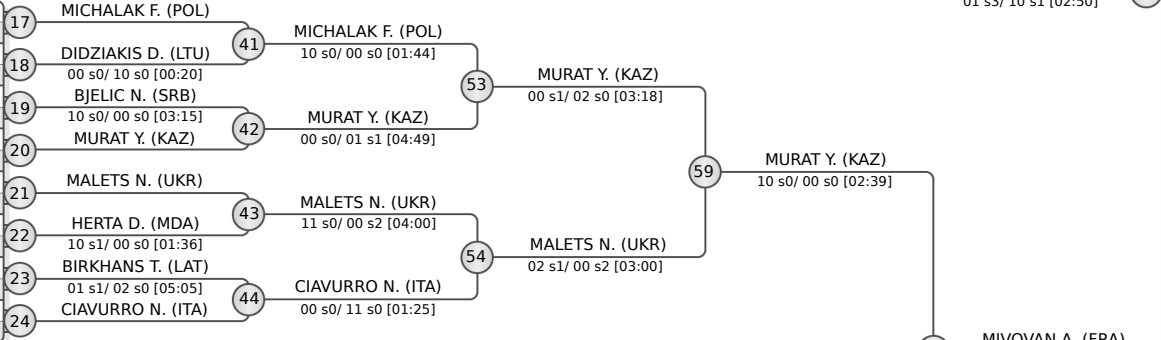

POOL D

MIVOVAN Adrian	FRA	25
ZEMLA Patryk	POL	26
ZINK Stepan	CZE	27
PABERZIS Andrejs	LAT	28
PRYSHCHEPA Andrii	UKR	29
SILVA Marcos	BRA	30
TALON Tiago	FRA	31
KOLOCZEK Jakub	POL	32
JANKOVIC Boris	SRB	33
LEIVA David	USA	34
POBLOCKI Samir	SWE	35
KNEZ Filip	CRO	36

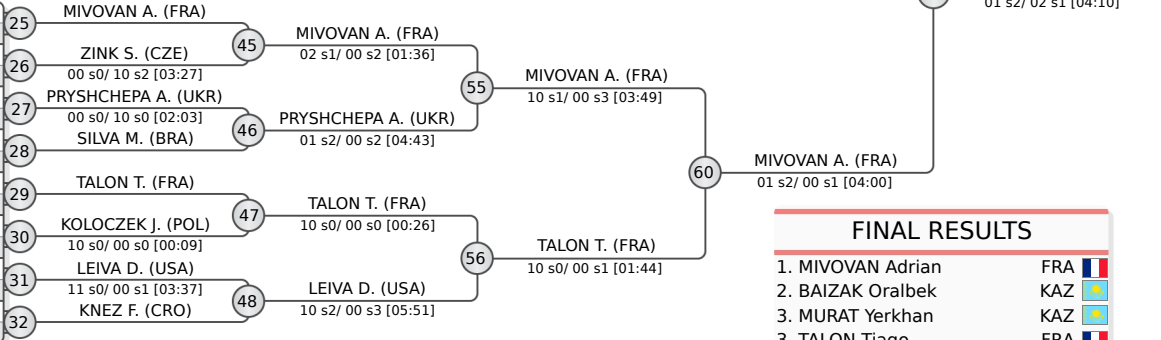

FINAL RESULTS		
1.	MIVOVAN Adrian	FRA
2.	BAIZAK Oralbek	KAZ
3.	MURAT Yerkhan	KAZ
3.	TALON Tiago	FRA
5.	SOETE Valere	FRA
7.	MACHADO Renzo	BRA
7.	AVRAMENKO Danylo	UKR
7.	MALETS Nikita	UKR

REPECHAGE

TOMASIC M. (CRO)	61
ZDANOWSKI K. (POL)	62
HOMKA E. (LAT)	63
BJELIC N. (SRB)	64
ZINK S. (CZE)	65

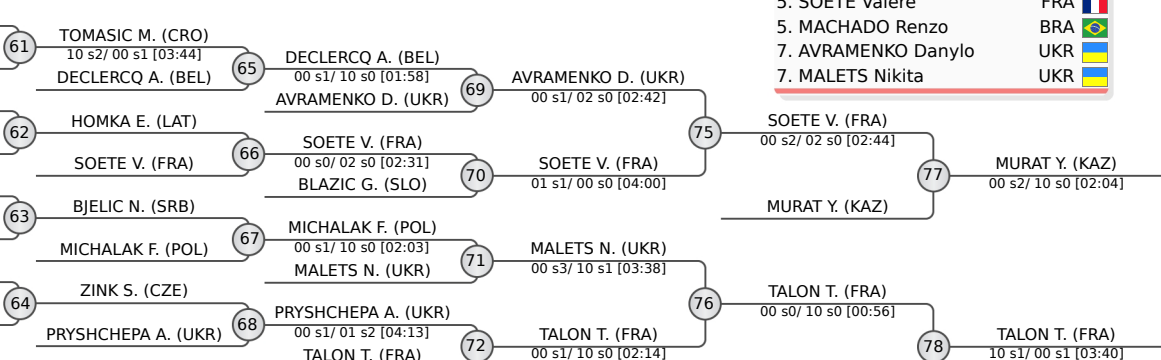



# Bielsko-Biala Cadet European Cup 2023

Poland, Bielsko-Biala, 20-21 May 2023

**-60 kg**  
Cadets (81)

**POOL A**

1	SAGASTEGUI Eduardo (MEX)	1	SAGASTEGUI E. (MEX)
2	RADICS Bendeguz (HUN)	2	RADICS B. (HUN)
3	MANOWSKI Dawid (POL)	3	MANOWSKI D. (POL)
4	KARALEVICIUS Zygimantas (LTU)	4	SAMADASHVILI Merabi (GEO)
5	LYSENKO Vladyslav (UKR)	5	LYSENKO V. (UKR)
6	DE RUITER Twan (NED)	6	DE RUITER T. (NED)
7	PESTEREW Phillip (GER)	7	PESTEREW P. (GER)
8	EISCHEN Xzeno (BEL)	8	HADZI-VELJKOVIC Nikola (CRO)
9	PREDA Alexandru (ROU)	9	PREDA A. (ROU)
10	NOVAK Mario (BIH)	10	KORNATKA K. (POL)
11	KORNATKA Kacper (POL)	11	KOLLAR S. (HUN)
12	KOLLAR Sebestyen (HUN)	12	KATRANIDIS Ioannis (GRE)
13	KATRANIDIS Ioannis (GRE)	13	KASPARAVICIUS Nidijus (LTU)
14	KASPARAVICIUS Nidijus (LTU)	14	MITCHELL Alfie (GBR)
15	MITCHELL Alfie (GBR)	15	LIRA Joao (BRA)
16	LIRA Joao (BRA)	16	AVERSA S. (ITA)
17	AVERSA S. (ITA)	17	DOLZHANSKYI Daniil (UKR)
18	DOLZHANSKYI Daniil (UKR)	18	JANSEN Zef (NED)
19	JANSEN Zef (NED)	19	JANSEN Z. (NED)
20	JANSEN Z. (NED)	20	JANSEN Z. (NED)

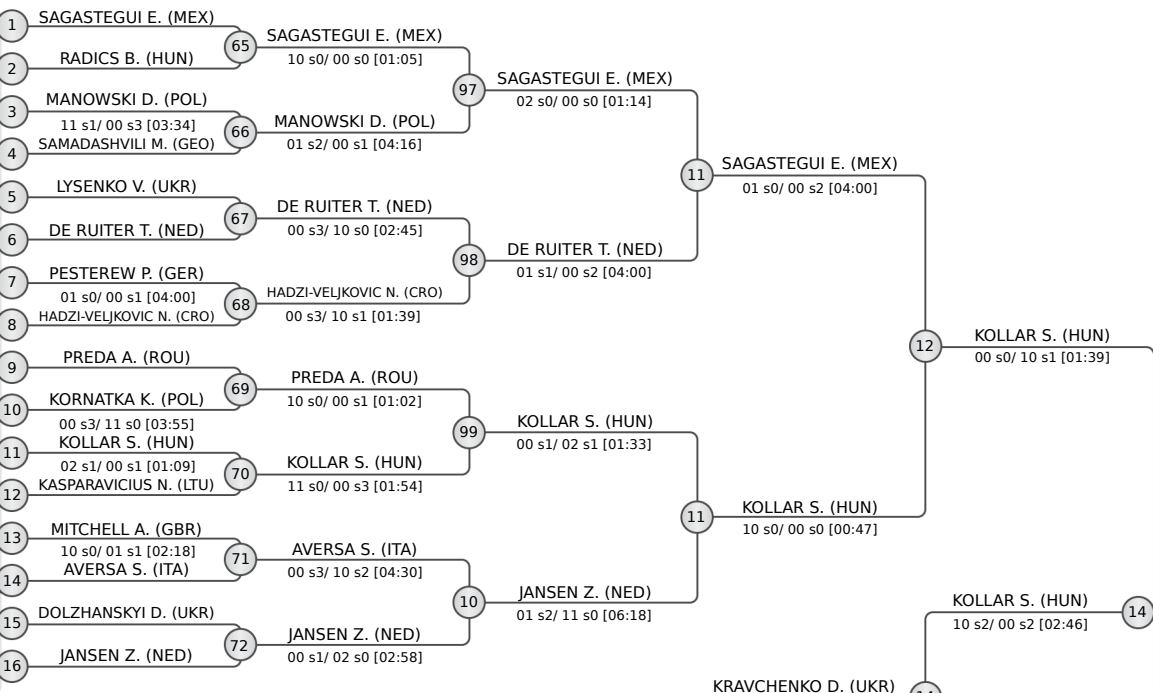

**POOL B**

17	ISKAKOV Nursultan (KAZ)	17	ISKAKOV N. (KAZ)
18	VAN DER KRUK Dinand (NED)	18	COHEN S. (ISR)
19	COHEN Shalev (ISR)	19	JAMAK Ahmed (BIH)
20	JAMAK Ahmed (BIH)	20	NITU Antonio (ROU)
21	NITU Antonio (ROU)	21	RAFFAY Barnabas (HUN)
22	RAFFAY Barnabas (HUN)	22	BETKOWSKI Milosz (POL)
23	BETKOWSKI Milosz (POL)	23	SAVCHENKO Maksym (UKR)
24	SAVCHENKO Maksym (UKR)	24	VAGULIS Danas (LTU)
25	VAGULIS Danas (LTU)	25	TSAPARAS Konstantinos (GRE)
26	TSAPARAS Konstantinos (GRE)	26	NAZARENKO I. (UKR)
27	NAZARENKO I. (UKR)	27	BRISUDA Samuel (SVK)
28	BRISUDA Samuel (SVK)	28	BARSKE Rufus (GER)
29	BARSKE Rufus (GER)	29	SHARIFOV Khanahmad (AZE)
30	SHARIFOV Khanahmad (AZE)	30	GBINGBEHI Johan (FRA)
31	GBINGBEHI Johan (FRA)	31	LIMA Gustavo (BRA)
32	LIMA Gustavo (BRA)	32	BULAJEVS Maksims (LAT)

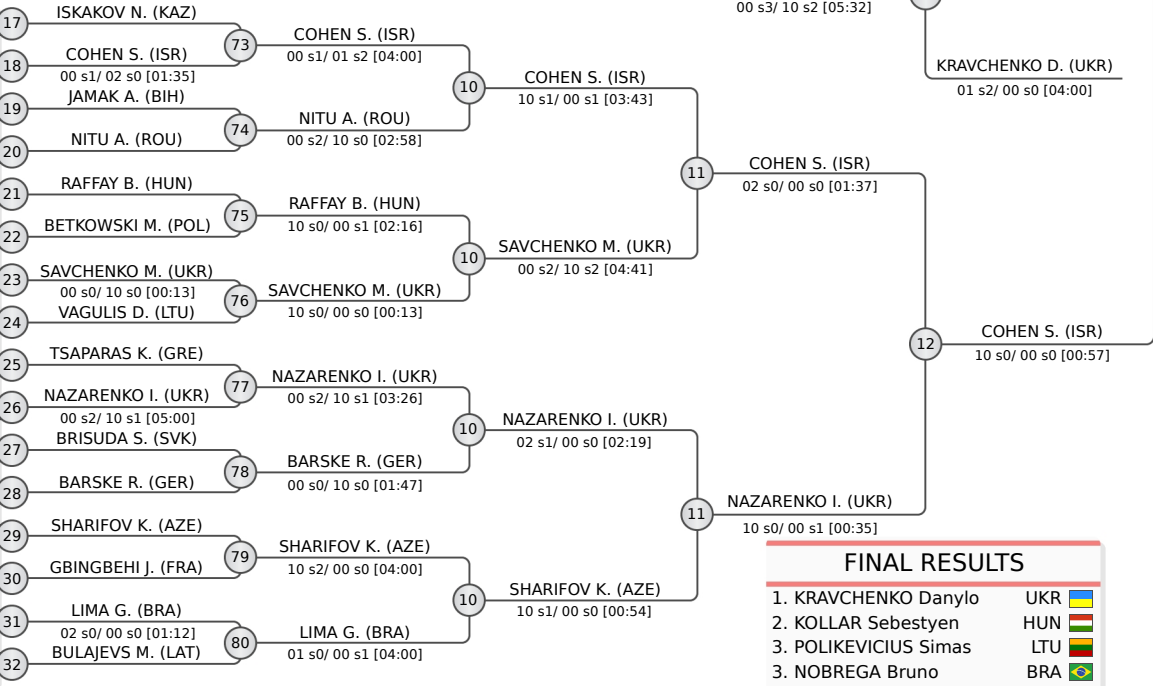

1.	KRAVCHENKO Danylo	UKR
2.	KOLLAR Sebestyen	HUN
3.	POLIKEVICIUS Simas	LTU
3.	NOBREGA Bruno	BRA
5.	JANSEN Zef	NED
5.	COHEN Shalev	ISR
7.	ISKAKOV Nursultan	KAZ
7.	ADRIANO Maxence	FRA

**REPECHAGE**

12	KATRANIDIS I. (GRE)	12	KASPARAVICIUS N. (LTU)
13	KASPARAVICIUS N. (LTU)	13	PREDA A. (ROU)
14	PREDA A. (ROU)	14	ISKAKOV N. (KAZ)
15	ISKAKOV N. (KAZ)	15	NITU A. (ROU)
16	NITU A. (ROU)	16	PALILLO T. (ITA)
17	PALILLO T. (ITA)	17	HOMOLKA J. (CZE)
18	HOMOLKA J. (CZE)	18	ESKANDER A. (NED)
19	ESKANDER A. (NED)	19	OSTAPENKO B. (UKR)
20	OSTAPENKO B. (UKR)	20	DAHAN P. (ISR)
21	DAHAN P. (ISR)	21	ADRIANO M. (FRA)
22	ADRIANO M. (FRA)	22	ADRIANO M. (FRA)

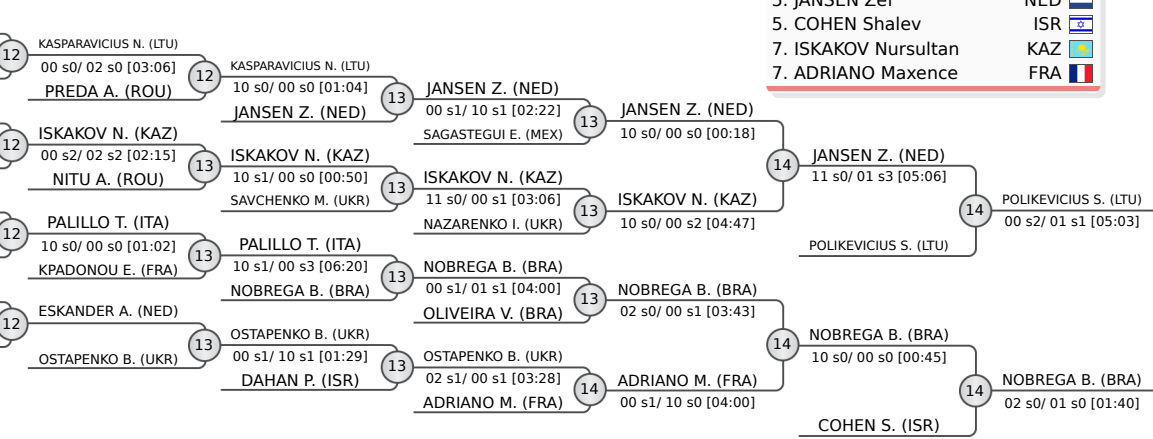



# Bielsko-Biala Cadet European Cup 2023

Poland, Bielsko-Biala, 20-21 May 2023

**-60 kg**  
Cadets (81)

POOL C

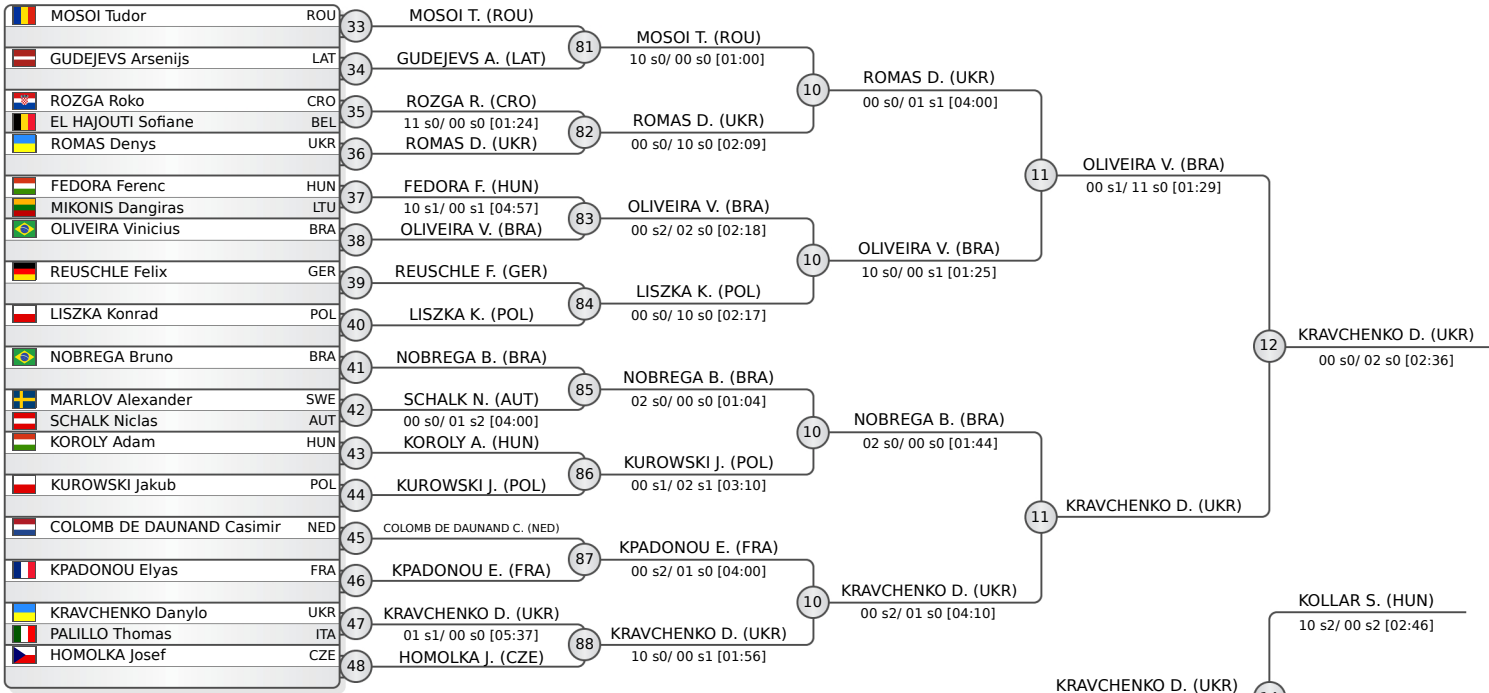

POOL D

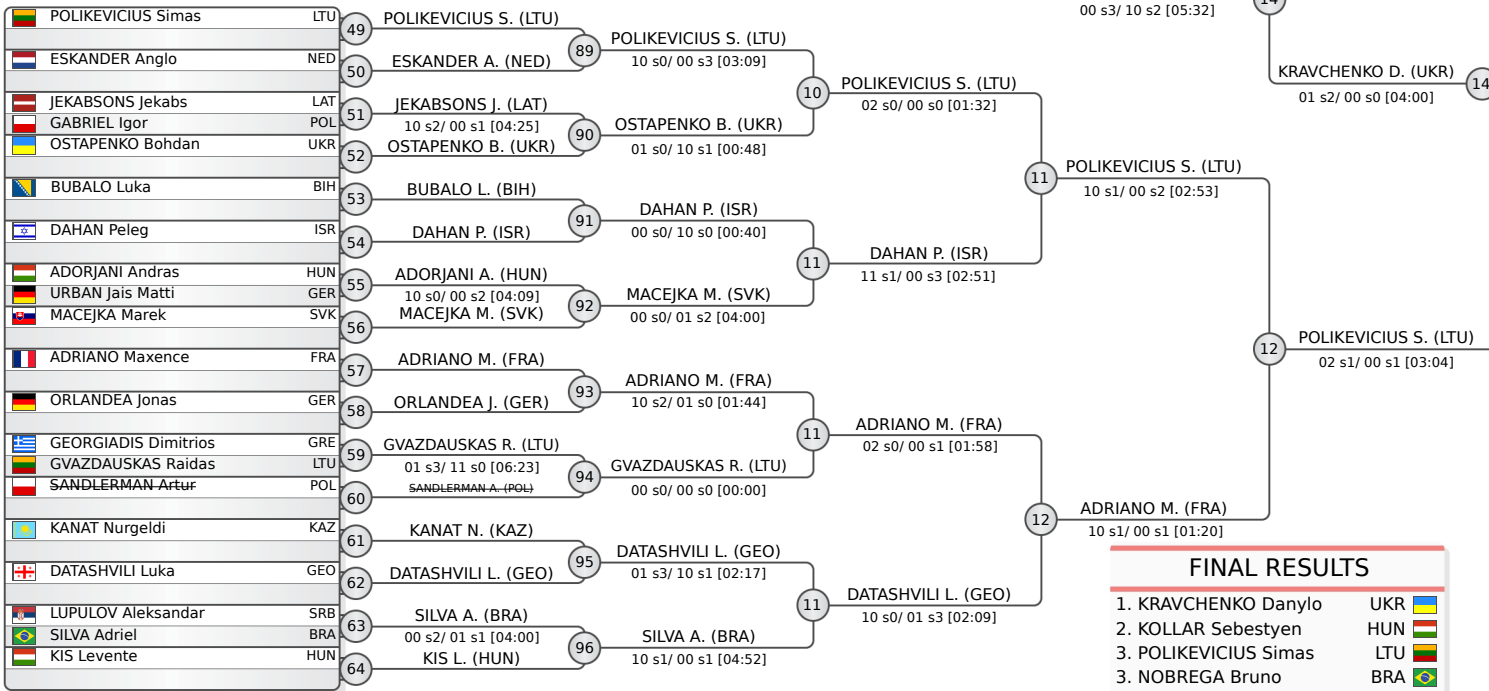

REPECHAGE

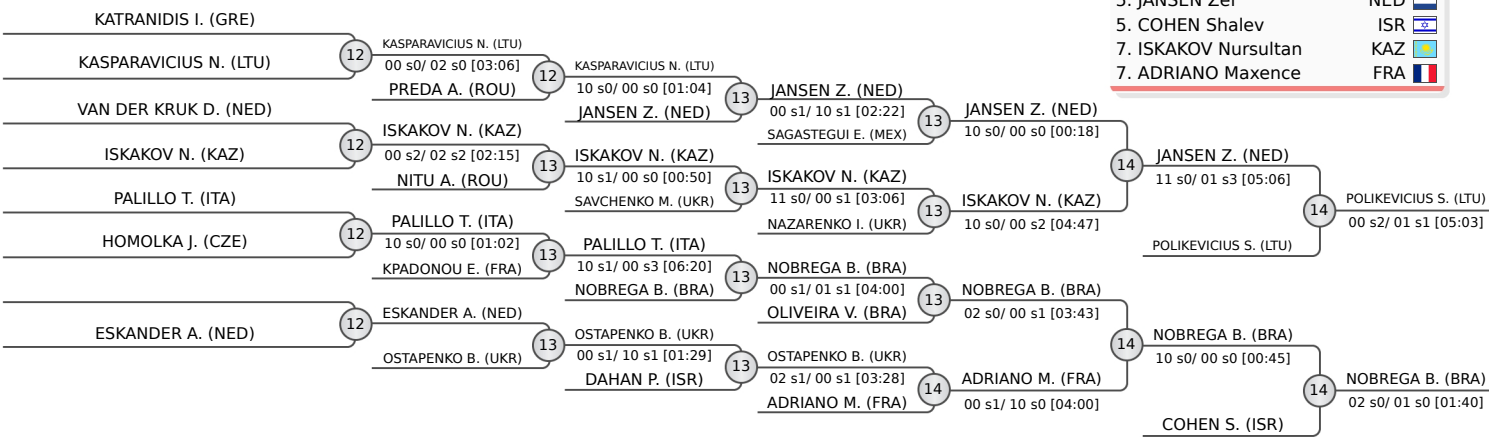

FINAL RESULTS	
1. KRAVCHENKO Danylo	UKR
2. KOLLAR Sebestyen	HUN
3. POLIKEVICIUS Simas	LTU
3. NOBREGA Bruno	BRA
5. JANSEN Zef	NED
5. COHEN Shalev	ISR
7. ISKAKOV Nursultan	KAZ
7. ADRIANO Maxence	FRA





# Bielsko-Biala Cadet European Cup 2023

Poland, Bielsko-Biala, 20-21 May 2023

## -66 kg

Cadets (98)

POOL A

	JAFAROV Mehdi	AZE	1	JAFAROV M. (AZE)
	QUADALTI Filippo	ITA	2	QUADALTI F. (ITA)
	NASCIMENTO Felipe	BRA	3	PROTSENKO V. (UKR)
	PROTSENKO Vladyslav	UKR	4	PROTSENKO V. (UKR)
	STOPP Patrik	HUN	5	SABASHVILI S. (GEO)
	CIHANOVICS Arsenijs	LAT	6	FEDORYK D. (UKR)
	SABASHVILI Saba	GEO	7	FEDORYK D. (UKR)
	GRUBELSKI Jakub	POL	8	CABROL L. (FRA)
	FEDORYK Danylo	UKR	9	MILOVANOVIC N. (CRO)
	CABROL Lilian	FRA	10	GVELESIANI M. (GEO)
	MARTINKA Josef	CZE	11	MILANOVIC V. (SRB)
	MILOVANOVIC Nikola	CRO	12	SHAIMENOV A. (KAZ)
	GVELESIANI Mate	GEO	13	SHAIMENOV A. (KAZ)
	HUSEINOV Mahdi	GBR	14	STEFANSKI A. (POL)
	MILANOVIC Veljko	SRB	15	BALIEV R. (GER)
	BALAMPANIDIS Iraklis	GRE	16	DANISCA V. (MDA)
	SHAIMENOV Akniyet	KAZ	17	JOVSA D. (LTU)
	STEFANSKI Adrian	POL	18	GRENA Tobias
	BALIEV Ramzan	GER	19	CSABEN M. (HUN)
	OLIINYK Artemii	UKR	20	BALIEV R. (GER)
	DANISCA Vladimir	MDA	21	DANISCA V. (MDA)
	GRABNER Erik	AUT	22	JOVSA D. (LTU)
	JOVSA Deividas	LTU	23	GRENA Tobias
	GRENA Tobias	SVK	24	CSABEN M. (HUN)
	CSABEN Marton	HUN	25	CSABEN M. (HUN)

POOL B

	PETROVIC Pavle	SRB	17	PETROVIC P. (SRB)
	NZE BEKALE Kylian	FRA	18	NZE BEKALE K. (FRA)
	RESUTIK Adam	CZE	19	PIATKOWSKI A. (POL)
	PIATKOWSKI Adam	POL	20	PIATKOWSKI A. (POL)
	NIFTULLAIEV Anar	UKR	21	CORLUKA R. (CRO)
	CORLUKA Roko	CRO	22	CORLUKA R. (CRO)
	WOLSFELD Benedict	GER	23	WOLSFELD B. (GER)
	CHOPLIANI Luka	GEO	24	ABAY I. (KAZ)
	ABAY Islam	KAZ	25	ABAY I. (KAZ)
	BICORNGI Alessandro	ITA	26	BICORNGI A. (ITA)
	PIDKIPNYI Glib	UKR	27	BICORNGI A. (ITA)
	KOSZTOR-NEMES Marcell	HUN	28	KOSZTOR-NEMES M. (HUN)
	KATIC Luka	CRO	29	KATIC L. (CRO)
	NUNES DOS SANTOS Kevin	LUX	30	BOJAROVIC A. (LTU)
	BOJAROVIC Artur	LTU	31	BOJAROVIC A. (LTU)
	VAN HUIJSTEE Midas	NED	32	SCHIER F. (BRA)
	SCHIER Francisco	BRA	33	SCHIER F. (BRA)
	KOBYLINSKI Jakub	POL	34	KOBYLINSKI J. (POL)
	BULINGER Eduard	GER	35	BULINGER E. (GER)
	ZAKAJEV Abdul	AUT	36	BULINGER E. (GER)
	DOBROVIC Vojin	MNE	37	DOBROVIC V. (MNE)
	FISER Stepan	CZE	38	AVDEJEVS A. (LAT)
	AVDEJEVS Aleksandrs	LAT	39	AVDEJEVS A. (LAT)
	RUĐENKO Tymofii	UKR	40	RUĐENKO T. (UKR)

REPECHAGE

MILANOVIC V. (SRB)	12	MILANOVIC V. (SRB)	12	SHAIMENOV A. (KAZ)	13	SHAIMENOV A. (KAZ)	13	PROTSENKO V. (UKR)	14	SCHIER F. (BRA)	14	GIVISHVILI G. (GEO)	14	GIVISHVILI G. (GEO)	14	GIVISHVILI G. (GEO)	14	GIVISHVILI G. (GEO)
BOJAROVIC A. (LTU)	12	BOJAROVIC A. (LTU)	12	SCHIER F. (BRA)	13	SCHIER F. (BRA)	13	SCHIER F. (BRA)	14	SCHIER F. (BRA)	14	GIVISHVILI G. (GEO)	14	GIVISHVILI G. (GEO)	14	GIVISHVILI G. (GEO)	14	GIVISHVILI G. (GEO)
SOKIC V. (SRB)	12	SOKIC V. (SRB)	12	SOKIC V. (SRB)	13	SOKIC V. (SRB)	13	SCHIER F. (BRA)	14	SCHIER F. (BRA)	14	GIVISHVILI G. (GEO)	14	GIVISHVILI G. (GEO)	14	GIVISHVILI G. (GEO)	14	GIVISHVILI G. (GEO)
KWIECINSKI A. (POL)	12	KWIECINSKI A. (POL)	12	KISS S. (HUN)	13	KISS S. (HUN)	13	IBADLI J. (AZE)	14	IBADLI J. (AZE)	14	IBADLI J. (AZE)	14	IBADLI J. (AZE)	14	IBADLI J. (AZE)	14	IBADLI J. (AZE)

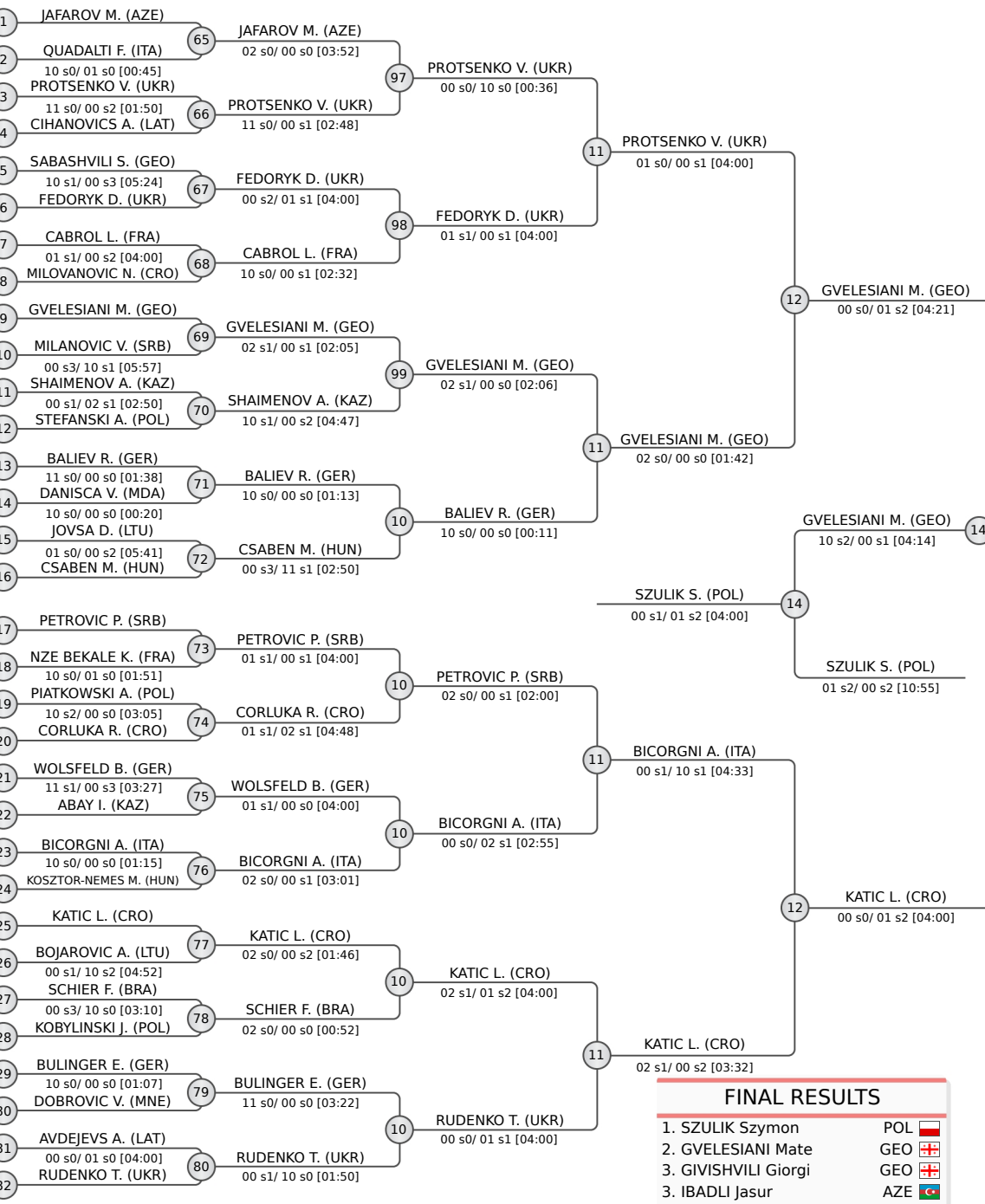

FINAL RESULTS	
1. SZULIK Szymon	POL
2. GVELESIANI Mate	GEO
3. GIVISHVILI Giorgi	GEO
3. IBADLI Jasur	AZE
5. SCHIER Francisco	BRA
5. KATIC Luka	CRO
7. PROTSENKO Vladyslav	UKR
7. ORYNBAEV Erkebulan	KAZ



# Bielsko-Biala Cadet European Cup 2023

Poland, Bielsko-Biala, 20-21 May 2023

**-66 kg**  
Cadets (98)

POOL C

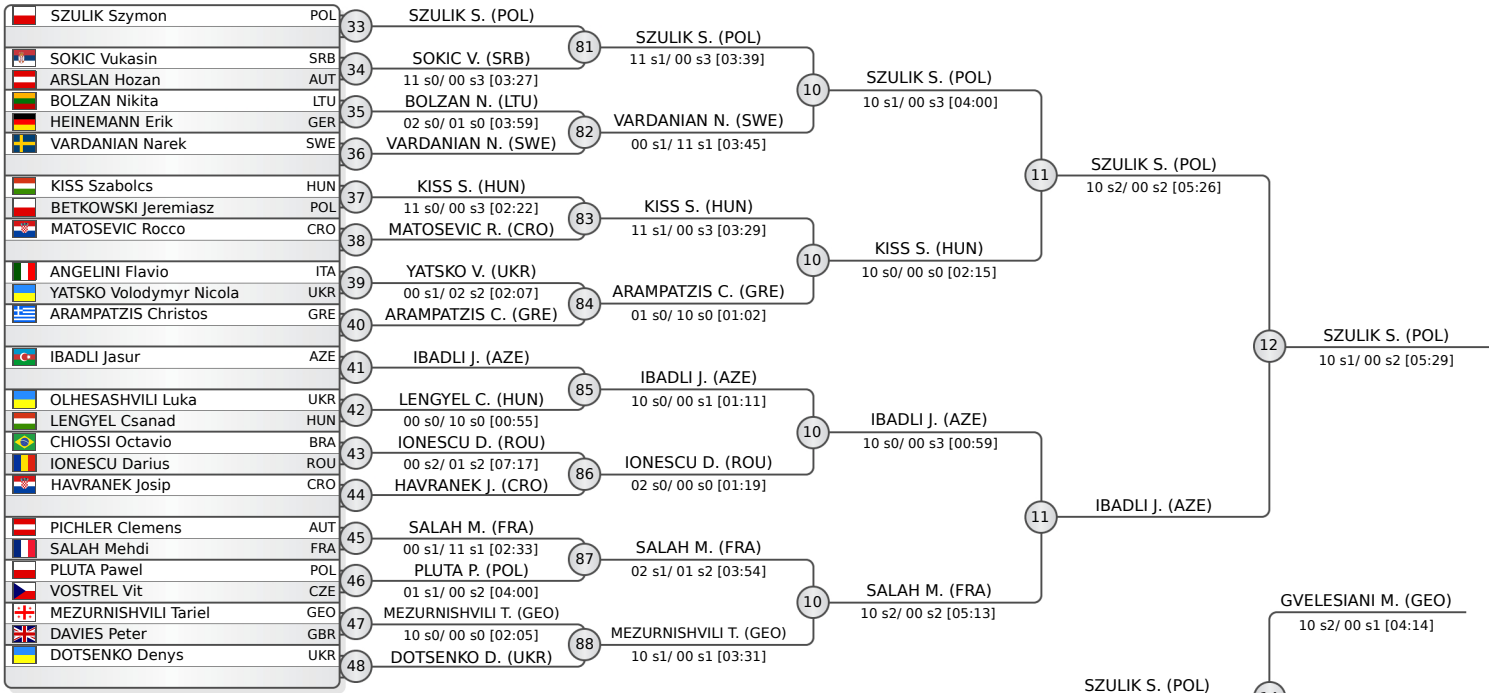

POOL D

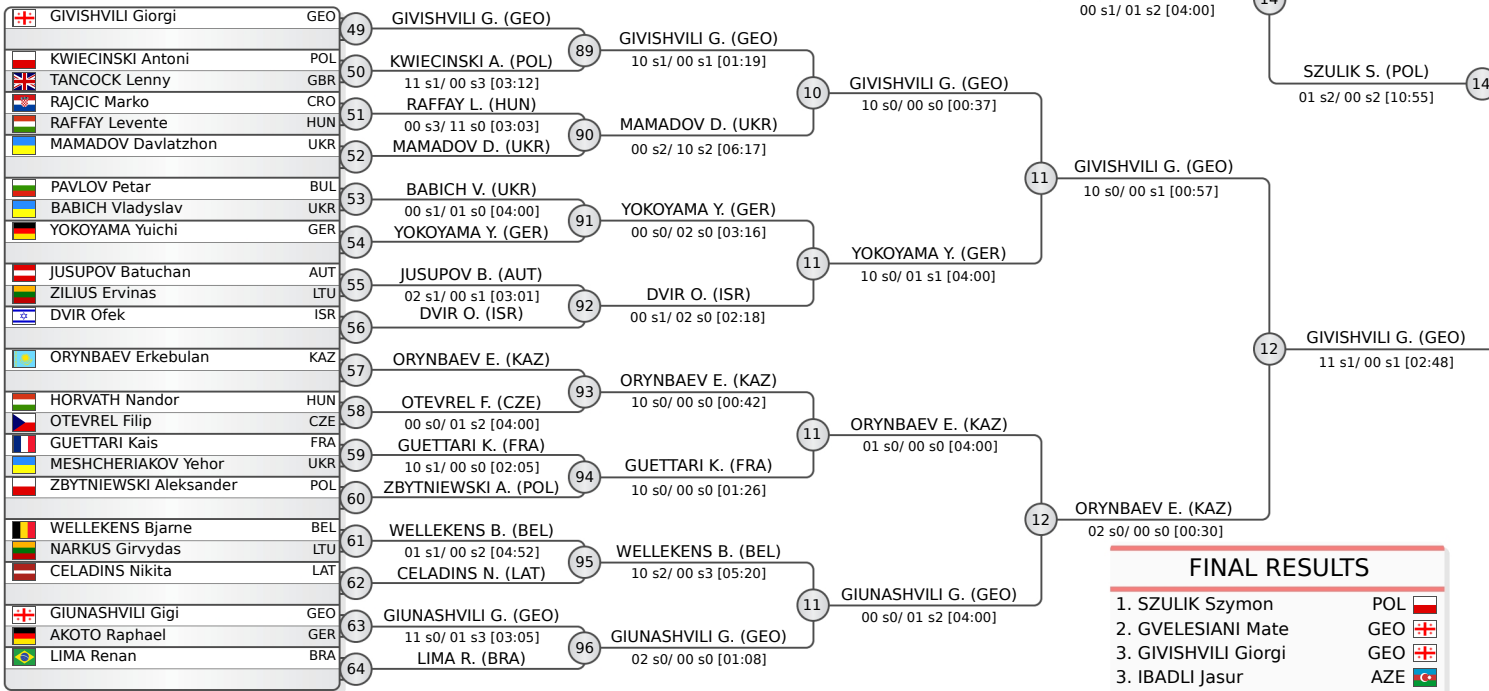

FINAL RESULTS	
1. SZULIK Szymon	POL
2. GVELESIANI Mate	GEO
3. GIVISHVILI Giorgi	GEO
4. IBADLI Jasur	AZE
5. SCHIER Francisco	BRA
6. KATIC Luka	CRO
7. PROTSENKO Vladyslav	UKR
7. ORYNBAEV Erkebulan	KAZ

REPECHAGE

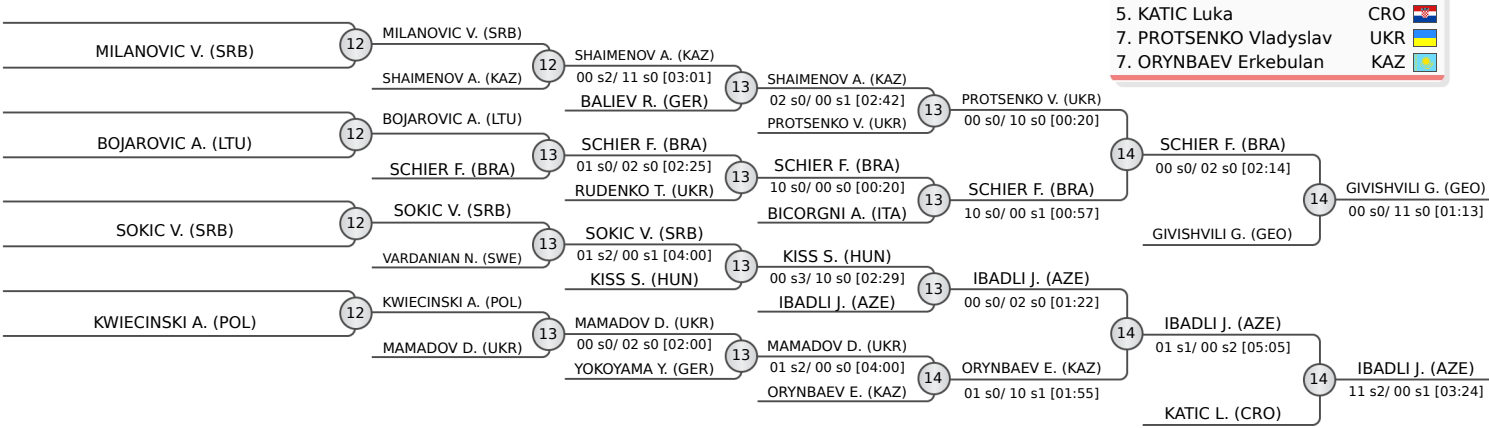



# Bielsko-Biala Cadet European Cup 2023

Poland, Bielsko-Biala, 20-21 May 2023

**-73 kg**  
Cadets (72)

**POOL A**

YERBOLULY Yedil	KAZ	1	YERBOLULY Y. (KAZ)
KRAJCAR Paolo	CRO	2	KRAJCAR P. (CRO)
JELONEK Mateusz	POL	3	JELONEK M. (POL)
FRIEDRICHS Paul	GER	4	FRIEDRICHS P. (GER)
PERISIC Djordje	MNE	5	ZUBOVIC M. (SRB)
ZUBOVIC Mateja	SRB	5	ZUBOVIC M. (SRB)
ELIEV Kharon	FRA	6	ELIEV K. (FRA)
YAKOVENKO Yehor	UKR	7	YAKOVENKO Y. (UKR)
KOCZINSKI Arel	ISR	8	KOCZINSKI A. (ISR)
VAKHTANGADZE Tornike	GEO	9	VAKHTANGADZE T. (GEO)
BRZUSZCZYNSKI Szymon	POL	10	BRZUSZCZYNSKI S. (POL)
SARBOCH Adam	CZE	11	SARBOCH A. (CZE)
LOMONOSOV Niks	LAT	12	LOMONOSOV N. (LAT)
SAAR Karl	EST	13	PINTER B. (HUN)
PINTER Bulcsu	HUN	13	PINTER B. (HUN)
HOPE Isaac	GBR	14	HOPE I. (GBR)
ROEDER Henry	GER	15	ROEDER H. (GER)
COSTA Julio Gabriel	BRA	16	COSTA J. (BRA)

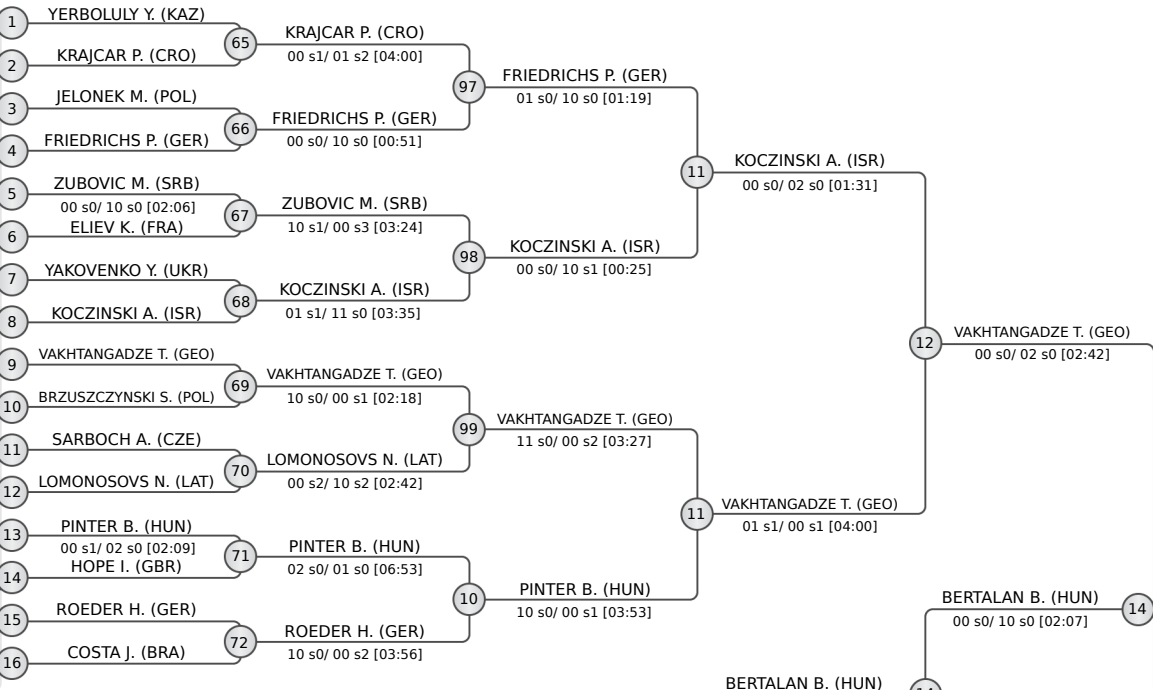

**POOL B**

NIELZIEV Taras	UKR	17	NIELZIEV T. (UKR)
PROELL Michael	AUT	18	PROELL M. (AUT)
MIKLOVIC Samuel	SVK	19	VELICKOVIC B. (SRB)
VELICKOVIC Bogdan	SRB	19	VELICKOVIC B. (SRB)
HASSOUN Alhamzah	BEL	20	HASSOUN A. (BEL)
JOHANEK David	CZE	21	JOHANEK D. (CZE)
KOMIC Oliver	SLO	22	KOMIC O. (SLO)
LIBUDA Jan	GER	23	LIBUDA J. (GER)
PASZEK Damian	POL	24	PASZEK D. (POL)
GLIGA David	ROU	25	GLIGA D. (ROU)
NARKUS Vygidardas	LTU	26	NARKUS V. (LTU)
MUSZYNSKI Jakub	POL	27	IVTCHENKO J. (GER)
IVTCHENKO Josef	GER	27	IVTCHENKO J. (GER)
DEN BROEDER Kuba	NED	28	DEN BROEDER K. (NED)
RADOLOVIC Edvard	CRO	29	RADOLOVIC E. (CRO)
MANFELDS Tomass	LAT	30	MANFELDS T. (LAT)
BERTALAN Balazs	HUN	31	BERTALAN B. (HUN)
LONC Sergiusz	POL	32	LONC S. (POL)

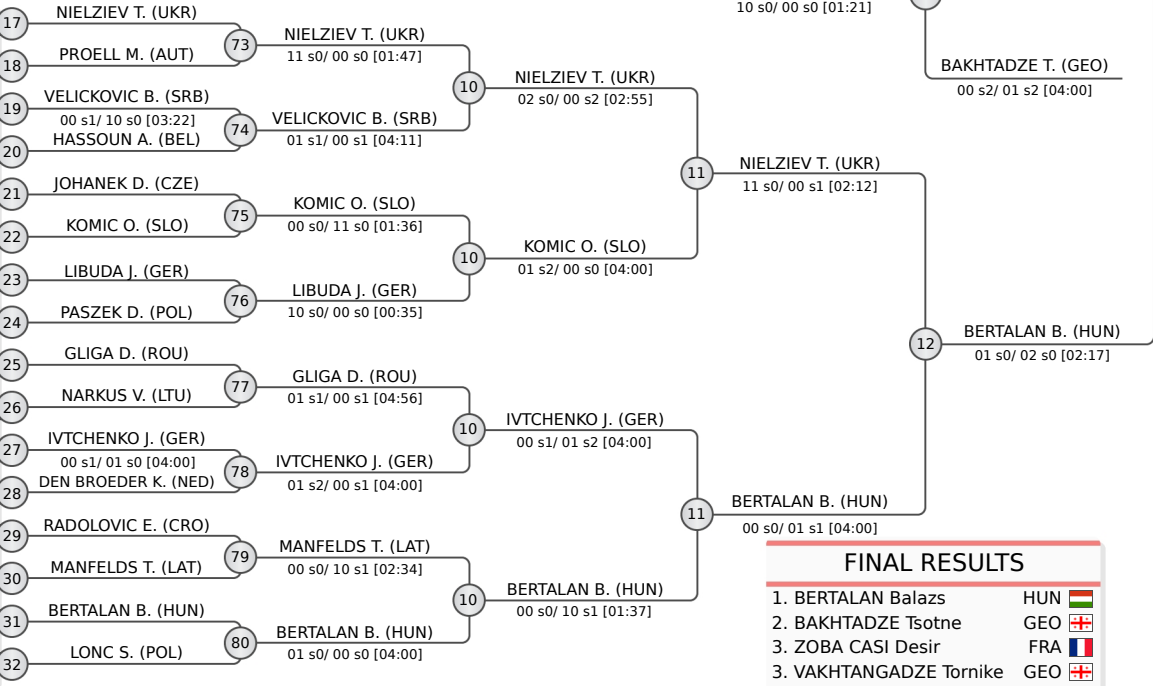

**REPECHAGE**

BRZUSZCZYNSKI S. (POL)	12	BRZUSZCZYNSKI S. (POL)	12
LONC S. (POL)	12	LONC S. (POL)	12
RACKA N. (LTU)	12	RACKA N. (LTU)	12
ARGYNBEK N. (KAZ)	12	ARGYNBEK N. (KAZ)	12

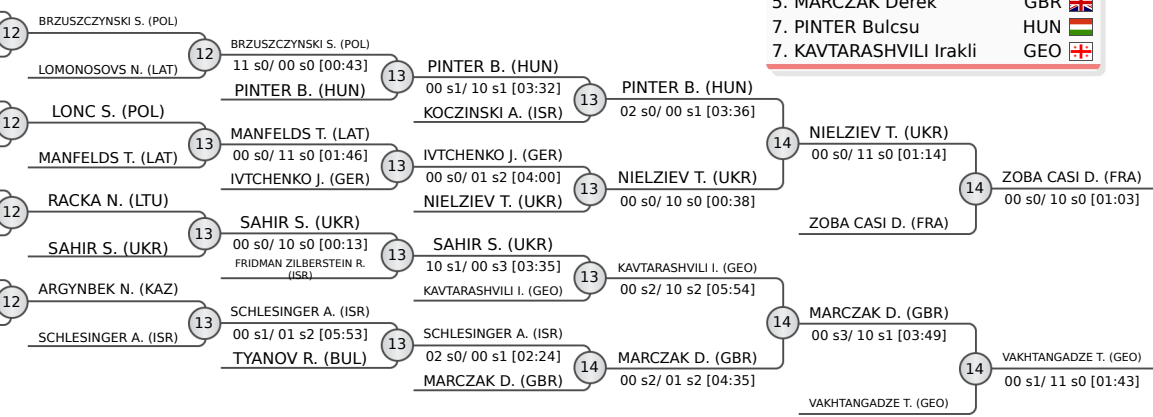

FINAL RESULTS		
1. BERTALAN Balazs	HUN	
2. BAKHTADZE Tsotne	GEO	
3. ZOBAS CASI Desir	FRA	
4. VAKHTANGADZE Tornike	GEO	
5. NIELZIEV Taras	UKR	
6. MARCZAK Derek	GBR	
7. PINTER Bulcsu	HUN	
7. KAVTARASHVILI Irakli	GEO	



# Bielsko-Biala Cadet European Cup 2023

Poland, Bielsko-Biala, 20-21 May 2023

**-73 kg**  
Cadets (72)

POOL C

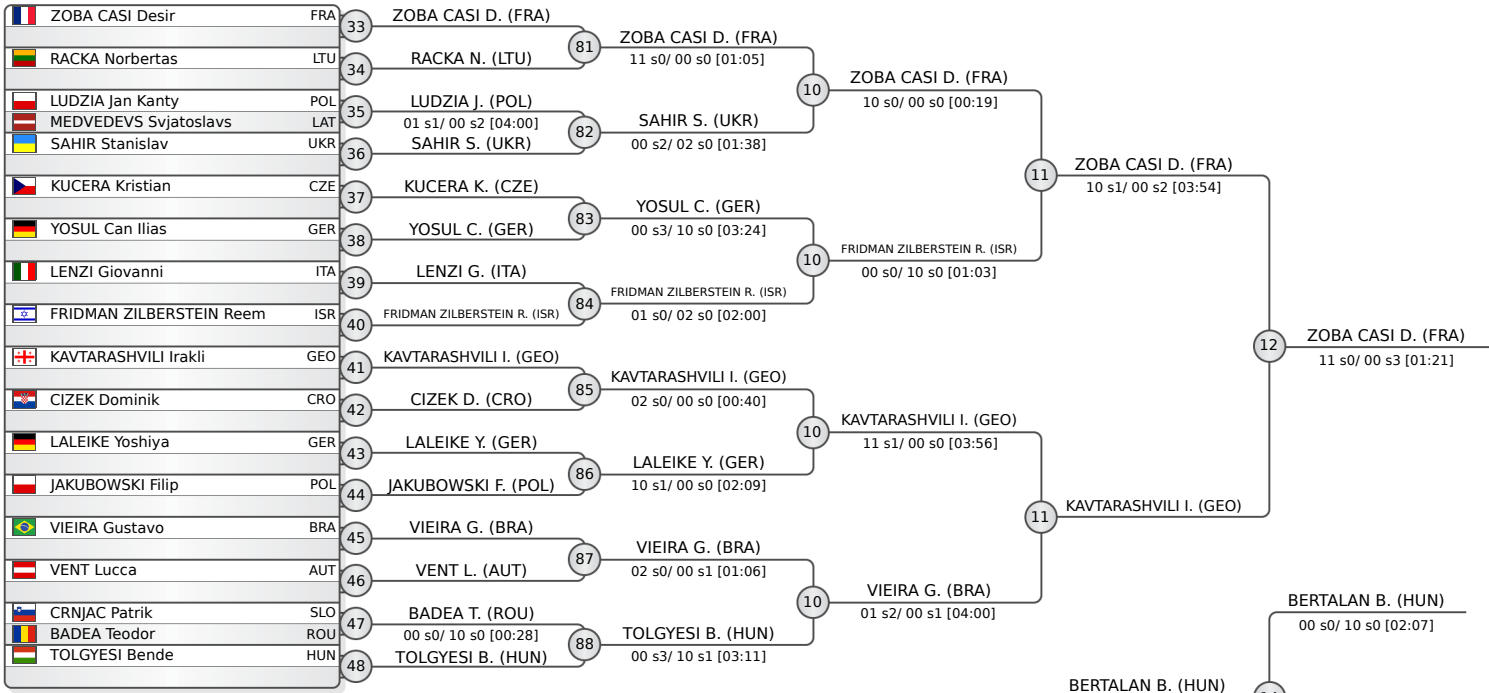

POOL D

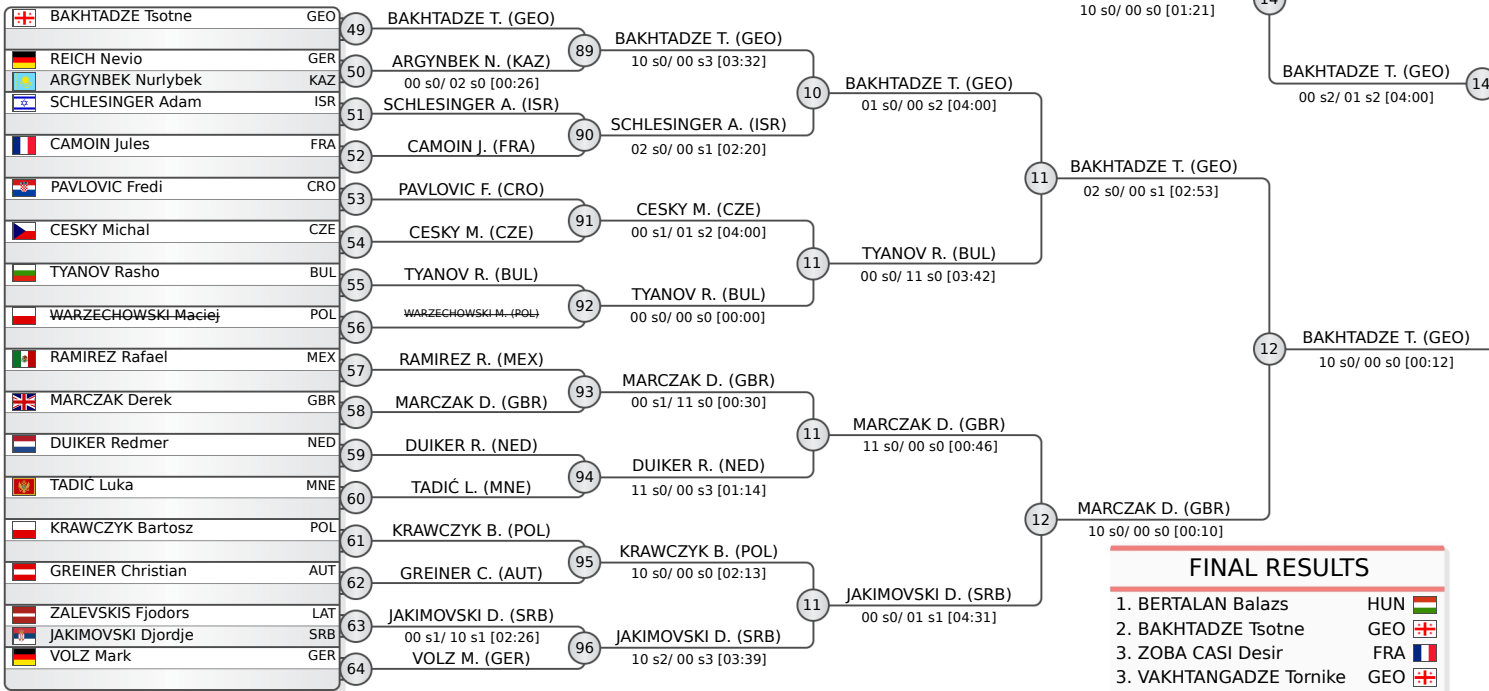

FINAL RESULTS		
1.	BERTALAN Balazs	HUN
2.	BAKHTADZE Tsotne	GEO
3.	ZOBA CASI Desir	FRA
3.	VAKHTANGADZE Tornike	GEO
5.	NIELZIEV Taras	UKR
5.	MARCZAK Derek	GBR
7.	PINTER Bulcsu	HUN
7.	KAVTARASHVILI Irakli	GEO

REPECHAGE

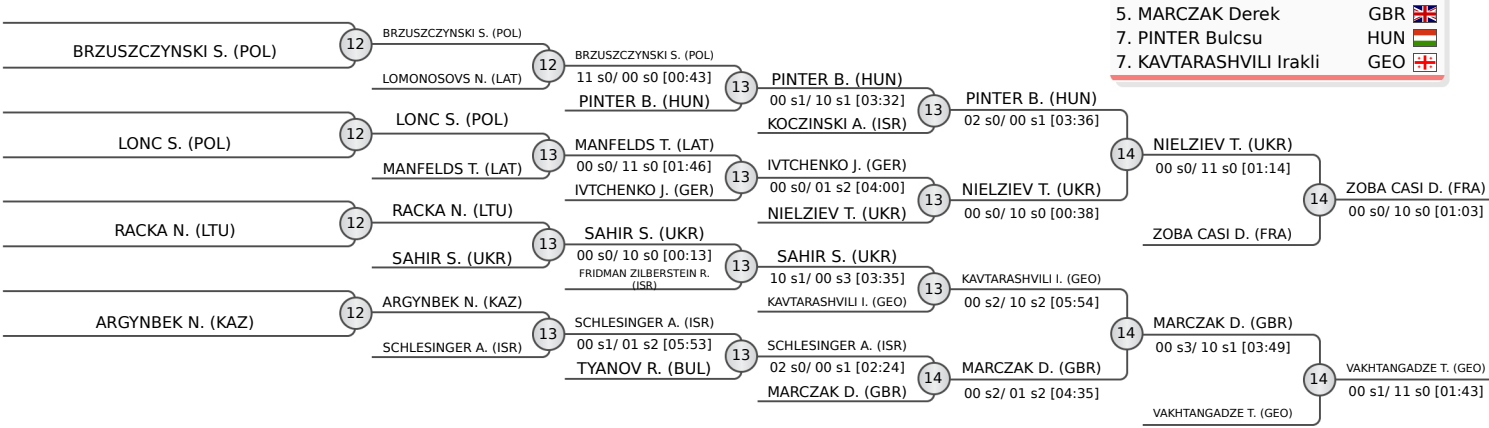





# Bielsko-Biala Cadet European Cup 2023

Poland, Bielsko-Biala, 20-21 May 2023

**-81 kg**  
Cadets (68)

**POOL A**

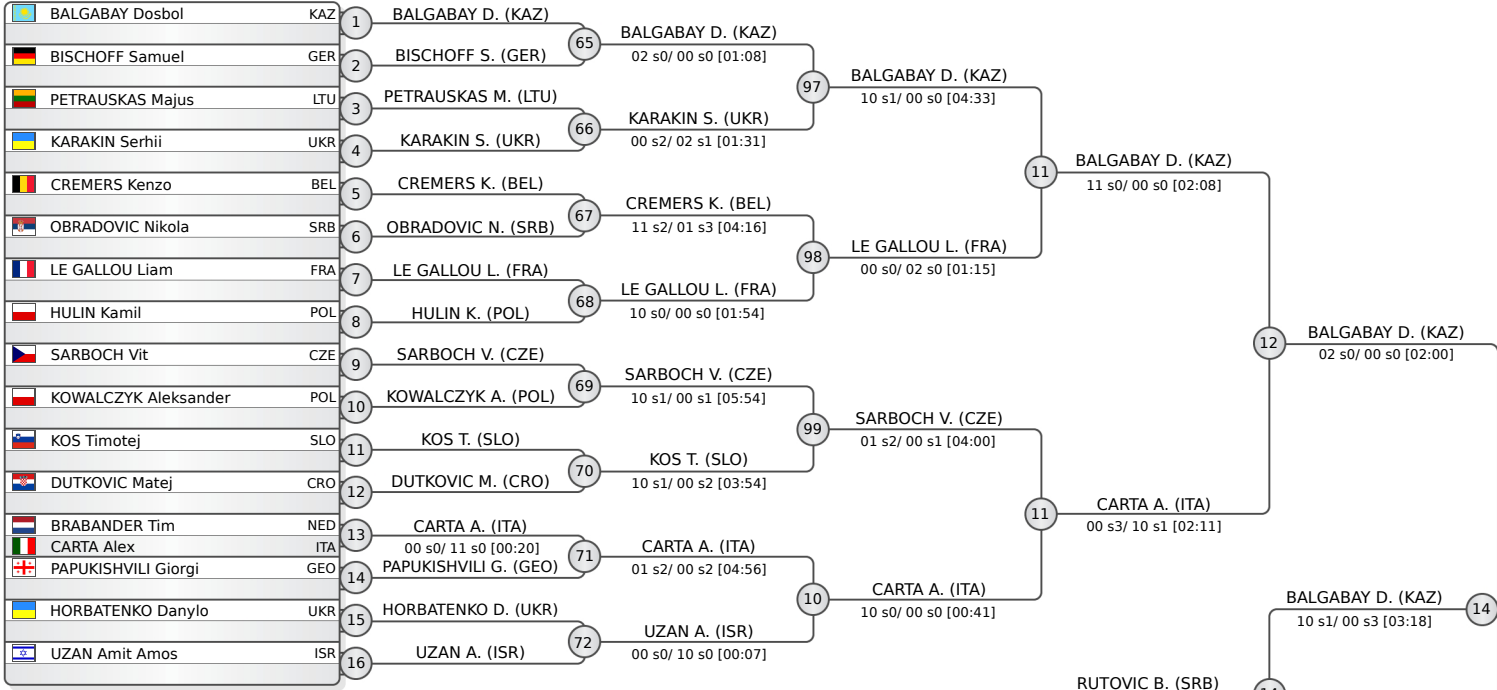

**POOL B**

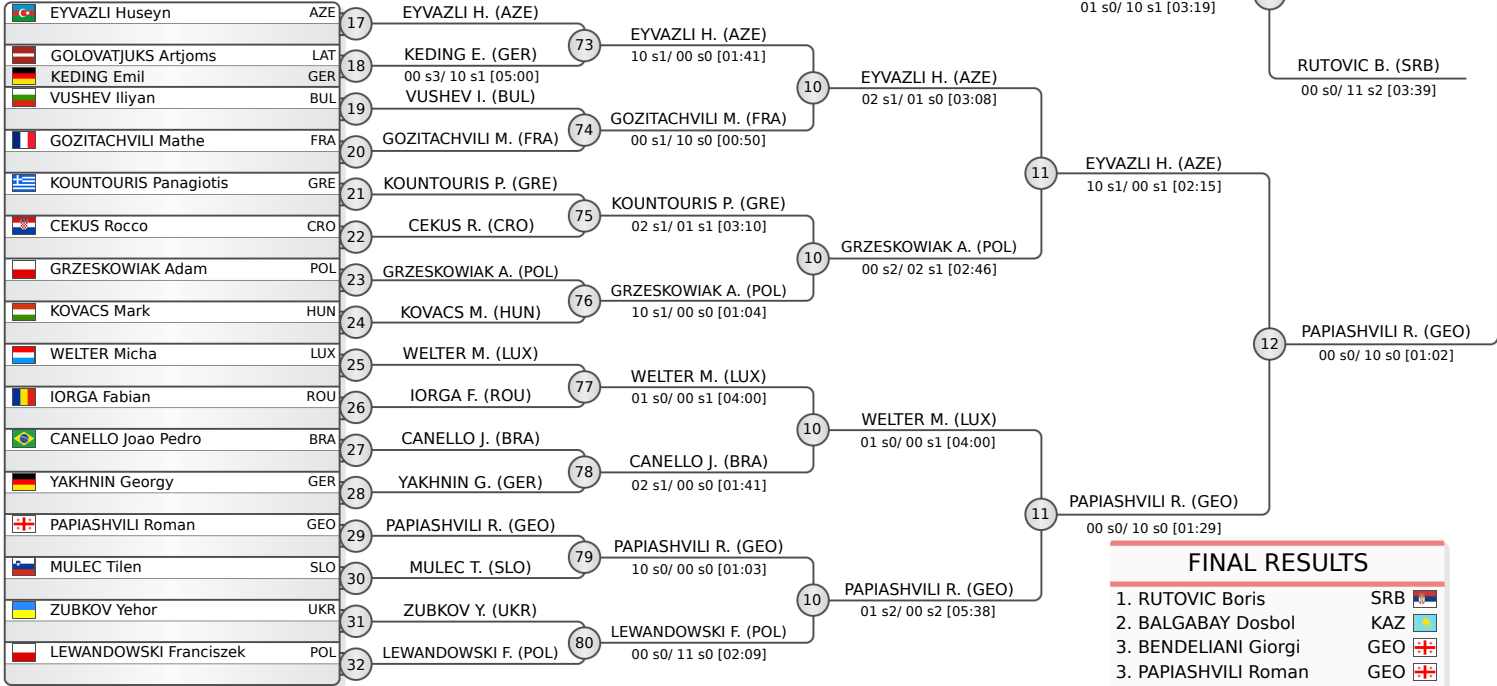

FINAL RESULTS		
1.	RUTOVIC Boris	SRB
2.	BALGABAY Dosbol	KAZ
3.	BENDELIANI Giorgi	GEO
5.	PAPIASHVILI Roman	GEO
5.	LE GALLOU Liam	FRA
5.	BRNADA Ivan	CRO
7.	LEWANDOWSKI Franciszek	POL
7.	GROSMAN Yair	ISR

**REPECHAGE**

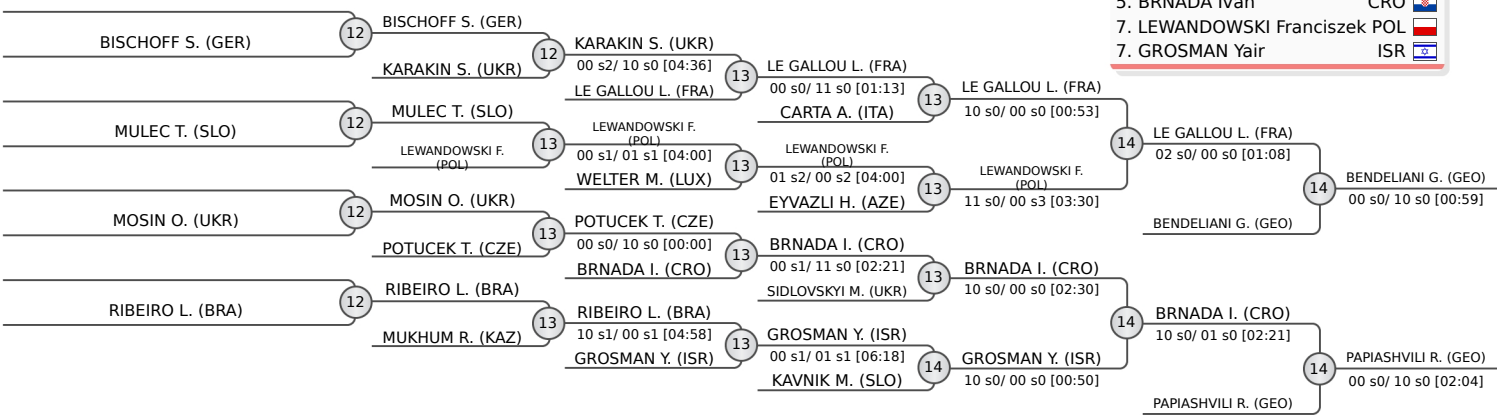



# Bielsko-Biala Cadet European Cup 2023

Poland, Bielsko-Biala, 20-21 May 2023

**-81 kg**  
Cadets (68)

POOL C

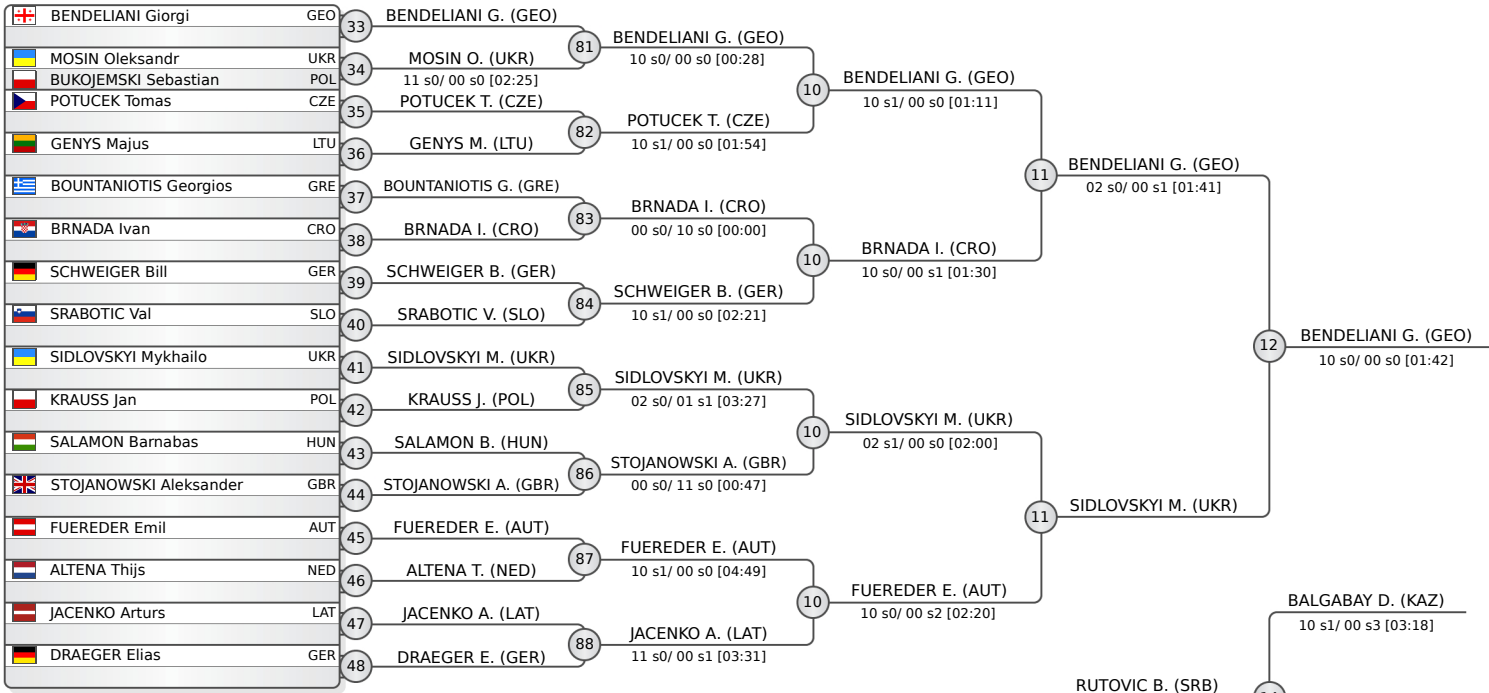

POOL D

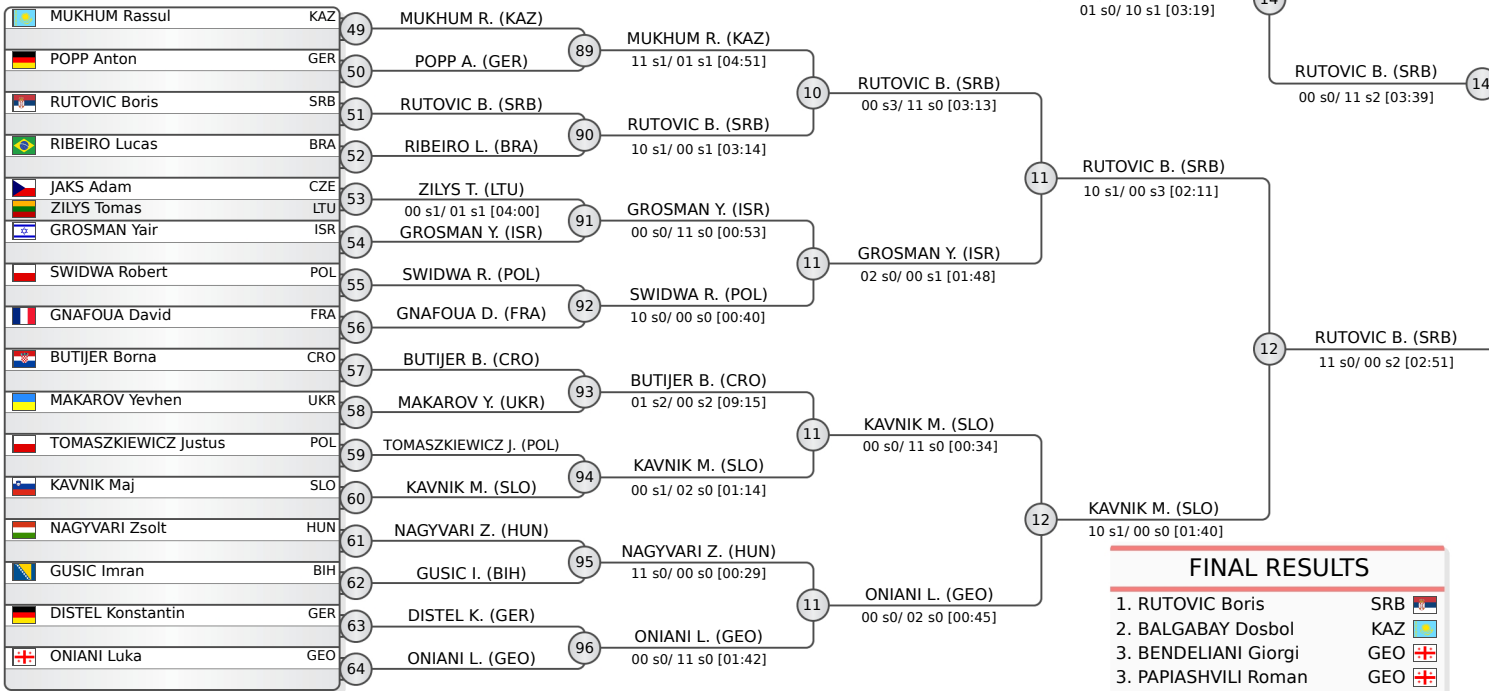

FINAL RESULTS	
1.	RUTOVIC Boris SRB
2.	BALGABAY Dosbol KAZ
3.	BENDELIANI Giorgi GEO
5.	LE GALLOU Liam FRA
5.	BRNADA Ivan CRO
7.	LEWANDOWSKI Franciszek POL
7.	GROSMAN Yair ISR

REPECHAGE

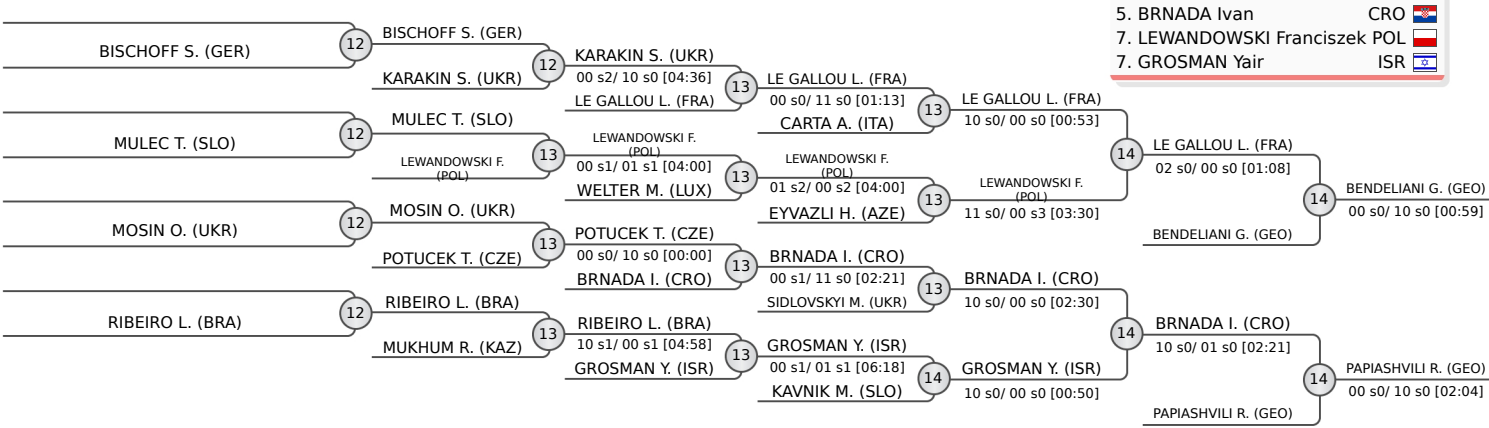



# Bielsko-Biala Cadet European Cup 2023

Poland, Bielsko-Biala, 20-21 May 2023

**-90 kg**  
Cadets (38)

**POOL A**

1	YUDANOV Nikita (UKR)	YUDANOV N. (UKR)
2	JABIYEV Emil (SWE)	JABIYEV E. (SWE)
3	KRZYNOWEK Oskar (POL)	KESIDIS Vasilis (GRE)
4	ROSSA Timur (GER)	ROSSA T. (GER)
5	KOTCHE Daniel (FRA)	KOTCHE D. (FRA)
6	FRANSENS Leonhard (NED)	OCSAK Soma Zeno (HU)
7	RAPKEVICIUS Rokas (LTU)	RAPKEVICIUS R. (LTU)
8	KOTRC Samuel (SVK)	KOTRC S. (SVK)

**POOL B**

9	BOZIC Marko (CRO)	BOZIC M. (CRO)
10	SALTONAS Aldas (LTU)	SALTONAS A. (LTU)
11	LASZCZOK Nikodem (POL)	LASZCZOK N. (POL)
12	CHAYNIKOV Dmitry (SLO)	CHAYNIKOV D. (SLO)
13	AFANASJEVS Nikita (LAT)	AFANASJEVS N. (LAT)
14	KUPRASHVILI Mikhail (GEO)	KUPRASHVILI M. (GEO)
15	BULATOVIC Pavle (MNE)	KAIS R. (FRA)
16	KAIS Rayan (FRA)	SAMOILOV Arkadii (UKR)

**POOL C**

17	ALBANO II Alexandre (BRA)	ALBANO II A. (BRA)
18	MANDIC Kazimir (CRO)	MANDIC K. (CRO)
19	RAZGORSEK Ozbej (SLO)	RAZGORSEK O. (SLO)
20	WACKO Mateusz (POL)	WACKO M. (POL)
21	SONNTAG Gaya (FRA)	SONNTAG G. (FRA)
22	PARSHYN Viacheslav (UKR)	PARSHYN V. (UKR)
23	KNEZOVIC Hrvoje (BIH)	KOSTELIDIS Angelos (GRE)
24	KOSTELIDIS Angelos (GRE)	CUPALOV Jegor (LTU)

**POOL D**

25	DINCA Alexandru (ROU)	DINCA A. (ROU)
26	GROMOV Daniils (LAT)	GROMOV D. (LAT)
27	SVATEK Jozef (SVK)	CHAMERSKI D. (POL)
28	CHAMERSKI Daniel (POL)	NEDERBRAGT Bram (NED)
29	NEDERBRAGT Bram (NED)	ZHUMANBEKOV Berikbol (KAZ)
30	ZHUMANBEKOV Berikbol (KAZ)	SHAMIL Tuncay (AZE)
31	SHAMIL Tuncay (AZE)	DRUHOV Ivan (UKR)
32	DRUHOV Ivan (UKR)	NWAHA NGOM Avi Kelian (FRA)
		HOFFER Norbert (HUN)

**REPECHAGE**

61	JABIYEV E. (SWE)	JABIYEV E. (SWE)
62	BULATOVIC P. (MNE)	ROSSA T. (GER)
63	SAMOILOV A. (UKR)	SAMOILOV A. (UKR)
64	MANDIC K. (CRO)	AFANASJEVS N. (LAT)
		WACKO M. (POL)
		GROMOV D. (LAT)
		NEDERBRAGT B. (NED)

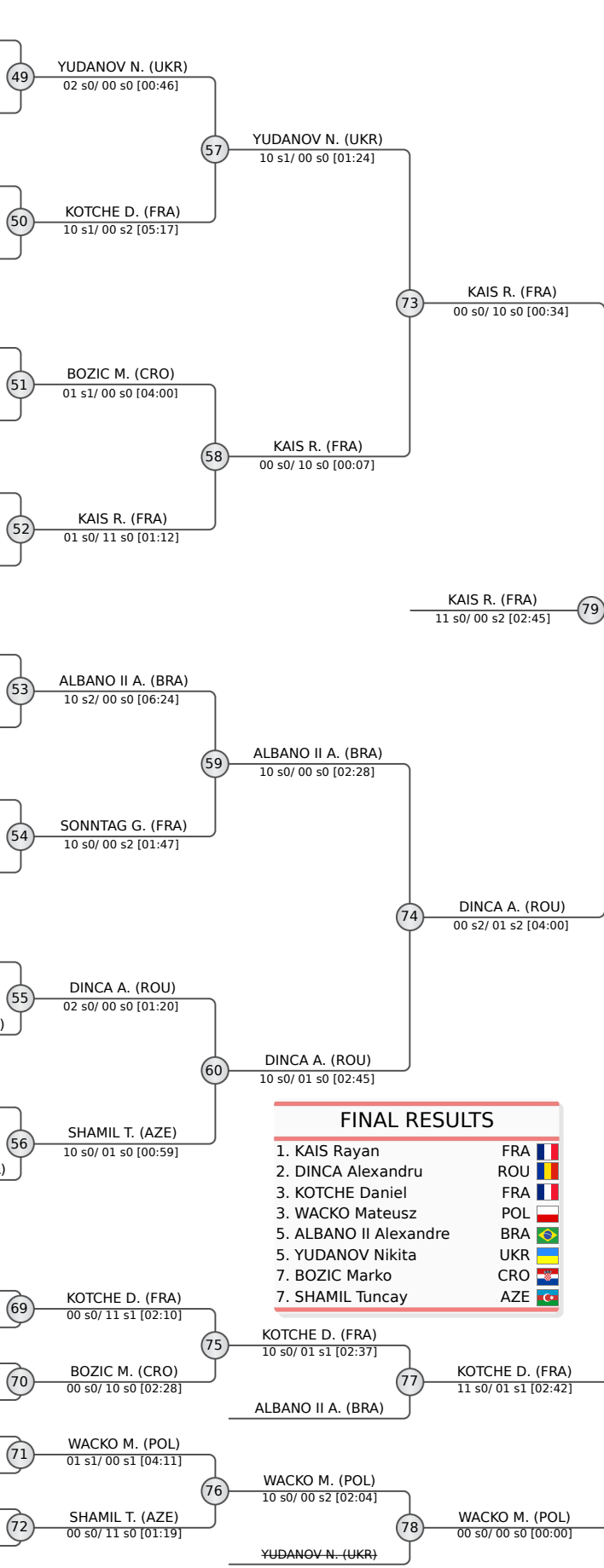

FINAL RESULTS		
1.	KAIS Rayan	FRA
2.	DINCA Alexandru	ROU
3.	KOTCHE Daniel	FRA
3.	WACKO Mateusz	POL
5.	ALBANO II Alexandre	BRA
7.	BOZIC Marko	CRO
7.	SHAMIL Tuncay	AZE



# Bielsko-Biala Cadet European Cup 2023

Poland, Bielsko-Biala, 20-21 May 2023

**+ 90 kg**  
Cadets (29)

**POOL A**

	NAZYMKHANOV Alikhan	KAZ
	REIS Gustavo	BRA
	SAMADLI Rasul	AZE
	ALPANOV Sherkhan	KAZ
	TULSKYKH Mykyta	UKR
	PAULAUSKAS Lukas	LTU
	SCHARNER Oliver	AUT

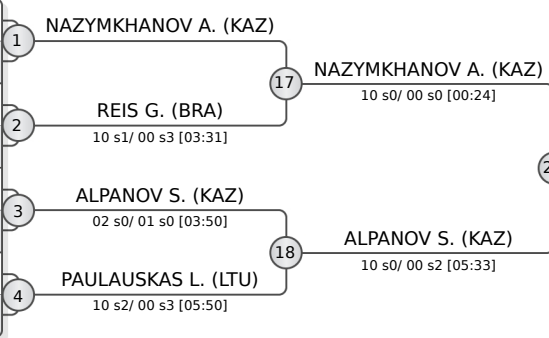

**POOL B**

	ZAAKISHVILI Nikoloz	GEO
	DUQUE Leonardo	BRA
	HROMYKO Nikita	UKR
	DA COSTA Jean Pascal Bi Goly	FRA
	BENIAIDZE Luka	GEO
	WILHELM Christian	GER
	SZEKERES Abel	HUN
	STREMAUSKAS Mykolas	LTU

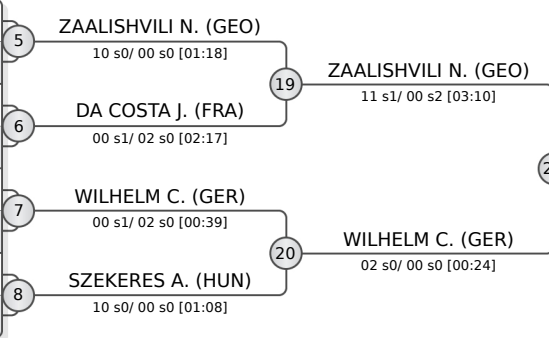

**POOL C**

	AKIANA MONGO Matheo	FRA
	ROSZAK Jakub	POL
	SEDLAK Martin	CZE
	KOVINIC Stefan	MNE
	OLIVEIRA Luis Antonio	BRA
	OMELCHENKO Yaroslav	UKR
	YERZHANULY Shynggys	KAZ

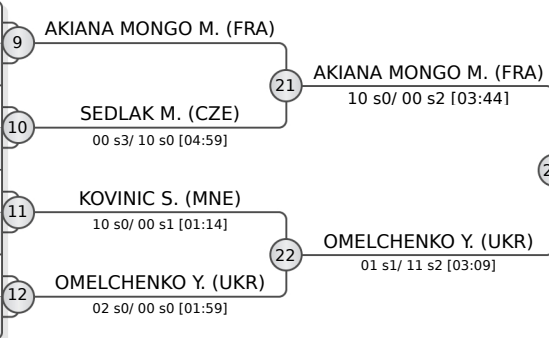

**POOL D**

	SIEWE DJIEKAM Kris Oliver	FRA
	TAURA Patrikas	LTU
	ALIYEV Eldar	AZE
	BOROJEVIC Mateja	SRB
	TOTH Miron	HUN
	FESENKO Oleh	UKR
	IVANKOVIC Luka	CRO

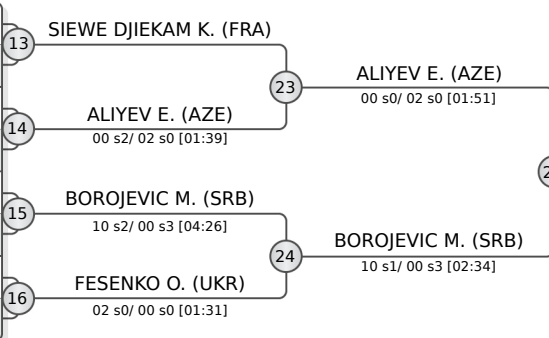

FINAL RESULTS		
1.	ZAAKISHVILI Nikoloz	GEO
2.	AKIANA MONGO Matheo	FRA
3.	ALIYEV Eldar	AZE
3.	OMELCHENKO Yaroslav	UKR
5.	NAZYMKHANOV Alikhan	KAZ
7.	WILHELM Christian	GER
7.	SIEWE DJIEKAM Kris Oliver	FRA

**REPECHAGE**

TULSKYKH M. (UKR)	29 TULSKYKH M. (UKR)	33 NAZYMKHANOV A. (KAZ)
PAULAUSKAS L. (LTU)	10 s0/ 00 s0 [00:58]	00 s3/ 10 s1 [02:45]
DUQUE L. (BRA)	30 DA COSTA J. (FRA)	39 NAZYMKHANOV A. (KAZ)
DA COSTA J. (FRA)	00 s2/ 10 s0 [01:02]	01 s2/ 00 s2 [04:00]
SEDLAK M. (CZE)	31 SEDLAK M. (CZE)	34 WILHELM C. (GER)
TAURA P. (LTU)	OMELCHENKO Y. (UKR)	00 s1/ 02 s0 [02:58]
SIEWE DJIEKAM K. (FRA)	32 SIEWE DJIEKAM K. (FRA)	40 OMELCHENKO Y. (UKR)
BOROJEVIC M. (SRB)	00 s1/ 10 s0 [01:06]	10 s1/ 00 s0 [02:12]
	36 BOROJEVIC M. (SRB)	42 OMELCHENKO Y. (UKR)
	10 s1/ 00 s3 [03:23]	02 s2/ 00 s1 [04:00]

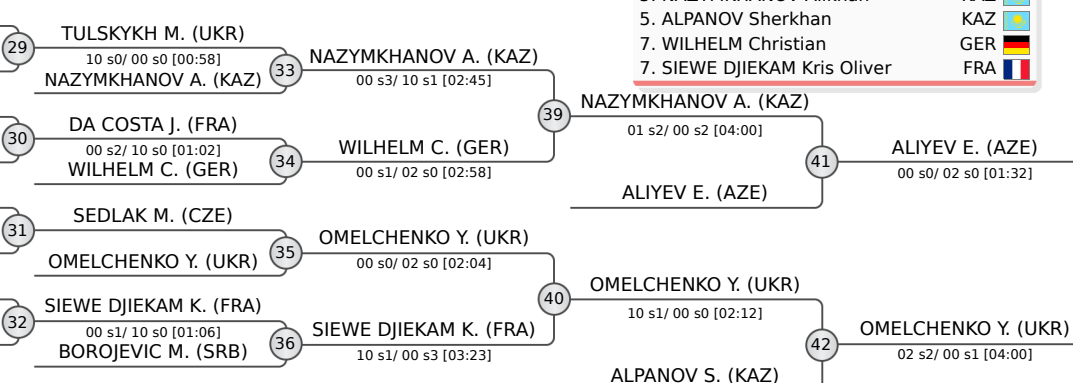





# Bielsko-Biala Cadet European Cup 2023

Poland, Bielsko-Biala, 20-21 May 2023

## -40 kg

Cadets (14)

### POOL A

	AUER Nina	AUT
	WALENDZIK Sandra	POL
	VRCINAC Milana	SRB

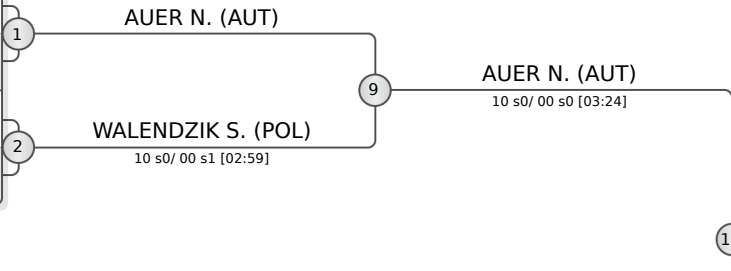

### POOL B

	VEILLARD Melody	SUI
	ONOPRIICHUK Anhelina	UKR
	CIAVURRO Rachele	ITA
	JAKOBCZYK Maria	POL

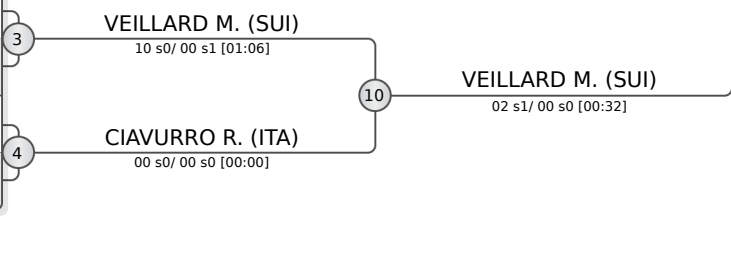

### POOL C

	AUREL Mathilde	FRA
	HERSENT Emma	FRA
	WARNERS Megan	NED

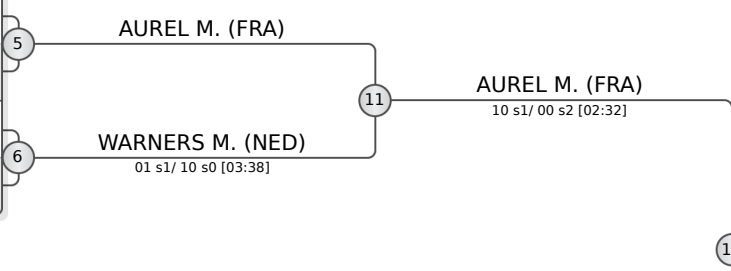

### POOL D

	MAMISHOVA Nigar	AZE
	FEUS Anemarie	SLO
	LARIA Li-Or	ISR
	SKUBEL Nicola	POL

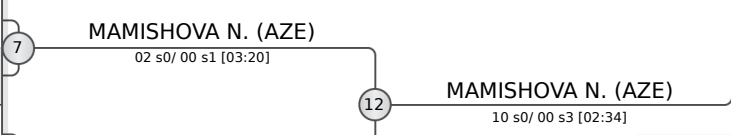

### REPECHAGE

13 WALENDZIK S. (POL)	14 CIAVURRO R. (ITA)	15 WARNERS M. (NED)	16 SKUBEL N. (POL)
ONOPRIICHUK A. (UKR)	FEUS A. (SLO)	SKUBEL N. (POL)	

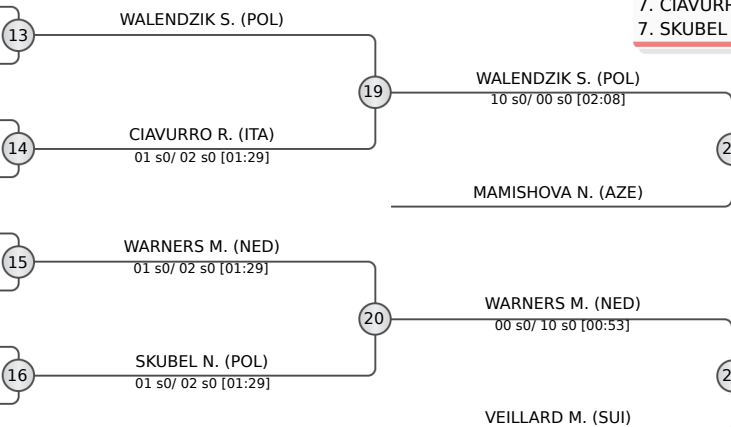

FINAL RESULTS		
1. AUER Nina	AUT	
2. AUREL Mathilde	FRA	
3. WALENDZIK Sandra	POL	
3. VEILLARD Melody	SUI	
5. MAMISHOVA Nigar	AZE	
5. WARNERS Megan	NED	
7. CIAVURRO Rachele	ITA	
7. SKUBEL Nicola	POL	



# Bielsko-Biala Cadet European Cup 2023

Poland, Bielsko-Biala, 20-21 May 2023

**-44 kg**  
Cadets (23)

**POOL A**

	KLEIN Ronja	GER
	RIBEIRO Clarice	BRA
	POTOK Nina	POL
	LOPEZ Alice	FRA
	MINASYAN Tatevik	AUT
	CORSI Margot	ITA

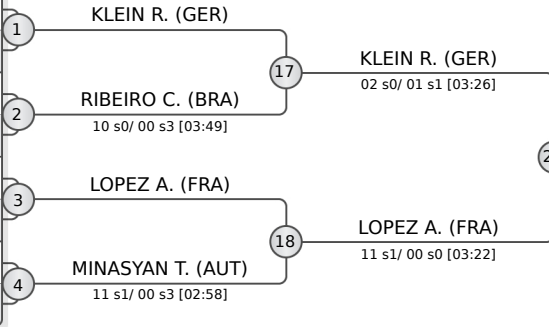

**POOL B**

	ALIKHANOVA Tamila	KAZ
	LIMA Imane	FRA
	HERTA Gabriela	MDA
	KISS Viktoria	HUN
	KOVACHEVA Preslava	BUL

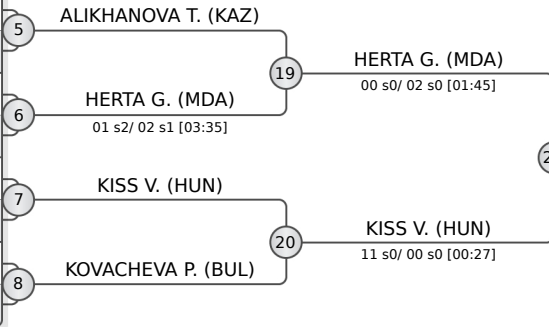

**POOL C**

	GABAY Yuval	ISR
	PROLIC Natalija	SRB
	POTOK Natasza	POL
	YOLCHUZADA Aytaj	AZE
	FINAZZER Flavia	ITA
	TUCAJ Martina	CRO

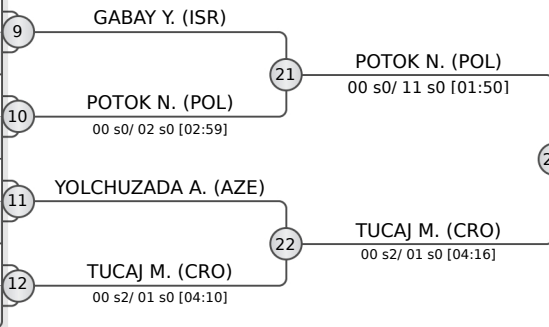

**POOL D**

	LAHRIFI Lalla-Dounia	FRA
	MORUZZI Rachele	ITA
	OLTEAN Veronica	ROU
	PECQUEUX Maia	FRA
	MENDES Sarah	BRA
	ANTOINE Lena	BEL

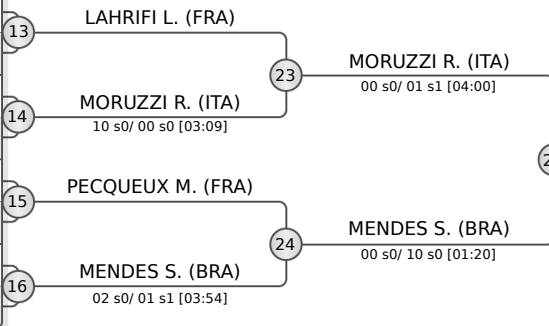

**REPECHAGE**

29	MINASYAN T. (AUT)	MINASYAN T. (AUT)
30	KOVACHEVA P. (BUL)	KOVACHEVA P. (BUL)
31	GABAY Y. (ISR)	GABAY Y. (ISR)
32	PECQUEUX M. (FRA)	PECQUEUX M. (FRA)
33	KLEIN R. (GER)	KLEIN R. (GER)
34	HERTA G. (MDA)	HERTA G. (MDA)
35	GABAY Y. (ISR)	GABAY Y. (ISR)
36	ANTOINE L. (BEL)	ANTOINE L. (BEL)

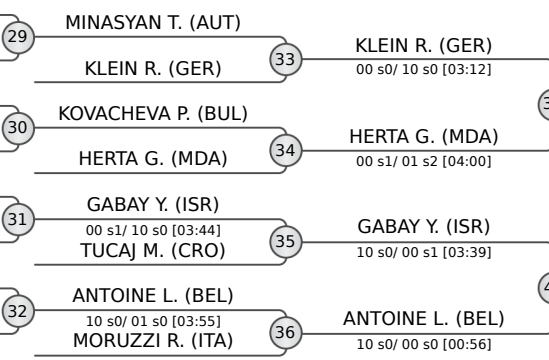

43 MENDES S. (BRA) [04:00]

38 MENDES S. (BRA) [04:38]

FINAL RESULTS	
1.	MENDES Sarah (BRA)
2.	LOPEZ Alice (FRA)
3.	KLEIN Ronja (GER)
3.	KISS Viktoria (HUN)
5.	POTOK Natasza (POL)
5.	ANTOINE Lena (BEL)
7.	HERTA Gabriela (MDA)
7.	GABAY Yuval (ISR)



# Bielsko-Biala Cadet European Cup 2023

Poland, Bielsko-Biala, 20-21 May 2023

## -48 kg

Cadets (43)

POOL A

1	LE CAM Mel (FRA)
2	HADAR Noa (ISR)
3	MOMOT Neonila (UKR)
4	ARGEMI Maria Antonia (BRA)
5	MISZEWSKA Michalina (POL)
6	EINIKAITE Vytaute (LTU)
7	ZGLICZYNSKA Alicja (POL)
8	DELANEY Ruby (GBR)
9	NETTESHEIM Charlotte (GER)
10	GEORGIEVA Margarita (BUL)
11	MARQUES Nicole (BRA)

1	LE CAM M. (FRA)
2	HADAR N. (ISR)
3	ARGEMI M. (BRA)
4	MISZEWSKA M. (POL)
5	EINIKAITE V. (LTU)
6	ZGLICZYNSKA A. (POL)
7	NETTESHEIM C. (GER)
8	MARQUES N. (BRA)

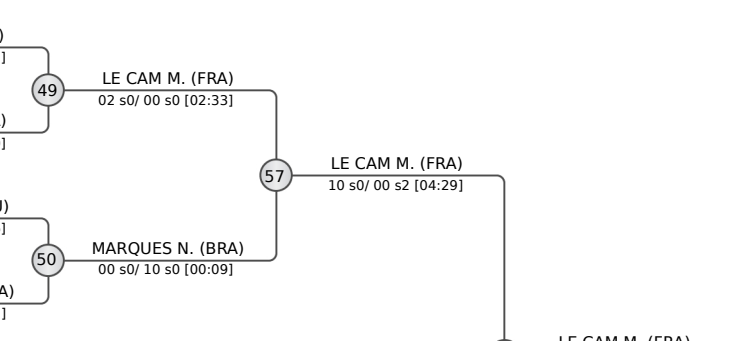

POOL B

9	KORCAKOVA Marketa (CZE)
10	PAUCHENKO Viktoriia (UKR)
11	CAVALCANTE Isadora (BRA)
12	STORM Sophia Grace (GER)
13	STOFBERG Lara (NED)
14	KHEGAY Kira (KAZ)
15	CZERWINSKA-KOWAR Roksana (POL)
16	CARRACA Celina (SUI)
17	KURKOV Isabell (GER)
18	VARDAROVA Kalina (BUL)
19	MANDA Lorena (ROU)

9	KORCAKOVA M. (CZE)
10	PAUCHENKO V. (UKR)
11	STORM S. (GER)
12	STOFBERG L. (NED)
13	KHEGAY K. (KAZ)
14	CARRACA C. (SUI)
15	KURKOV I. (GER)
16	MANDA L. (ROU)

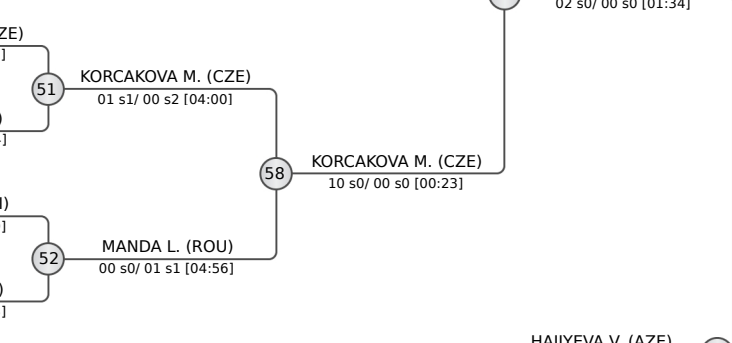

POOL C

17	HAIJIYEVA Vusala (AZE)
18	MONNEY Lya (SUI)
19	CARNEIRO Nycolly (BRA)
20	FROSZTEGA Iga (POL)
21	ANTOVA Zoya (BUL)
22	TWAROWSKA Barbara (POL)
23	BERNON Lison (FRA)
24	BUSAUSKAITE Migle (LTU)
25	REISZ Frida (GER)
26	MIROSHNICHENKO Marharyta (UKR)
27	LETONIA Dora (CRO)

17	HAIJIYEVA V. (AZE)
18	MONNEY L. (SUI)
19	CARNEIRO N. (BRA)
20	ANTOVA Z. (BUL)
21	TWAROWSKA B. (POL)
22	BERNON L. (FRA)
23	MIROSHNICHENKO M. (UKR)
24	LETONIA D. (CRO)

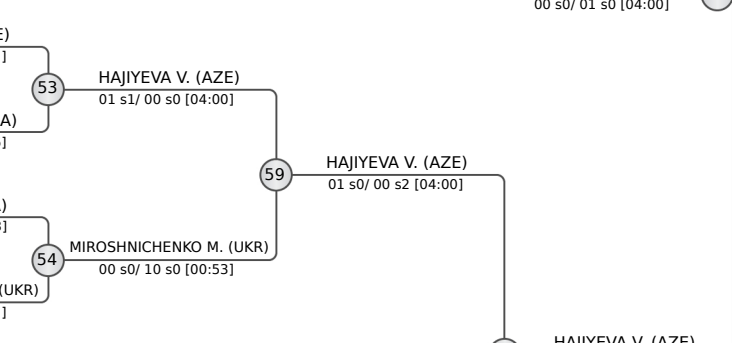

POOL D

25	NOUFAL Noor (NED)
26	SZABO Reka (HUN)
27	SHCHUR Sofia (UKR)
28	KUZMICKA Julia (POL)
29	SILVA Cecilia (BRA)
30	BECKER Libi (ISR)
31	NICOTRA Siria Angel (ITA)
32	ABDUALI Tasnim (KAZ)
33	ERTEN Klara (GER)
34	VONDRAKOVA Lada (CZE)

25	NOUFAL N. (NED)
26	SHCHUR S. (UKR)
27	KUZMICKA J. (POL)
28	SILVA C. (BRA)
29	BECKER L. (ISR)
30	NICOTRA S. (ITA)
31	ERTEN K. (GER)
32	VONDRAKOVA L. (CZE)

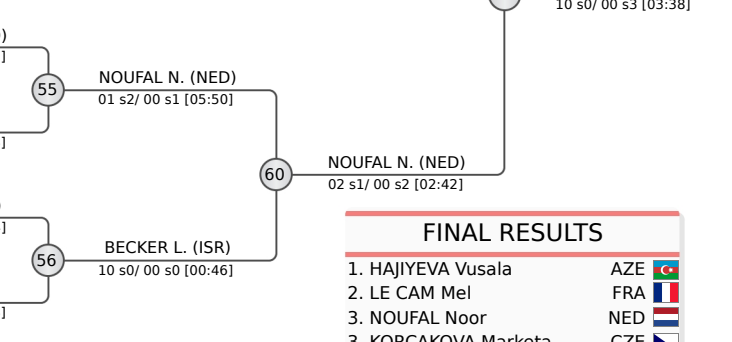

FINAL RESULTS		
1.	HAIJIYEVA Vusala	AZE
2.	LE CAM Mel	FRA
3.	NOUFAL Noor	NED
3.	KORCAKOVA Marketa	CZE
5.	HADAR Noa	ISR
5.	CARNEIRO Nycolly	BRA
7.	MANDA Lorena	ROU
7.	SHCHUR Sofia	UKR

REPECHAGE

61	HADAR N. (ISR)
62	PAUCHENKO V. (UKR)
63	MONNEY L. (SUI)
64	SHCHUR S. (UKR)

61	HADAR N. (ISR)
62	PAUCHENKO V. (UKR)
63	MONNEY L. (SUI)
64	SHCHUR S. (UKR)

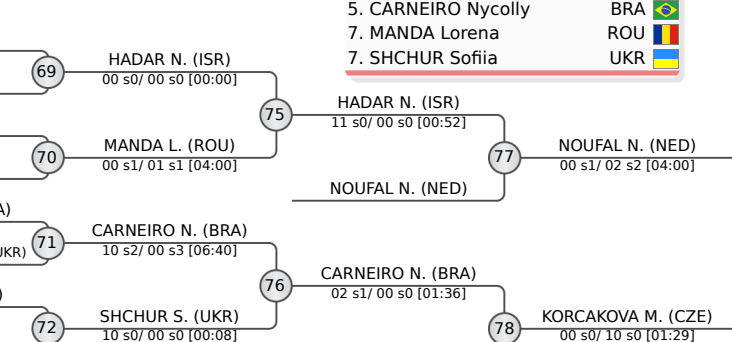



# Bielsko-Biala Cadet European Cup 2023

Poland, Bielsko-Biala, 20-21 May 2023

## -52 kg

Cadets (47)

POOL A

1	JESIONEK Maria (POL)	1	JESIONEK M. (POL)
2	GACIC Mina (SRB)	2	GACIC M. (SRB)
3	HOLLER Marlene (GER)	3	ROCHA M. (BRA)
4	BOZSO Zita (HUN)	4	POPESCU D. (ROU)
5	ROCHA Mariana (BRA)	5	MAROZAIT R. (LTU)
6	POPESCU Daliana (ROU)	6	TOSZE M. (GER)
7	MAROZAIT R. (LTU)	7	GEORGIEVA D. (BUL)
8	TOSZE M. (GER)	8	MARQUES A. (FRA)
	MIS Gabriela (POL)		MARQUES A. (FRA)
	DOVZHENKO Kateryna (UKR)		
	GEORGIEVA Denitsa (BUL)		
	MARQUES Alicia (FRA)		

POOL B

9	GADASHOVA Khadzizha (AZE)	9	GADASHOVA K. (AZE)
10	BARFOOT-SAUNT Olivia (GBR)	10	BUWALDA A. (NED)
11	BUWALDA Amara (NED)	11	URBAN P. (GER)
12	SEVERYN Anastasiia (UKR)	12	NOWAK K. (POL)
13	URBAN Pia (GER)	13	SOCOLSKY A. (ISR)
14	NOWAK Klaudia (POL)	14	MESICEK N. (SLO)
15	SOCOLSKY Adi (ISR)	15	LEVCHENKO A. (UKR)
16	RIEDER Emma (AUT)	16	MOS M. (POL)
	MESICEK Neza (SLO)		
	LEVCHENKO Anastasiia (UKR)		
	ERIC Lana (BIH)		
	MOS Marika (POL)		

POOL C

17	POULANGE Alyssia (FRA)	17	POULANGE A. (FRA)
18	MECKLENBURG Tabea Nika (GER)	18	MECKLENBURG T. (GER)
19	YEMELIANOVA Yelyzaveta (UKR)	19	ROBINSON L. (GBR)
20	ROBINSON Lucy (GBR)	20	DUDA J. (POL)
21	DUDA Julia (POL)	21	RUSTIGE E. (NED)
22	RUSTIGE Elise (NED)	22	CIALINI B. (ITA)
23	MAJ Veronika (HUN)	23	KOCHAUF M. (AUT)
24	CIALINI Beatrice (ITA)	24	KAISER K. (GER)
	KOCHAUF Maya (AUT)		
	KOZUL Maria (BIH)		
	KAISER Katharina (GER)		

POOL D

25	VEG Luca (HUN)	25	VEG L. (HUN)
26	NOWAK Jessica (POL)	26	ZARRA C. (GRE)
27	ZARRA Christina (GRE)	27	VODIANN M. (UKR)
28	POMANA Silvia (ROU)	28	VERDIYEVA A. (AZE)
29	VODIANN Melaniia (UKR)	29	BIBE L. (ISR)
30	VERDIYEVA Aytan (AZE)	30	MARTENS L. (BEL)
31	BIBE Lian (ISR)	31	SCHINWALD Marlene (AUT)
32	MARTENS Line (BEL)	32	GUETH N. (GER)
	SCHINWALD Marlene (AUT)		
	GUETH Nina (GER)		
	ZIEMBLA Lena (POL)		
	SAVIC Bojana (SRB)		

REPECHAGE

61	MIS G. (POL)	61	MIS G. (POL)
62	MARQUES A. (FRA)	62	BUWALDA A. (NED)
63	JESIONEK M. (POL)	63	MECKLENBURG T. (GER)
64	ROBINSON L. (GBR)	64	ZARRA C. (GRE)
65	MARQUES A. (FRA)	65	VERDIYEVA A. (AZE)
66	URBAN P. (GER)	66	SAVIC B. (SRB)
67	LEVCHENKO A. (UKR)	67	VERDIYEVA A. (AZE)
68	MECKLENBURG T. (GER)	68	SAVIC B. (SRB)
69	MARQUES A. (FRA)	69	VERDIYEVA A. (AZE)
70	LEVCHENKO A. (UKR)	70	SAVIC B. (SRB)
71	MECKLENBURG T. (GER)	71	VERDIYEVA A. (AZE)
72	MECKLENBURG T. (GER)	72	SAVIC B. (SRB)
73	MARQUES A. (FRA)	73	VERDIYEVA A. (AZE)
74	LEVCHENKO A. (UKR)	74	SAVIC B. (SRB)
75	MARQUES A. (FRA)	75	VERDIYEVA A. (AZE)
76	MECKLENBURG T. (GER)	76	SAVIC B. (SRB)
77	MARQUES A. (FRA)	77	VERDIYEVA A. (AZE)
78	TOSZE M. (GER)	78	SAVIC B. (SRB)

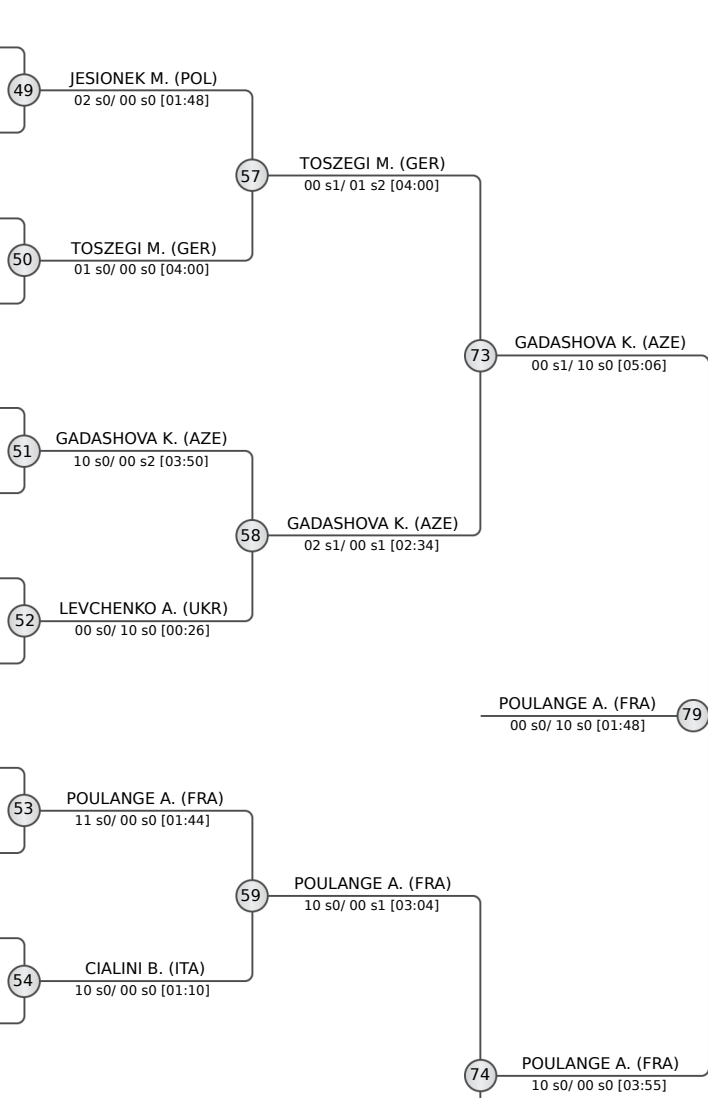

FINAL RESULTS		
1.	POULANGE Alyssia	FRA
2.	GADASHOVA Khadzizha	AZE
3.	MARQUES Alicia	FRA
3.	TOSZE M. (GER)	GER
5.	VEG Luca	HUN
5.	MECKLENBURG Tabea Nika	GER
7.	LEVCHENKO Anastasiia	UKR
7.	VERDIYEVA Aytan	AZE





# Bielsko-Biala Cadet European Cup 2023

Poland, Bielsko-Biala, 20-21 May 2023

# -57 kg

Cadets (50)

## POOL A

	ZAKROISKY Hili	ISR
	BAZSANYI Dorka	HUN
	SEMOUD Luna	GER
	TOMBOLINI Alisia	ITA
	CESLAUSKAITE Deimante	LTU
	ZOZULINSKA Kalina	POL
	KLEIJMEER Celine	NED
	BASTOS Eduarda	BRA
	ZHENGIS Nuray	KAZ
	KERGALVE Viktorija	LAT
	DZIOB Wiktoria	POL
	VLKOVA Eliska	CZE
	CHERNUKHA Veronika	UKR

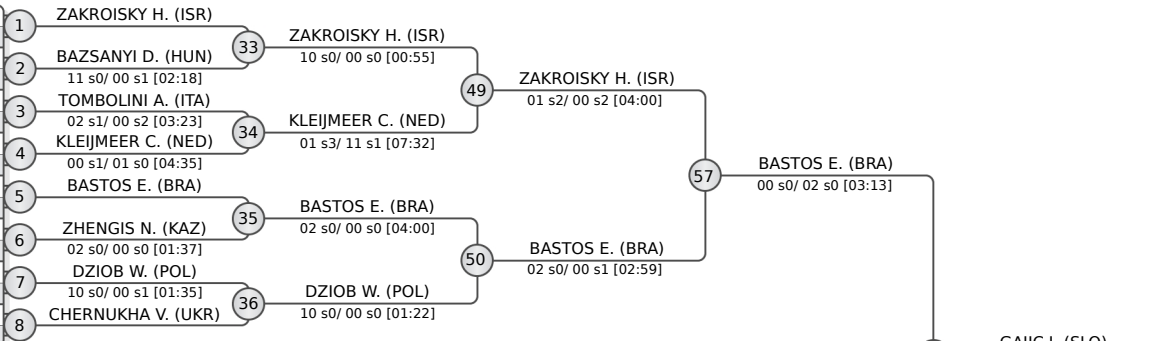

## POOL B

	NICOLAS Ielena	FRA
	BOZHKO Yelyzaveta	UKR
	POZNANOVIC Ekaterina	SRB
	BOELCSKEI Hanna	GER
	BETZ Lisa	AUT
	BOELSMA Mila	NED
	GAJIC Jevgenija	SLO
	HERMANOVA Karolina	CZE
	FRADE Victoria	BRA
	KWAPIS Kinga	POL
	ZUEND Annika	SUI
	KEELER Flox	NED

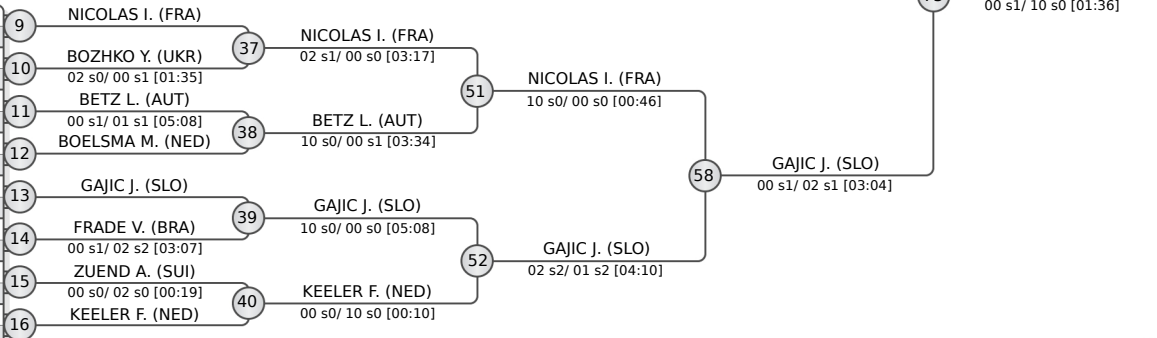

## POOL C

	BIELAWSKA Emilia	POL
	DES COGNETS-JULIE Lou	FRA
	HOO Fedra	HUN
	MARTELLACCI Alice	ITA
	WILDSCHUT Lieke	NED
	BALBEK Diana	UKR
	BULJONE Alisa	LAT
	SKERYTE Ugne	LTU
	SKALJIC Sejla	CRO
	SINNEMA Fleur	NED
	MOLDRZYK Wiktoria	POL
	WOLSFELD Sara-Tamar	GER
	VEINHANDL OBAID Haya	SLO

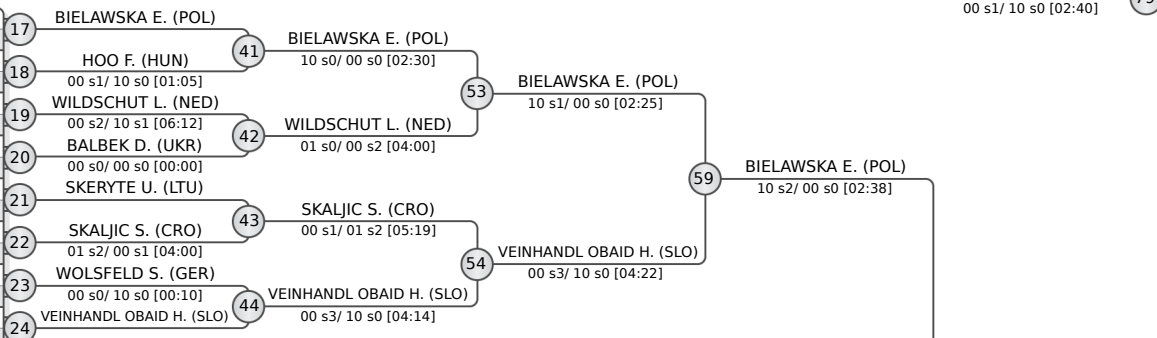

## POOL D

	SANTIAGO-SANTANA Odalis	GER
	AQUINO Pietra	BRA
	SCERBOVA Amalie	CZE
	KOLAKOWSKA Zuzanna	POL
	VAN OUDGAARDEN Fleur	NED
	PAVLOVIC Nevena	SRB
	GERETZKI Vanessa	GER
	VOVK Sofiia	UKR
	ADAMACHI Maya	ROU
	CHOMAT Meloe	FRA
	DRABIK Zsofia	HUN
	RASIMENOKA Marija	LAT

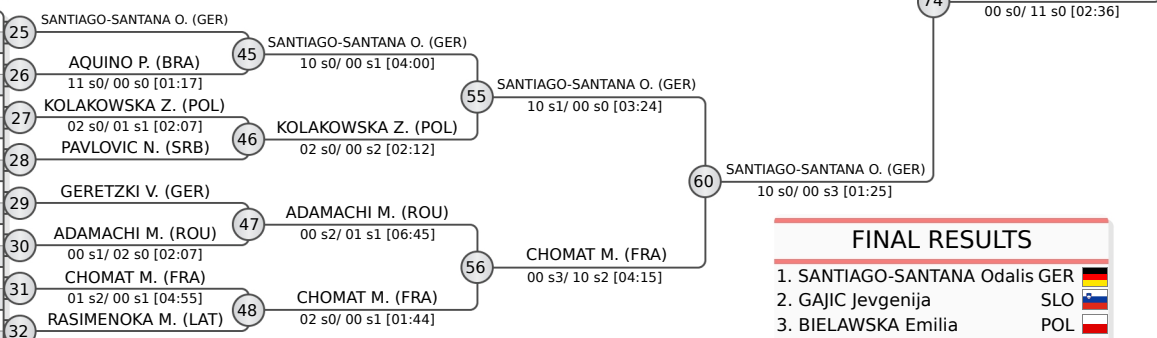

FINAL RESULTS	
1.	SANTIAGO-SANTANA Odalis GER
2.	GAJIC Jevgenija SLO
3.	BIELAWSKA Emilia POL
3.	BASTOS Eduarda BRA
5.	ZAKROISKY Hili ISR
5.	HOO Fedra HUN
7.	NICOLAS Ielena FRA
7.	CHOMAT Meloe FRA

## REPECHAGE

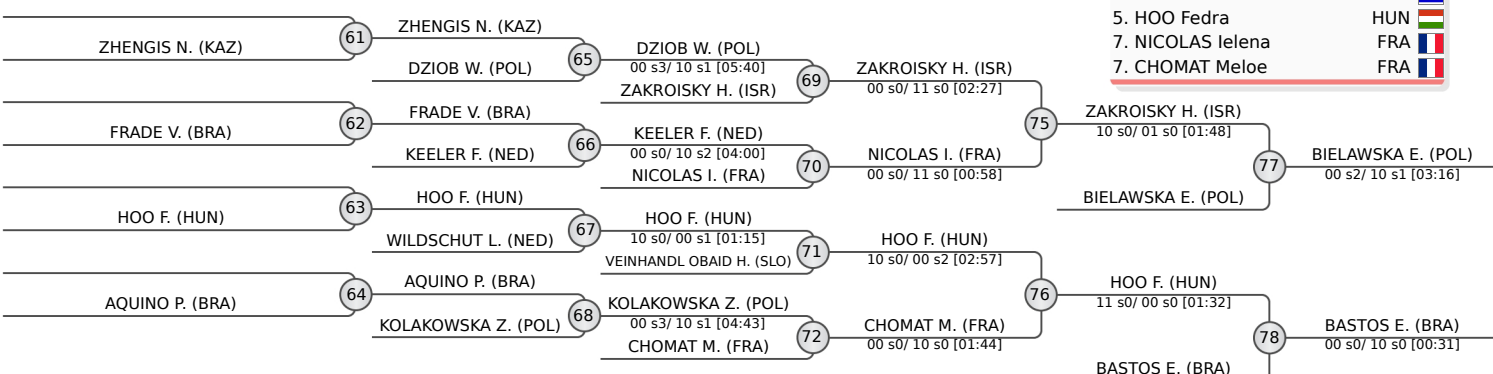



# Bielsko-Biala Cadet European Cup 2023

Poland, Bielsko-Biala, 20-21 May 2023

## -63 kg

Cadets (56)

### POOL A

ISR	BOARON Lihi	ISR
CZE	LEXOVA Lucie	CZE
SUI	PROBST Eileen	SUI
POL	SCHENK Magdalena	POL
SRB	VUKICEVIC Dunja	SRB
AZE	TOHOLIYEVA Kamilla	AZE
GER	WALLENHORST Lea-Marie	GER
FRA	BENGHEZAL Emma	FRA
GER	GARLAND Marley	GER
BRA	DEMARCO Ana Clara	BRA
BIH	DZIDIC Korina	BIH
POL	PTASINSKA Amelia	POL
UKR	TKACHOVA Anna	UKR
SLO	HORVAT Veronika	SLO

1	BOARON L. (ISR)	33	BOARON L. (ISR)		
2	PROBST E. (SUI)	00 s3/ 11 s0 [03:39]	10 s0/ 00 s0 [00:24]		
3	VUKICEVIC D. (SRB)	00 s3/ 10 s0 [02:51]	49	BOARON L. (ISR)	
4	TOHOLIYEVA K. (AZE)	00 s0/ 02 s0 [01:24]	34	TOHOLIYEVA K. (AZE)	
5	BENGHEZAL E. (FRA)	10 s0/ 00 s0 [01:27]	57	BOARON L. (ISR)	
6	GARLAND M. (GER)	01 s2/ 00 s2 [05:56]	35	BENGHEZAL E. (FRA)	
7	PTASINSKA A. (POL)	00 s0/ 02 s0 [02:50]	50	BENGHEZAL E. (FRA)	
8	HORVAT V. (SLO)	10 s0/ 00 s0 [00:28]	36	PTASINSKA A. (POL)	
				73	BOARON L. (ISR)
					10 s0/ 00 s0 [00:10]

### POOL B

KAZ	ZHAISSANGBAY Zhibek	KAZ
GER	LISTL Emma	GER
HUN	BOTZHEIM Bodza	HUN
POL	BAGNIEWSKA Amelia	POL
ROU	BOB Isabel	ROU
BRA	MARCON Carolina	BRA
SVK	DRDAKOVA Martina	SVK
POL	GLUBIAK Magda	POL
SRB	VUKADINOVIC Djurdja	SRB
AUT	ROTTENHOFER Helena	AUT
CZE	VRANOVA Sara	CZE
NED	VAN DER MAAS Kim	NED
UKR	VOZNIUK Liudmyla	UKR
FRA	CHIPAN Jaelynn	FRA

9	ZHAISSANGBAY Z. (KAZ)	37	ZHAISSANGBAY Z. (KAZ)		
10	BOTZHEIM B. (HUN)	00 s2/ 01 s2 [04:00]	51	ZHAISSANGBAY Z. (KAZ)	
11	BOB I. (ROU)	00 s3/ 10 s0 [01:37]	38	MARCON C. (BRA)	
12	MARCON C. (BRA)	00 s3/ 10 s2 [08:02]	58	ZHAISSANGBAY Z. (KAZ)	
13	GLUBIAK M. (POL)	10 s0/ 00 s3 [02:26]	39	GLUBIAK M. (POL)	
14	VUKADINOVIC D. (SRB)	11 s0/ 00 s1 [00:47]	52	GLUBIAK M. (POL)	
15	VAN DER MAAS K. (NED)	00 s0/ 02 s0 [02:09]	40	CHIPAN J. (FRA)	
16	CHIPAN J. (FRA)	00 s1/ 10 s1 [06:44]	40	CHIPAN J. (FRA)	
				79	BOARON L. (ISR)
					10 s0/ 00 s0 [00:27]

### POOL C

CRO	MARKULIN Nika	CRO
ROU	SUCIU Anamaria	ROU
SUI	HALBHEER Svenja	SUI
GER	WINTER Leya	GER
SLO	SIKOSEK Ajda	SLO
UKR	KARPUKHOVA Anhelina	UKR
POL	HANNA Zaitseva	POL
LTU	KUCHAR Varvara	LTU
UKR	OPANASENKO Kristina	UKR
POL	TATAJ Julia	POL
ITA	BASILI Nicole	ITA
HUN	KRUPL Georgina	HUN
BRA	MENDONCA Julia	BRA
GER	BAUER Ann-Jolie	GER

17	MARKULIN N. (CRO)	41	HALBHEER S. (SUI)		
18	HALBHEER S. (SUI)	00 s0/ 10 s1 [01:20]	53	HALBHEER S. (SUI)	
19	SIKOSEK A. (SLO)	01 s0/ 10 s0 [01:58]	42	HANNA Z. (POL)	
20	HANNA Z. (POL)	00 s0/ 10 s1 [03:38]	59	HALBHEER S. (SUI)	
21	KUCHAR V. (LTU)	10 s0/ 00 s0 [01:09]	54	KRUPL G. (HUN)	
22	OPANASENKO K. (UKR)	10 s0/ 00 s0 [00:51]	43	KUCHAR V. (LTU)	
23	KRUPL G. (HUN)	00 s0/ 10 s0 [02:28]	44	KRUPL G. (HUN)	
24	BAUER A. (GER)	01 s1/ 00 s2 [04:54]	44	KRUPL G. (HUN)	
				74	GALLUDEC E. (FRA)
					00 s0/ 10 s0 [01:20]

### POOL D

AUT	BAYR Leonie	AUT
HUN	SARKOZI Zsuzsa	HUN
BRA	CAMARA Sophia	BRA
FRA	GALLUDEC Emmy	FRA
POL	PIETRZAK Gabriela	POL
SRB	NISAVIC Jelena	SRB
GER	KONRAD Sveyarike	GER
CZE	SIMUNKOVA Adela	CZE
GER	STEINEBRUNNER Salome	GER
LAT	PONOMARJOVA Sofija	LAT
SLO	PARTLIC Julija	SLO
POL	WITKOWSKA Wiktoria	POL
UKR	TERLETSKA Olha	UKR
NED	VAN DEN HIL Danielle	NED

25	BAYR L. (AUT)	45	CAMARA S. (BRA)		
26	CAMARA S. (BRA)	00 s1/ 02 s0 [03:28]	55	GALLUDEC E. (FRA)	
27	GALLUDEC E. (FRA)	00 s0/ 02 s1 [01:53]	46	GALLUDEC E. (FRA)	
28	NISAVIC J. (SRB)	02 s0/ 01 s0 [01:19]	56	SIMUNKOVA A. (CZE)	
29	SIMUNKOVA A. (CZE)	11 s0/ 00 s0 [00:46]	47	SIMUNKOVA A. (CZE)	
30	PONOMARJOVA S. (LAT)	00 s0/ 01 s1 [04:17]	48	WITKOWSKA W. (POL)	
31	WITKOWSKA W. (POL)	00 s0/ 02 s0 [00:25]	56	SIMUNKOVA A. (CZE)	
32	VAN DEN HIL D. (NED)	00 s3/ 10 s2 [07:41]	48	WITKOWSKA W. (POL)	
				75	GLUBIAK M. (POL)
					00 s1/ 10 s0 [08:18]

### REPECHAGE

61	PROBST E. (SUI)	65	PROBST E. (SUI)
62	BOTZHEIM B. (HUN)	66	MARCON C. (BRA)
63	MARKULIN N. (CRO)	67	MARKULIN N. (CRO)
64	NISAVIC J. (SRB)	68	CAMARA S. (BRA)

65	TOHOLIYEVA K. (AZE)	69	BENGHEZAL E. (FRA)
66	MARCON C. (BRA)	70	GLUBIAK M. (POL)
67	HANNA Z. (POL)	71	MARKULIN N. (CRO)
68	CAMARA S. (BRA)	72	CAMARA S. (BRA)

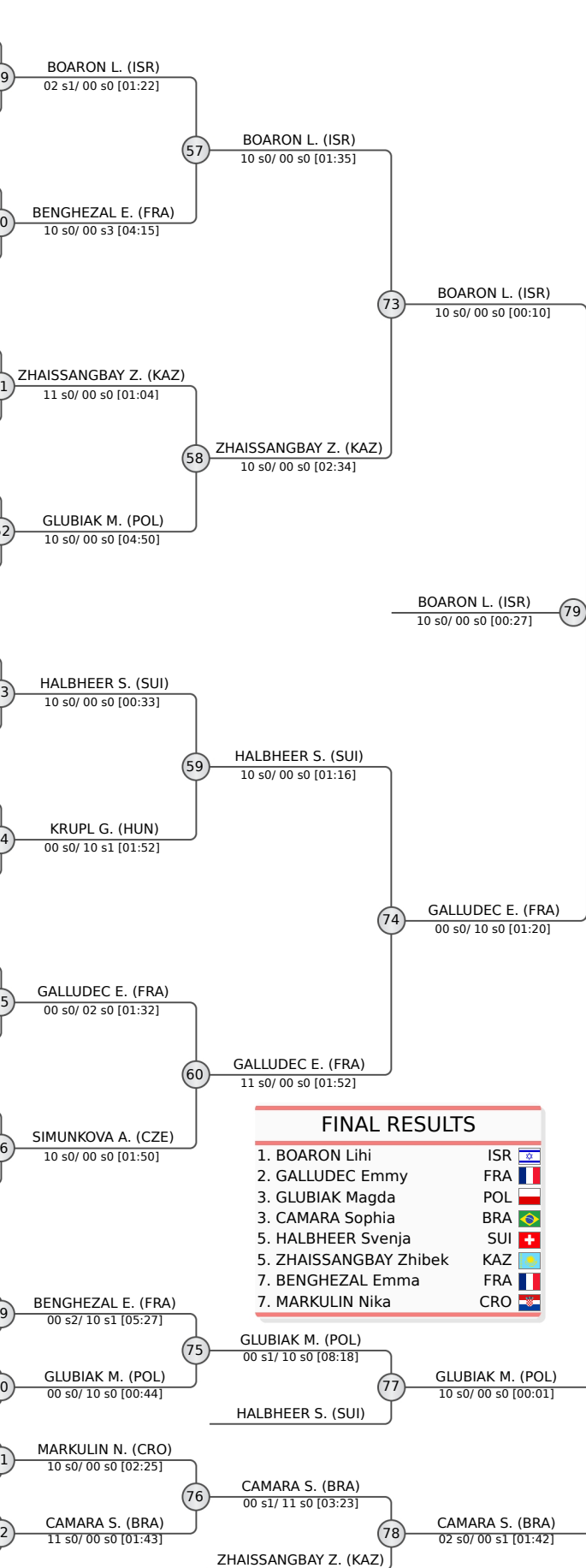

FINAL RESULTS		
1.	BOARON Lihi	ISR
2.	GALLUDEC Emmy	FRA
3.	GLUBIAK Magda	POL
3.	CAMARA Sophia	BRA
5.	HALBHEER Svenja	SUI
5.	ZHAISSANGBAY Zhibek	KAZ
7.	BENGHEZAL Emma	FRA
7.	MARKULIN Nika	CRO



# Bielsko-Biala Cadet European Cup 2023

Poland, Bielsko-Biala, 20-21 May 2023

## -70 kg

Cadets (39)

POOL A

	WERNERT Jael	AUT	1
	IBATOLLA Anissa	KAZ	2
	ELKABAZ Hadar	ISR	3
	PIKOSZ Nicole	POL	4
	NEMCOVA Barbora	CZE	4
	MILJEVIC Vedrana	CRO	5
	ZAVRSNIK Masa	SLO	6
	TITOVETS Kira	UKR	6
	HAPPE Lilli	GER	7
	SZYMANIAK Julia	POL	8

1	WERNERT J. (AUT)	IBATOLLA A. (KAZ)	33
2	IBATOLLA A. (KAZ)	IBATOLLA A. (KAZ)	00 s0/ 02 s0 [00:35]
3	ELKABAZ H. (ISR)	NEMCOVA B. (CZE)	34
4	NEMCOVA B. (CZE)	NEMCOVA B. (CZE)	00 s1/ 10 s0 [00:23]
5	MILJEVIC V. (CRO)	MILJEVIC V. (CRO)	35
6	TITOVETS K. (UKR)	MILJEVIC V. (CRO)	10 s0/ 01 s2 [03:22]
7	HAPPE L. (GER)	HAPPE L. (GER)	36
8	SZYMANIAK J. (POL)	HAPPE L. (GER)	02 s0/ 01 s1 [02:27]

49	IBATOLLA A. (KAZ)	HAPPE L. (GER)	57
49	IBATOLLA A. (KAZ)	HAPPE L. (GER)	02 s0/ 00 s0 [01:12]
50	HAPPE L. (GER)	HAPPE L. (GER)	50
50	HAPPE L. (GER)	HAPPE L. (GER)	00 s0/ 10 s0 [00:15]
73	HOJDAROVA S. (CZE)	HAPPE L. (GER)	57
73	HOJDAROVA S. (CZE)	HAPPE L. (GER)	00 s3/ 11 s0 [03:40]

POOL B

	JAAFAR Nadie	BUL	9
	RULLIER Lucie	FRA	10
	VAN LIJF Xanne	NED	11
	VEN Panna	HUN	12
	STALIONYTE Paulina	LTU	12
	HOJDAROVA Stepanka	CZE	13
	VINNYCHUK Karyna	UKR	14
	KIKOLSKA Maja	POL	15
	LUEDEMANN Jessie	GER	15
	BIZQUIAZO-CRISTOREAN Francesca	ROU	16

9	JAAFAR N. (BUL)	JAAFAR N. (BUL)	37
9	JAAFAR N. (BUL)	JAAFAR N. (BUL)	01 s1/ 00 s0 [04:00]
10	RULLIER L. (FRA)	VAN LIJF X. (NED)	51
10	RULLIER L. (FRA)	VAN LIJF X. (NED)	00 s3/ 10 s1 [03:26]
11	VAN LIJF X. (NED)	VAN LIJF X. (NED)	38
11	VAN LIJF X. (NED)	VAN LIJF X. (NED)	10 s0/ 00 s2 [01:17]
12	STALIONYTE P. (LTU)	HOJDAROVA S. (CZE)	39
12	STALIONYTE P. (LTU)	HOJDAROVA S. (CZE)	10 s0/ 00 s1 [03:23]
13	HOJDAROVA S. (CZE)	HOJDAROVA S. (CZE)	52
13	HOJDAROVA S. (CZE)	HOJDAROVA S. (CZE)	10 s1/ 00 s2 [02:29]
14	VINNYCHUK K. (UKR)	LUEDEMANN J. (GER)	40
14	VINNYCHUK K. (UKR)	LUEDEMANN J. (GER)	00 s0/ 10 s0 [02:15]
15	LUEDEMANN J. (GER)	LUEDEMANN J. (GER)	40
15	LUEDEMANN J. (GER)	LUEDEMANN J. (GER)	02 s0/ 00 s0 [00:40]
16	BIZQUIAZO-CRISTOREAN F. (ROU)	HOJDAROVA S. (CZE)	52
16	BIZQUIAZO-CRISTOREAN F. (ROU)	HOJDAROVA S. (CZE)	10 s1/ 00 s2 [02:29]

51	VAN LIJF X. (NED)	HOJDAROVA S. (CZE)	58
51	VAN LIJF X. (NED)	HOJDAROVA S. (CZE)	00 s3/ 10 s1 [03:26]
52	HOJDAROVA S. (CZE)	HOJDAROVA S. (CZE)	52
52	HOJDAROVA S. (CZE)	HOJDAROVA S. (CZE)	10 s1/ 00 s2 [02:29]
73	HOJDAROVA S. (CZE)	HOJDAROVA S. (CZE)	58
73	HOJDAROVA S. (CZE)	HOJDAROVA S. (CZE)	00 s0/ 01 s2 [04:00]
79	OLIINYK-KORNIKO A. (UKR)	HOJDAROVA S. (CZE)	58
79	OLIINYK-KORNIKO A. (UKR)	HOJDAROVA S. (CZE)	00 s0/ 11 s0 [01:10]

POOL C

	SAGITZHAN Saulemay	KAZ	17
	NEBOUT Anais	FRA	18
	WALDHOER Jessica	AUT	19
	SHERBAKOV Eva	ISR	19
	THIELE Alica	GER	20
	OLIINYK-KORNIKO Anna	UKR	21
	TOMANOVA Nikola	CZE	22
	SZATKOWSKA Natalia	POL	22
	BAUR Coco-Mia	GER	23
	BOUVIER Marielle	BEL	24

17	SAGITZHAN S. (KAZ)	SAGITZHAN S. (KAZ)	41
17	SAGITZHAN S. (KAZ)	SAGITZHAN S. (KAZ)	10 s0/ 00 s0 [01:01]
18	NEBOUT A. (FRA)	THIELE A. (GER)	42
18	NEBOUT A. (FRA)	THIELE A. (GER)	02 s0/ 00 s0 [00:44]
19	SHERBAKOV E. (ISR)	THIELE A. (GER)	42
19	SHERBAKOV E. (ISR)	THIELE A. (GER)	00 s0/ 10 s0 [02:29]
20	THIELE A. (GER)	OLIINYK-KORNIKO A. (UKR)	43
20	THIELE A. (GER)	OLIINYK-KORNIKO A. (UKR)	11 s0/ 00 s0 [01:41]
21	OLIINYK-KORNIKO A.	OLIINYK-KORNIKO A. (UKR)	43
21	OLIINYK-KORNIKO A.	OLIINYK-KORNIKO A. (UKR)	11 s0/ 00 s0 [01:41]
22	TOMANOVA N. (CZE)	OLIINYK-KORNIKO A. (UKR)	54
22	TOMANOVA N. (CZE)	OLIINYK-KORNIKO A. (UKR)	10 s0/ 00 s0 [00:18]
23	BAUR C. (GER)	OLIINYK-KORNIKO A. (UKR)	54
23	BAUR C. (GER)	OLIINYK-KORNIKO A. (UKR)	10 s0/ 00 s0 [00:18]
24	BOUVIER M. (BEL)	BAUR C. (GER)	44
24	BOUVIER M. (BEL)	BAUR C. (GER)	01 s0/ 00 s1 [04:00]

53	THIELE A. (GER)	OLIINYK-KORNIKO A. (UKR)	59
53	THIELE A. (GER)	OLIINYK-KORNIKO A. (UKR)	00 s0/ 10 s0 [01:16]
54	OLIINYK-KORNIKO A. (UKR)	OLIINYK-KORNIKO A. (UKR)	54
54	OLIINYK-KORNIKO A. (UKR)	OLIINYK-KORNIKO A. (UKR)	10 s0/ 00 s0 [00:18]
59	OLIINYK-KORNIKO A. (UKR)	OLIINYK-KORNIKO A. (UKR)	59
59	OLIINYK-KORNIKO A. (UKR)	OLIINYK-KORNIKO A. (UKR)	00 s0/ 10 s0 [00:16]
74	OLIINYK-KORNIKO A. (UKR)	OLIINYK-KORNIKO A. (UKR)	59
74	OLIINYK-KORNIKO A. (UKR)	OLIINYK-KORNIKO A. (UKR)	11 s0/ 00 s2 [01:49]

POOL D

	MUTEBA Nina	FRA	25
	KLINGER Johanna Elisabeth	BIH	26
	KOLNY Oktawia	POL	26
	NEUMANN Malin	GER	27
	MOSTERMAN Ellemiek	NED	28
	NAVICKAITE Marta	LTU	29
	MICAS Adina	ROU	30
	SLACEK Nika	CRO	31
	NAHORIANSKA Iryna	UKR	32

25	MUTEBA N. (FRA)	MUTEBA N. (FRA)	45
25	MUTEBA N. (FRA)	MUTEBA N. (FRA)	02 s0/ 00 s0 [02:15]
26	KOLNY O. (POL)	MUTEBA N. (FRA)	45
26	KOLNY O. (POL)	MUTEBA N. (FRA)	00 s0/ 10 s0 [01:11]
27	NEUMANN M. (GER)	NEUMANN M. (GER)	46
27	NEUMANN M. (GER)	NEUMANN M. (GER)	01 s1/ 00 s0 [04:20]
28	MOSTERMAN E. (NED)	NAVICKAITE M. (LTU)	47
28	MOSTERMAN E. (NED)	NAVICKAITE M. (LTU)	02 s0/ 00 s0 [02:30]
29	NAVICKAITE M. (LTU)	NAVICKAITE M. (LTU)	47
29	NAVICKAITE M. (LTU)	NAVICKAITE M. (LTU)	02 s0/ 00 s0 [02:30]
30	MICAS A. (ROU)	NAVICKAITE M. (LTU)	47
30	MICAS A. (ROU)	NAVICKAITE M. (LTU)	02 s0/ 00 s0 [02:30]
31	SLACEK N. (CRO)	NAVICKAITE M. (LTU)	47
31	SLACEK N. (CRO)	NAVICKAITE M. (LTU)	10 s1/ 00 s2 [01:55]
32	NAHORIANSKA I. (UKR)	NAVICKAITE M. (LTU)	47
32	NAHORIANSKA I. (UKR)	NAVICKAITE M. (LTU)	10 s1/ 00 s2 [01:55]

55	MUTEBA N. (FRA)	NAVICKAITE M. (LTU)	60
55	MUTEBA N. (FRA)	NAVICKAITE M. (LTU)	10 s0/ 00 s0 [00:46]
56	NAVICKAITE M. (LTU)	NAVICKAITE M. (LTU)	56
56	NAVICKAITE M. (LTU)	NAVICKAITE M. (LTU)	10 s1/ 00 s2 [01:55]
60	NAVICKAITE M. (LTU)	NAVICKAITE M. (LTU)	60
60	NAVICKAITE M. (LTU)	NAVICKAITE M. (LTU)	00 s0/ 10 s0 [01:37]

FINAL RESULTS		
1.	OLIINYK-KORNIKO Anna	UKR
2.	HOJDAROVA Stepanka	CZE
3.	MILJEVIC Vedrana	CRO
3.	MUTEBA Nina	FRA
5.	NAVICKAITE Marta	LTU
5.	HAPPE Lilli	GER
7.	VINNYCHUK Karyna	UKR
7.	BAUR Coco-Mia	GER

REPECHAGE

61	SZYMANIAK J. (POL)	MILJEVIC V. (CRO)	65
61	SZYMANIAK J. (POL)	MILJEVIC V. (CRO)	00 s0/ 10 s1 [00:41]
62	VINNYCHUK K. (UKR)	IBATOLLA A. (KAZ)	69
62	VINNYCHUK K. (UKR)	IBATOLLA A. (KAZ)	02 s0/ 00 s0 [00:29]
63	TOMANOVA N. (CZE)	VINNYCHUK K. (UKR)	70
63	TOMANOVA N. (CZE)	VINNYCHUK K. (UKR)	02 s1/ 00 s1 [01:35]
64	MICAS A. (ROU)	VAN LIJF X. (NED)	71
64	MICAS A. (ROU)	VAN LIJF X. (NED)	11 s0/ 00 s0 [00:55]
65	MILJEVIC V. (CRO)	NAVICKAITE M. (LTU)	75
65	MILJEVIC V. (CRO)	NAVICKAITE M. (LTU)	02 s2/ 00 s1 [03:23]
66	VINNYCHUK K. (UKR)	NAVICKAITE M. (LTU)	75
66	VINNYCHUK K. (UKR)	NAVICKAITE M. (LTU)	02 s2/ 00 s1 [03:23]
67	BAUR C. (GER)	MUTEBA N. (FRA)	76
67	BAUR C. (GER)	MUTEBA N. (FRA)	00 s0/ 10 s0 [00:39]
68	NAHORIANSKA I. (UKR)	MUTEBA N. (FRA)	76
68	NAHORIANSKA I. (UKR)	MUTEBA N. (FRA)	00 s0/ 10 s0 [00:50]
69	MILJEVIC V. (CRO)	MUTEBA N. (FRA)	76
69	MILJEVIC V. (CRO)	MUTEBA N. (FRA)	00 s0/ 10 s0 [00:50]
70	VINNYCHUK K. (UKR)	HAPPE L. (GER)	77
70	VINNYCHUK K. (UKR)	HAPPE L. (GER)	01 s2/ 00 s1 [04:00]
71	BAUR C. (GER)	HAPPE L. (GER)	77
71	BAUR C. (GER)	HAPPE L. (GER)	10 s0/ 00 s0 [00:22]
72	MUTEBA N. (FRA)	HAPPE L. (GER)	78
72	MUTEBA N. (FRA)	HAPPE L. (GER)	11 s0/ 01 s3 [03:15]

65	MILJEVIC V. (CRO)	MILJEVIC V. (CRO)	69
65	MILJEVIC V. (CRO)	MILJEVIC V. (CRO)	00 s0/ 10 s1 [00:41]
66	VINNYCHUK K. (UKR)	VINNYCHUK K. (UKR)	70
66	VINNYCHUK K. (UKR)	VINNYCHUK K. (UKR)	02 s1/ 00 s1 [01:35]
67	BAUR C. (GER)	BAUR C. (GER)	71
67	BAUR C. (GER)	BAUR C. (GER)	00 s0/ 10 s0 [01:56]
68	NAHORIANSKA I. (UKR)	THIELE A. (GER)	71
68	NAHORIANSKA I. (UKR)	THIELE A. (GER)	10 s0/ 00 s0 [00:22]
69	MILJEVIC V. (CRO)	MUTEBA N. (FRA)	76
69	MILJEVIC V. (CRO)	MUTEBA N. (FRA)	00 s0/ 10 s0 [00:50]
70	VINNYCHUK K. (UKR)	MUTEBA N. (FRA)	76
70	VINNYCHUK K. (UKR)	MUTEBA N. (FRA)	00 s0/ 10 s0 [00:50]
71	BAUR C. (GER)	MUTEBA N. (FRA)	76
71	BAUR C. (GER)	MUTEBA N. (FRA)	00 s0/ 10 s0 [00:50]
72	MUTEBA N. (FRA)	MUTEBA N. (FRA)	76
72	MUTEBA N. (FRA)	MUTEBA N. (FRA)	00 s0/ 10 s0 [00:50]
73	HOJDAROVA S. (CZE)	HAPPE L. (GER)	77
73	HOJDAROVA S. (CZE)	HAPPE L. (GER)	01 s2/ 00 s1 [04:00]
74	OLIINYK-KORNIKO A. (UKR)	HAPPE L. (GER)	77
74	OLIINYK-KORNIKO A. (UKR)	HAPPE L. (GER)	11 s0/ 00 s2 [01:49]
75	MILJEVIC V. (CRO)	HAPPE L. (GER)	77
75	MILJEVIC V. (CRO)	HAPPE L. (GER)	02 s2/ 00 s1 [03:23]
76	MUTEBA N. (FRA)	HAPPE L. (GER)	78
76	MUTEBA N. (FRA)	HAPPE L. (GER)	00 s0/ 10 s0 [00:39]
77	MILJEVIC V. (CRO)	HAPPE L. (GER)	77
77	MILJEVIC V. (CRO)	HAPPE L. (GER)	01 s2/ 00 s1 [04:00]
78	MUTEBA N. (FRA)	HAPPE L. (GER)	78
78	MUTEBA N. (FRA)	HAPPE L. (GER)	11 s0/ 01 s3 [03:15]



# Bielsko-Biala Cadet European Cup 2023

Poland, Bielsko-Biala, 20-21 May 2023

**+ 70 kg**  
Cadets (26)

**POOL A**

	CANCAN Celia	FRA
	AHIEIEVA Anastasiia	UKR
	MUSIC Maja	SLO
	ODOR Veronika	HUN
	BOERSMA Isala	NED
	KEMELKHANKYZY Nurshat	KAZ
	PIECHNA Olga	POL

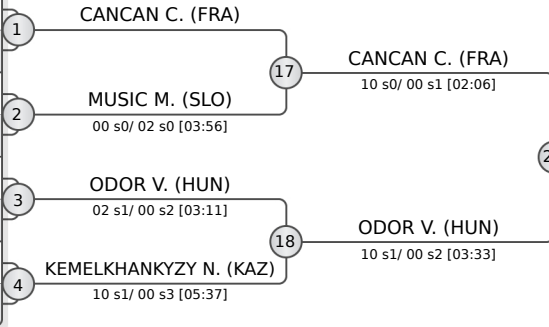

**POOL B**

	SCHRATTENHOLZER Helene	AUT
	EININGE Saule	LTU
	DOLIA Daria	UKR
	AKTAS Emma-Melis	EST
	MITAKIDOU Ilektra-Evangelia	GRE
	TROKA Julia	POL

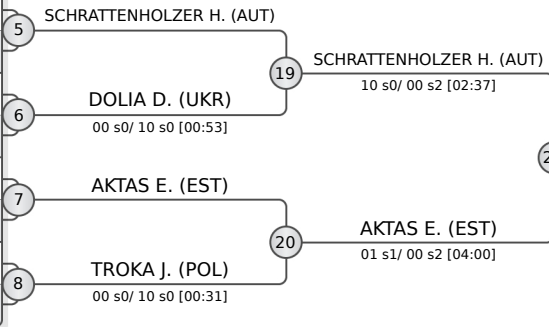

**POOL C**

	MINKADA-CAQUINEAU Leonie	FRA
	ROMANIK Oliwia	POL
	CSISZAR Csenge	HUN
	WIDLAK Nicole	POL
	SMIRNOVA Alina	UKR
	LASIC Ana	BIH
	OLIVEIRA Olivia	BRA

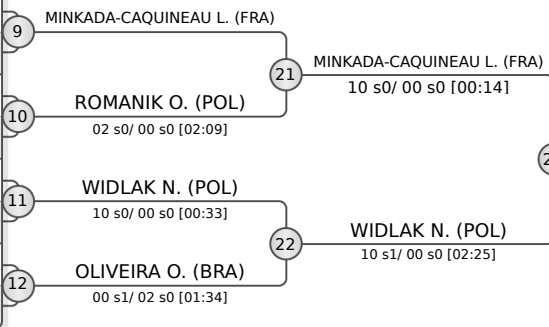

**POOL D**

	TENGELBAYEVA Guldana	KAZ
	VISA Roxana	ROU
	WOOD Nicole	GBR
	KASZPEROVA Kristyna	CZE
	EINORYTE Toma	LTU
	HUPERT Oliwia	POL

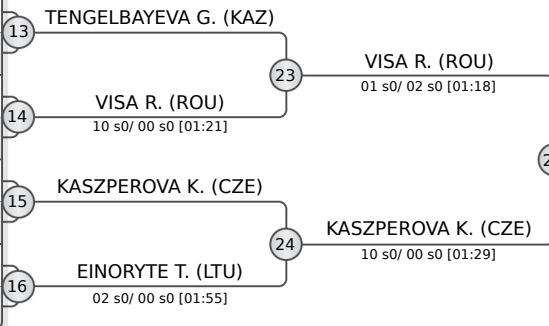

**REPECHAGE**

	MUSIC M. (SLO)	29	MUSIC M. (SLO)	33	ODOR V. (HUN)
	DOLIA D. (UKR)	30	DOLIA D. (UKR)	34	AKTAS E. (EST)
	ROMANIK O. (POL)	31	ROMANIK O. (POL)	35	VISA R. (ROU)
	EINORYTE T. (LTU)	32	EINORYTE T. (LTU)	36	VISA R. (ROU)

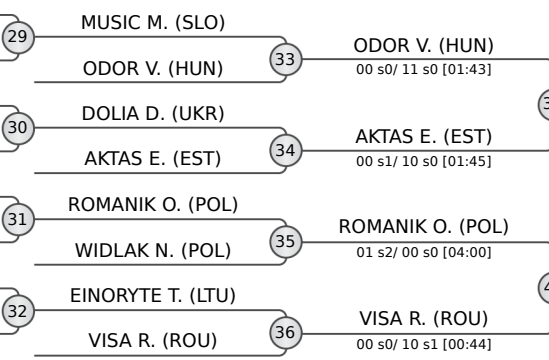

FINAL RESULTS		
1.	CANCAN Celia	FRA
2.	MINKADA-CAQUINEAU Leonie	FRA
3.	AKTAS Emma-Melis	EST
3.	VISA Roxana	ROU
5.	KASZPEROVA Kristyna	CZE
5.	SCHRATTENHOLZER Helene	AUT
7.	ODOR Veronika	HUN
7.	ROMANIK Oliwia	POL