



# Paks Junior European Cup 2023

Hungary, Paks, 8-9 Jul 2023

**-60 kg**  
Juniors (42)

**POOL A**

	RAY Kelvin	FRA
	RUBINSTEIN Roy	ISR
	TOMANEK Jozef	SVK
	BARKBY Ben	GBR
	HORBAN Artem	UKR
	PIECHOTA Stanislaw	POL
	KEZIC Dusan	SRB
	BIGAMBAYEV Tabyldy	KAZ
	GAANAN Raphael	CAN
	NAVON Maayan	ISR
	RAZDEVSEK Matic	SLO

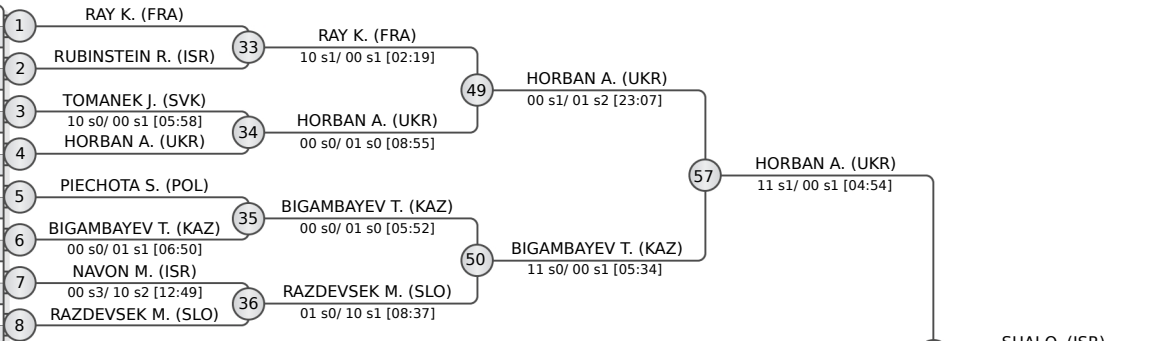

**POOL B**

	DIJOL Zacharie	FRA
	EL MEKKAOUI Soulaïmane	MAR
	KREMERMAN Daniil	CAN
	SHAI Ori Gal	ISR
	KLEPININ Oleksandr	UKR
	ELION GAMBOU Roland Antonin	FRA
	VLAD Andrei	ROU
	VEG Milan	HUN
	YANG Joshua	USA
	MCCLIFTY Liam	AUS

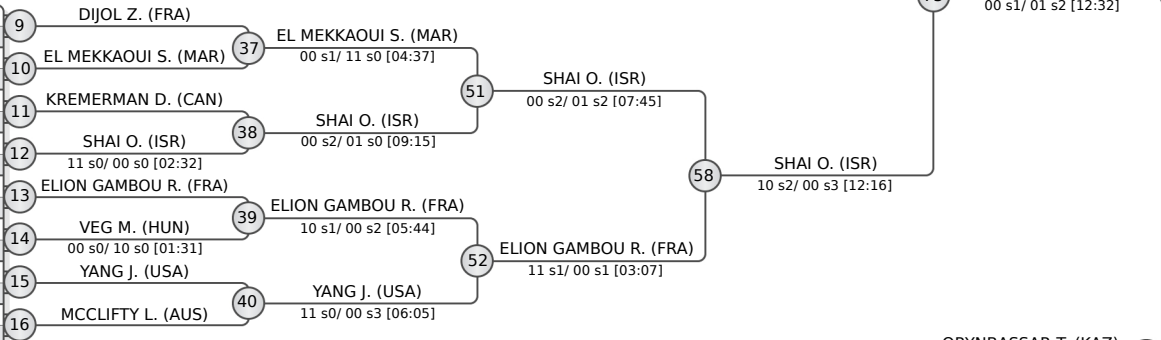

**POOL C**

	VELAZCO Christopher	USA
	HUTCHEON Angus	AUS
	FLUM Fabio	SUI
	EATON Samuel	GBR
	ALHAZOV Tal	ISR
	FARKAS Bence	HUN
	MAMADOV Karimdzhon	UKR
	YELEUSSIZOV Ulan	KAZ
	GAL Ori	ISR
	SAMEC Jaka	SLO

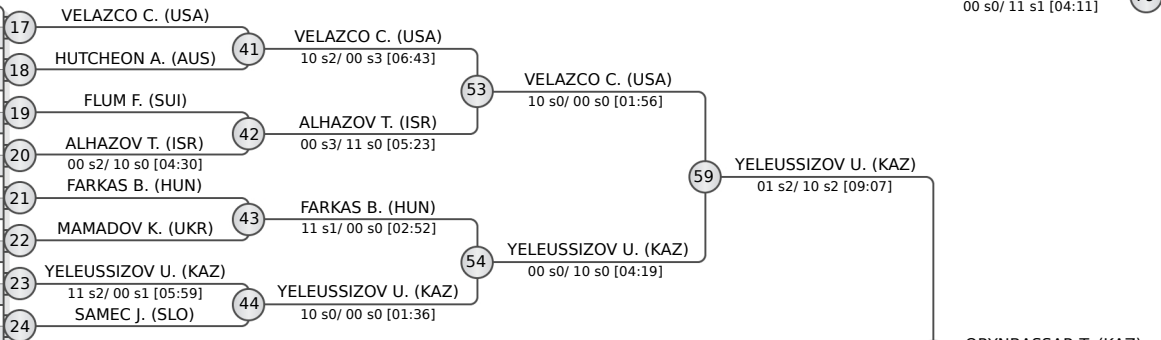

**POOL D**

	FRYER Lewis	GBR
	VILLAVICENCIO Galo	ARG
	LARKIN Danylo	UKR
	DESSUREAULT Victor	CAN
	COHEN Ido	ISR
	GUSTIUC Cristian	MDA
	JEREMIC Matija	SRB
	VORONA Daniil	UKR
	REDA Jad	AUS
	ORYNBASSAR Talgat	KAZ
	STEIN PADOA Daniel	ISR

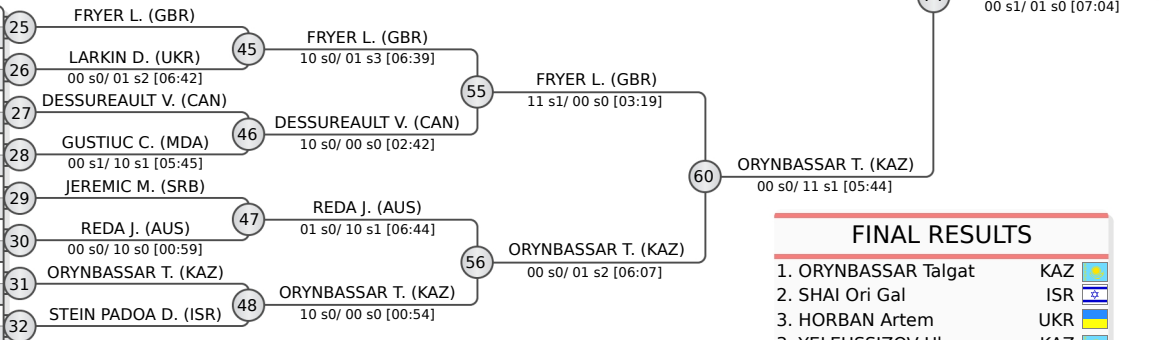

**REPECHAGE**

	TOMANEK J. (SVK)	61
	KLEPININ O. (UKR)	62
	SAMEC J. (SLO)	63
	STEIN PADOA D. (ISR)	64
	RAY K. (FRA)	65
	KREMERMAN D. (CAN)	66
	FARKAS B. (HUN)	67
	REDA J. (AUS)	68
	RAY K. (FRA)	69
	BIGAMBAYEV T. (KAZ)	70
	EL MEKKAOUI S. (MAR)	71
	FARKAS B. (HUN)	72
	VELAZCO C. (USA)	73
	FRYER L. (GBR)	74
	RAY K. (FRA)	75
	ELION GAMBOU R. (FRA)	76
	FARKAS B. (HUN)	77
	HORBAN A. (UKR)	78

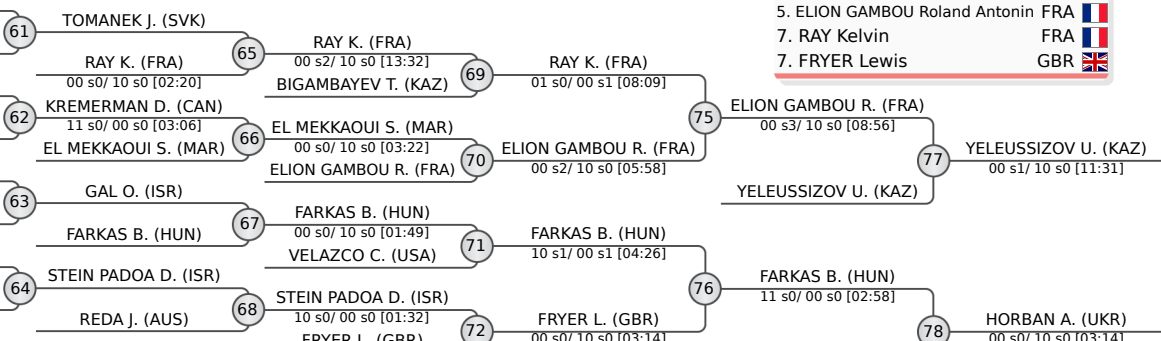

FINAL RESULTS		
1.	ORYNBASSAR Talgat	KAZ
2.	SHAI Ori Gal	ISR
3.	HORBAN Artem	UKR
3.	YELEUSSIZOV Ulan	KAZ
5.	FARKAS Bence	HUN
5.	ELION GAMBOU Roland Antonin	FRA
7.	RAY Kelvin	FRA
7.	FRYER Lewis	GBR



# Paks Junior European Cup 2023

Hungary, Paks, 8-9 Jul 2023

## -66 kg

Juniors (53)

POOL A

1	FIKS Eran	ISR
2	DE CARDAILLAC Frederic	CAN
3	HLADSKYI Stanislav	UKR
4	MAJOR Adam	HUN
5	GREENBANK Jordon	AUS
6	KING Ryan	GBR
7	DUDAS Morgan Viktor	HUN
8	LESAUVAGE Simon	FRA
9	FARKAS Zsombor	HUN
10	RAHAMIM Ofek	ISR
11	PROKOP Andreas	AUT
12	IVANOV Kyrilo	UKR
13	MURATKALI Ali	KAZ

1	FIKS E. (ISR)	33	FIKS E. (ISR)
2	DE CARDAILLAC F. (CAN)	34	GREENBANK J. (AUS)
3	GREENBANK J. (AUS)	35	RAHAMIM O. (ISR)
4	DUDAS M. (HUN)	36	IVANOV K. (UKR)
5	LESAUVAGE S. (FRA)		
6	RAHAMIM O. (ISR)		
7	PROKOP A. (AUT)		
8	IVANOV K. (UKR)		

49	GREENBANK J. (AUS)	57	GREENBANK J. (AUS)
50	RAHAMIM O. (ISR)	73	GREENBANK J. (AUS)
51	KORVAL M. (FRA)		
52	SOROCHAN A. (UKR)		
53	AHARON O. (ISR)		
54	NOEL K. (FRA)		
55	LOJANIC M. (SRB)		
56	ITSHAK Y. (ISR)		
57	GREENBANK J. (AUS)		
58	SOROCHAN A. (UKR)		
59	NOEL K. (FRA)		
60	ITSHAK Y. (ISR)		
61	MAJOR A. (HUN)		
62	BAKHTIYOR A. (USA)		
63	DUDAS M. (HUN)		
64	BAJTOS J. (SVK)		
65	FIKS E. (ISR)		
66	KOVACS A. (HUN)		
67	DUDAS M. (HUN)		
68	BAJTOS J. (SVK)		
69	FIKS E. (ISR)		
70	KORVAL M. (FRA)		
71	AHARON O. (ISR)		
72	LOJANIC M. (SRB)		
73	GREENBANK J. (AUS)		
74	NOEL K. (FRA)		
75	FIKS E. (ISR)		
76	LOJANIC M. (SRB)		
77	ITSHAK Y. (ISR)		
78	SOROCHAN A. (UKR)		
79	NOEL K. (FRA)		

POOL B

9	KORVAL Meane	FRA
10	LANTUSHENKO Klym	UKR
11	SORKIN Robert	ISR
12	UVEGES Attila	HUN
13	DUMONT Manoah	FRA
14	LOWENSTEIN Yuval Odin	ISR
15	KOVACS Attila	HUN
16	BAKHTIYOR Amin	USA
17	ZDANOWSKI Eryk	POL
18	SOROCHAN Artem	UKR
19	ANASTASOPOULOS Adam	GRE

9	KORVAL M. (FRA)	37	KORVAL M. (FRA)
10	SIMAN TOV D. (ISR)	38	UVEGES A. (HUN)
11	KAMINSKY A. (UKR)	39	KOVACS A. (HUN)
12	UVEGES A. (HUN)	40	SOROCHAN A. (UKR)
13	DUMONT M. (FRA)		
14	KOVACS A. (HUN)		
15	BAKHTIYOR A. (USA)		
16	SOROCHAN A. (UKR)		
17	GABOR A. (HUN)		
18	AHARON O. (ISR)		
19	OSMANOV Alim		
20	ROSU Y. (ISR)		
21	NOEL K. (FRA)		
22	DUDAS M. (HUN)		
23	BEN SAAD Firas		
24	KLODA Gal		
25	LAUTER Viktor		
26	JOST Kimi		

51	KORVAL M. (FRA)	53	AHARON O. (ISR)
52	SOROCHAN A. (UKR)	54	NOEL K. (FRA)
53	AHARON O. (ISR)	55	LOJANIC M. (SRB)
54	NOEL K. (FRA)	56	ITSHAK Y. (ISR)
55	LOJANIC M. (SRB)	57	GREENBANK J. (AUS)
56	ITSHAK Y. (ISR)	58	SOROCHAN A. (UKR)
57	GREENBANK J. (AUS)	59	NOEL K. (FRA)
58	SOROCHAN A. (UKR)	60	ITSHAK Y. (ISR)
59	NOEL K. (FRA)	61	MAJOR A. (HUN)
60	ITSHAK Y. (ISR)	62	BAKHTIYOR A. (USA)
61	MAJOR A. (HUN)	63	DUDAS M. (HUN)
62	BAKHTIYOR A. (USA)	64	BAJTOS J. (SVK)
63	DUDAS M. (HUN)	65	FIKS E. (ISR)
64	BAJTOS J. (SVK)	66	KOVACS A. (HUN)
65	FIKS E. (ISR)	67	DUDAS M. (HUN)
66	KOVACS A. (HUN)	68	BAJTOS J. (SVK)
67	DUDAS M. (HUN)	69	FIKS E. (ISR)
68	BAJTOS J. (SVK)	70	KORVAL M. (FRA)
69	FIKS E. (ISR)	71	AHARON O. (ISR)
70	KORVAL M. (FRA)	72	LOJANIC M. (SRB)
71	AHARON O. (ISR)	73	GREENBANK J. (AUS)
72	LOJANIC M. (SRB)	74	NOEL K. (FRA)
73	GREENBANK J. (AUS)	75	FIKS E. (ISR)
74	NOEL K. (FRA)	76	LOJANIC M. (SRB)
75	FIKS E. (ISR)	77	ITSHAK Y. (ISR)
76	LOJANIC M. (SRB)	78	SOROCHAN A. (UKR)
77	ITSHAK Y. (ISR)		
78	SOROCHAN A. (UKR)		
79	NOEL K. (FRA)		

POOL C

17	GABOR Aron	HUN
18	AHARON Oren	ISR
19	OSMANOV Alim	MDA
20	ROSU Yarin	ISR
21	KOVALOV Vadym	UKR
22	ZHONYSSOV Miras	KAZ
23	NOEL Kylian	FRA
24	DUBINA Hlib	UKR
25	DUDAS Medard	HUN
26	BEN SAAD Firas	AUT
27	KLODA Gal	ISR
28	LAUTER Viktor	HUN
29	JOST Kimi	AUS

17	GABOR A. (HUN)	41	AHARON O. (ISR)
18	AHARON O. (ISR)	42	ROSU Y. (ISR)
19	OSMANOV Alim	43	NOEL K. (FRA)
20	ROSU Y. (ISR)	44	KLODA G. (ISR)
21	NOEL K. (FRA)		
22	DUBINA Hlib		
23	DUDAS Medard		
24	BEN SAAD Firas		
25	KLODA Gal		
26	LAUTER Viktor		
27	JOST Kimi		

53	AHARON O. (ISR)	55	LOJANIC M. (SRB)
54	NOEL K. (FRA)	56	ITSHAK Y. (ISR)
55	LOJANIC M. (SRB)	57	GREENBANK J. (AUS)
56	ITSHAK Y. (ISR)	58	SOROCHAN A. (UKR)
57	GREENBANK J. (AUS)	59	NOEL K. (FRA)
58	SOROCHAN A. (UKR)	60	ITSHAK Y. (ISR)
59	NOEL K. (FRA)	61	MAJOR A. (HUN)
60	ITSHAK Y. (ISR)	62	BAKHTIYOR A. (USA)
61	MAJOR A. (HUN)	63	DUDAS M. (HUN)
62	BAKHTIYOR A. (USA)	64	BAJTOS J. (SVK)
63	DUDAS M. (HUN)	65	FIKS E. (ISR)
64	BAJTOS J. (SVK)	66	KOVACS A. (HUN)
65	FIKS E. (ISR)	67	DUDAS M. (HUN)
66	KOVACS A. (HUN)	68	BAJTOS J. (SVK)
67	DUDAS M. (HUN)	69	FIKS E. (ISR)
68	BAJTOS J. (SVK)	70	KORVAL M. (FRA)
69	FIKS E. (ISR)	71	AHARON O. (ISR)
70	KORVAL M. (FRA)	72	LOJANIC M. (SRB)
71	AHARON O. (ISR)	73	GREENBANK J. (AUS)
72	LOJANIC M. (SRB)	74	NOEL K. (FRA)
73	GREENBANK J. (AUS)	75	FIKS E. (ISR)
74	NOEL K. (FRA)	76	LOJANIC M. (SRB)
75	FIKS E. (ISR)	77	ITSHAK Y. (ISR)
76	LOJANIC M. (SRB)	78	SOROCHAN A. (UKR)
77	ITSHAK Y. (ISR)		
78	SOROCHAN A. (UKR)		
79	NOEL K. (FRA)		

POOL D

25	KOKOLAYEV Ronald	ISR
26	SEDMAK Fran	CRO
27	LOJANIC Marko	SRB
28	GOC Ata Isiner	TUR
29	SHKONDIN Vladyslav	UKR
30	ZHUBATKANOV Akylyzhan	KAZ
31	KOVACS Bence	HUN
32	RASKIN Yan	UKR
33	JEGHALEF Mohammed	MAR
34	THOMSON Luke	CAN
35	STOPP Patrik	HUN
36	BAJTOS Jakub	SVK
37	RAKOTONDRAMANGA Rialy	SUI
38	ITSHAK Yonatan	ISR

25	KOKOLAYEV R. (ISR)	45	LOJANIC M. (SRB)
26	SEDMAK Fran	46	KOVACS B. (HUN)
27	LOJANIC M. (SRB)	47	JEGHALEF M. (MAR)
28	GOC Ata Isiner	48	ITSHAK Y. (ISR)
29	SHKONDIN V. (UKR)		
30	ZHUBATKANOV Akylyzhan		
31	KOVACS B. (HUN)		
32	RASKIN Y. (UKR)		
33	JEGHALEF M. (MAR)		
34	THOMSON Luke		
35	STOPP Patrik		
36	BAJTOS J. (SVK)		
37	RAKOTONDRAMANGA Rialy		
38	ITSHAK Y. (ISR)		

55	LOJANIC M. (SRB)	57	GREENBANK J. (AUS)
56	ITSHAK Y. (ISR)	58	SOROCHAN A. (UKR)
57	GREENBANK J. (AUS)	59	NOEL K. (FRA)
58	SOROCHAN A. (UKR)	60	ITSHAK Y. (ISR)
59	NOEL K. (FRA)	61	MAJOR A. (HUN)
60	ITSHAK Y. (ISR)	62	BAKHTIYOR A. (USA)
61	MAJOR A. (HUN)	63	DUDAS M. (HUN)
62	BAKHTIYOR A. (USA)	64	BAJTOS J. (SVK)
63	DUDAS M. (HUN)	65	FIKS E. (ISR)
64	BAJTOS J. (SVK)	66	KOVACS A. (HUN)
65	FIKS E. (ISR)	67	DUDAS M. (HUN)
66	KOVACS A. (HUN)	68	BAJTOS J. (SVK)
67	DUDAS M. (HUN)	69	FIKS E. (ISR)
68	BAJTOS J. (SVK)	70	KORVAL M. (FRA)
69	FIKS E. (ISR)	71	AHARON O. (ISR)
70	KORVAL M. (FRA)	72	LOJANIC M. (SRB)
71	AHARON O. (ISR)	73	GREENBANK J. (AUS)
72	LOJANIC M. (SRB)	74	NOEL K. (FRA)
73	GREENBANK J. (AUS)	75	FIKS E. (ISR)
74	NOEL K. (FRA)	76	LOJANIC M. (SRB)
75	FIKS E. (ISR)	77	ITSHAK Y. (ISR)
76	LOJANIC M. (SRB)	78	SOROCHAN A. (UKR)
77	ITSHAK Y. (ISR)		
78	SOROCHAN A. (UKR)		
79	NOEL K. (FRA)		

FINAL RESULTS		
1.	NOEL Kylian	FRA
2.	GREENBANK Jordon	AUS
3.	FIKS Eran	ISR
3.	SOROCHAN Artem	UKR
5.	ITSHAK Yonatan	ISR
5.	LOJANIC Marko	SRB
7.	AHARON Oren	ISR
7.	KORVAL Meane	FRA

REPECHAGE

61	MAJOR A. (HUN)	65	FIKS E. (ISR)
62	BAKHTIYOR A. (USA)	66	KOVACS A. (HUN)
63	DUDAS M. (HUN)	67	DUDAS M. (HUN)
64	BAJTOS J. (SVK)	68	BAJTOS J. (SVK)
65	FIKS E. (ISR)	69	FIKS E. (ISR)
66	KOVACS A. (HUN)	70	KORVAL M. (FRA)
67	DUDAS M. (HUN)	71	AHARON O. (ISR)
68	BAJTOS J. (SVK)	72	LOJANIC M. (SRB)
69	FIKS E. (ISR)	73	GREENBANK J. (AUS)
70	KORVAL M. (FRA)	74	NOEL K. (FRA)
71	AHARON O. (ISR)	75	FIKS E. (ISR)
72	LOJANIC M. (SRB)	76	LOJANIC M. (SRB)
73	GREENBANK J. (AUS)	77	ITSHAK Y. (ISR)
74	NOEL K. (FRA)	78	SOROCHAN A. (UKR)
75	FIKS E. (ISR)		
76	LOJANIC M. (SRB)		
77	ITSHAK Y. (ISR)		
78	SOROCHAN A. (UKR)		

61	MAJOR A. (HUN)	65	FIKS E. (ISR)
62	BAKHTIYOR A. (USA)	66	KOVACS A. (HUN)
63	DUDAS M. (HUN)	67	DUDAS M. (HUN)
64	BAJTOS J. (SVK)	68	BAJTOS J. (SVK)
65	FIKS E. (ISR)	69	FIKS E. (ISR)
66	KOVACS A. (HUN)	70	KORVAL M. (FRA)
67	DUDAS M. (HUN)	71	AHARON O. (ISR)
68	BAJTOS J. (SVK)	72	LOJANIC M. (SRB)
69	FIKS E. (ISR)	73	GREENBANK J. (AUS)
70	KORVAL M. (FRA)	74	NOEL K. (FRA)
71	AHARON O. (ISR)	75	FIKS E. (ISR)
72	LOJANIC M. (SRB)	76	LOJANIC M. (SRB)
73	GREENBANK J. (AUS)	77	ITSHAK Y. (ISR)
74	NOEL K. (FRA)	78	SOROCHAN A. (UKR)
75	FIKS E. (ISR)		
76	LOJANIC M. (SRB)		
77	ITSHAK Y. (ISR)		
78	SOROCHAN A. (UKR)		

69	FIKS E. (ISR)	75	FIKS E. (ISR)
70	KORVAL M. (FRA)	76	LOJANIC M. (SRB)
71	AHARON O. (ISR)	77	ITSHAK Y. (ISR)
72	LOJANIC M. (SRB)	78	SOROCHAN A. (UKR)
73	GREENBANK J. (AUS)		
74	NOEL K. (FRA)		
75	FIKS E. (ISR)		
76	LOJANIC M. (SRB)		
77	ITSHAK Y. (ISR)		
78	SOROCHAN A. (UKR)		



# Paks Junior European Cup 2023

Hungary, Paks, 8-9 Jul 2023

**-73 kg**  
Juniors (67)

**POOL A**

	ADORJANI Gergely	HUN	1	ADORJANI G. (HUN)
	ANTE LJ Srdjan	SRB	2	ANTE LJ S. (SRB)
	NAPRUDNIK Lenz	AUT	3	NAPRUDNIK L. (AUT)
	ELLIOTT Samuel	GBR	4	ELLIOTT S. (GBR)
	BIBITKO Itay	ISR	5	BIBITKO I. (ISR)
	GROPA Vlad	MDA	6	GROPA V. (MDA)
	DUISENKHAN Yersultan	KAZ	7	DUISENKHAN Y. (KAZ)
	KARPUKOV Arthur	CAN	8	KARPUKOV A. (CAN)
	PREVE Eliot	FRA	9	PREVE E. (FRA)
	BARCZIKAY Akos	HUN	10	BARCZIKAY A. (HUN)
	BAKHTIYOR Romin	USA	11	BAKHTIYOR R. (USA)
	MALONKIN Bohdan	UKR	12	MALONKIN B. (UKR)
	SEMENYUK Yuriy	CAN	13	SEMENYUK Y. (CAN)
	TOPALOVIC Darko	BIH	14	TOPALOVIC D. (BIH)
	NURSHAYEV Nuryim	KAZ	15	NURSHAYEV N. (KAZ)
	VISEL Ido	ISR	16	VISEL I. (ISR)

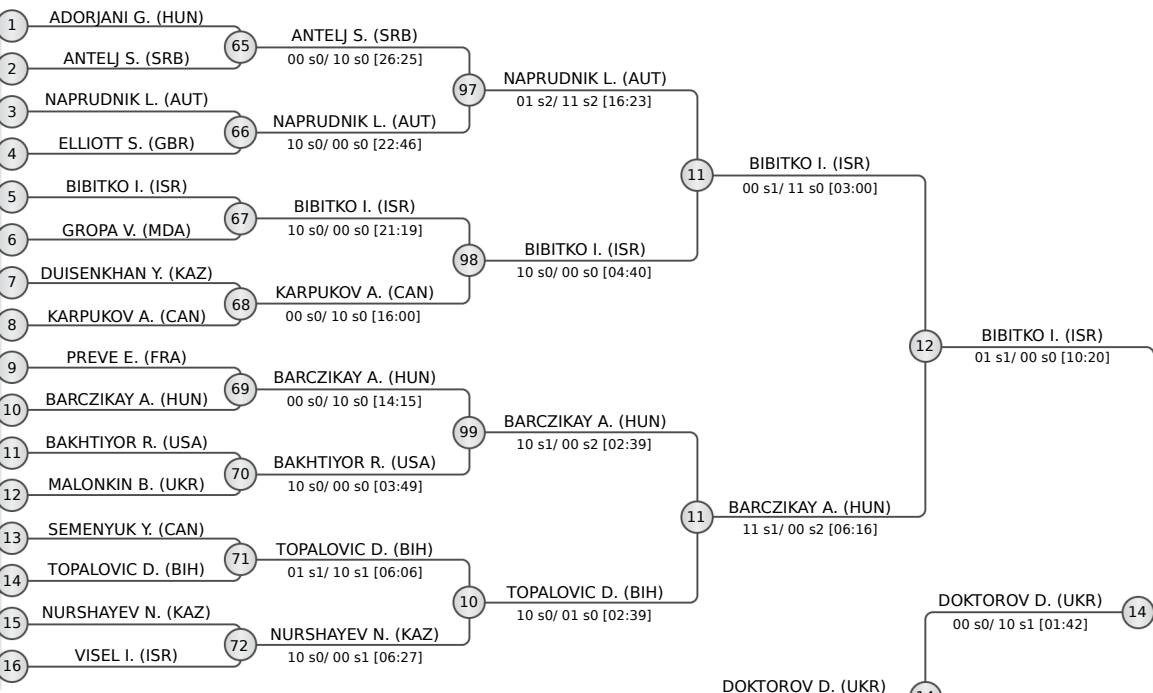

**POOL B**

	KULIESHOV Nazar	UKR	17	KULIESHOV N. (UKR)
	PARZHAN Baktiyar	KAZ	18	PARZHAN B. (KAZ)
	TOTH Barna	HUN	19	TOTH B. (HUN)
	NEUMANN Eryk	GBR	20	NEUMANN E. (GBR)
	IVOVIC Filip	SRB	21	IVOVIC F. (SRB)
	WALLACE Kai	USA	22	WALLACE K. (USA)
	GAGNON Olivier	CAN	23	GAGNON O. (CAN)
	SANTA Botond	HUN	24	SANTA B. (HUN)
	DAVIES Luke	GBR	25	DAVIES L. (GBR)
	POMAZI Dominik	HUN	26	POMAZI D. (HUN)
	BARRIONUEVO Esteban	ARG	27	BARRIONUEVO E. (ARG)
	LAVRSEN Bertil	DEN	28	LAVRSEN B. (DEN)
	DOKTOROV Denys	UKR	29	DOKTOROV D. (UKR)
	STARCENCO Timofei	ISR	30	STARCENCO T. (ISR)
	NGOMBI Jeremie	CAN	31	TOYOSHIMA K. (AUS)
	TOYOSHIMA Kohsei	AUS	31	TOYOSHIMA K. (AUS)
	HANCOCK Daron	ISL	32	HANCOCK D. (ISL)

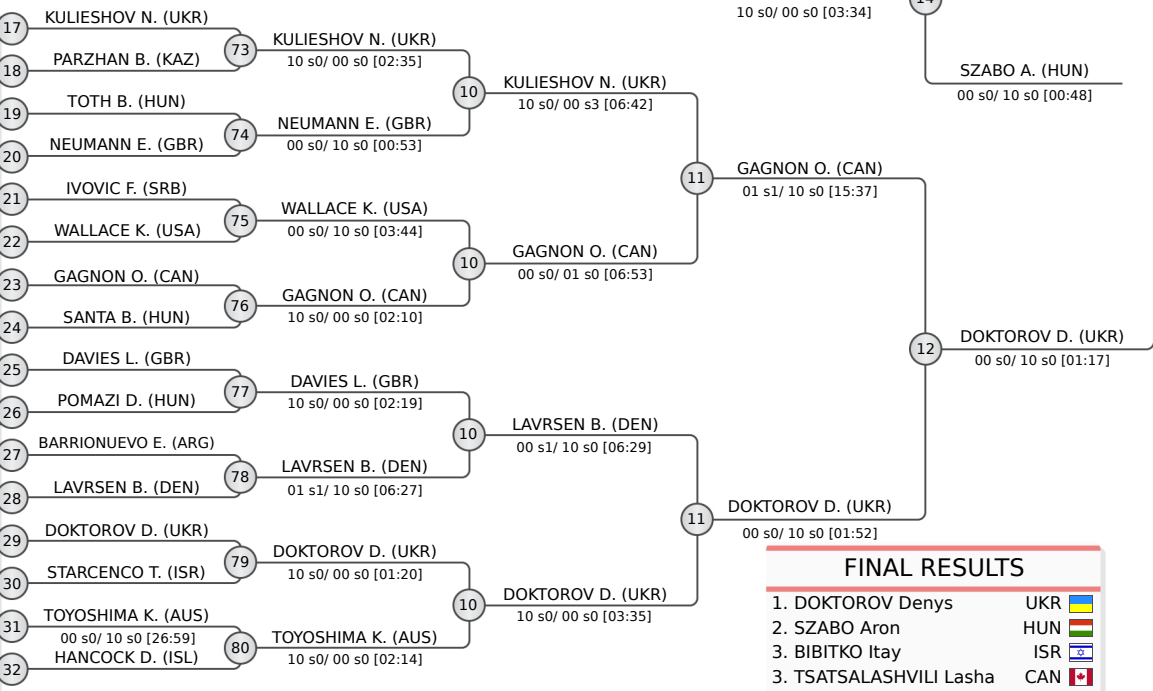

FINAL RESULTS		
1.	DOKTOROV Denys	UKR
2.	SZABO Aron	HUN
3.	BIBITKO Itay	ISR
3.	TSATSALASHVILI Lasha	CAN
5.	TYRRELL Rory	GBR
5.	NAPRUDNIK Lenz	AUT
7.	SAMARCHENKO Artiom	ISR
7.	GAGNON Olivier	CAN

**REPECHAGE**

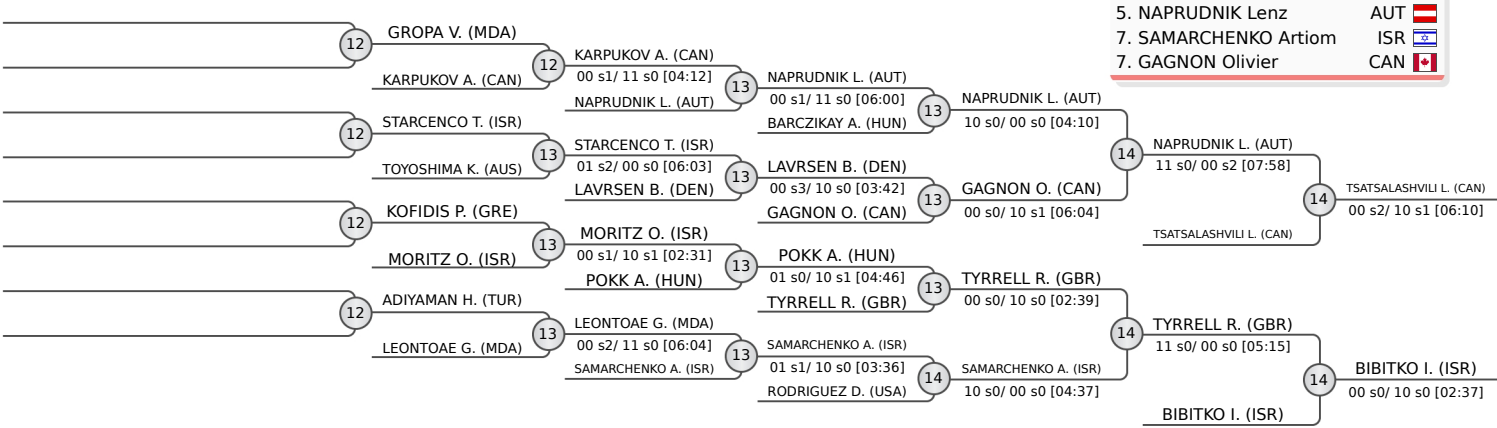



# Paks Junior European Cup 2023

Hungary, Paks, 8-9 Jul 2023

**-73 kg**  
Juniors (67)

POOL C

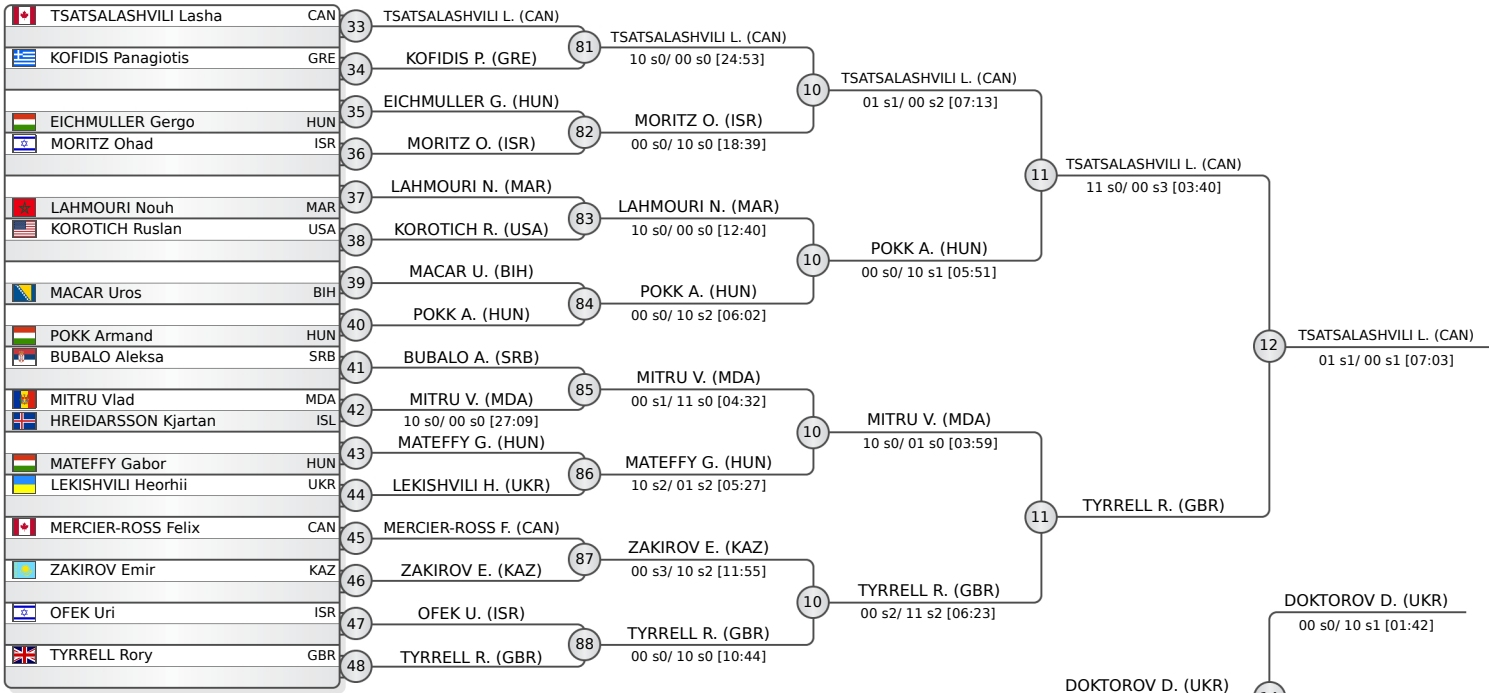

POOL D

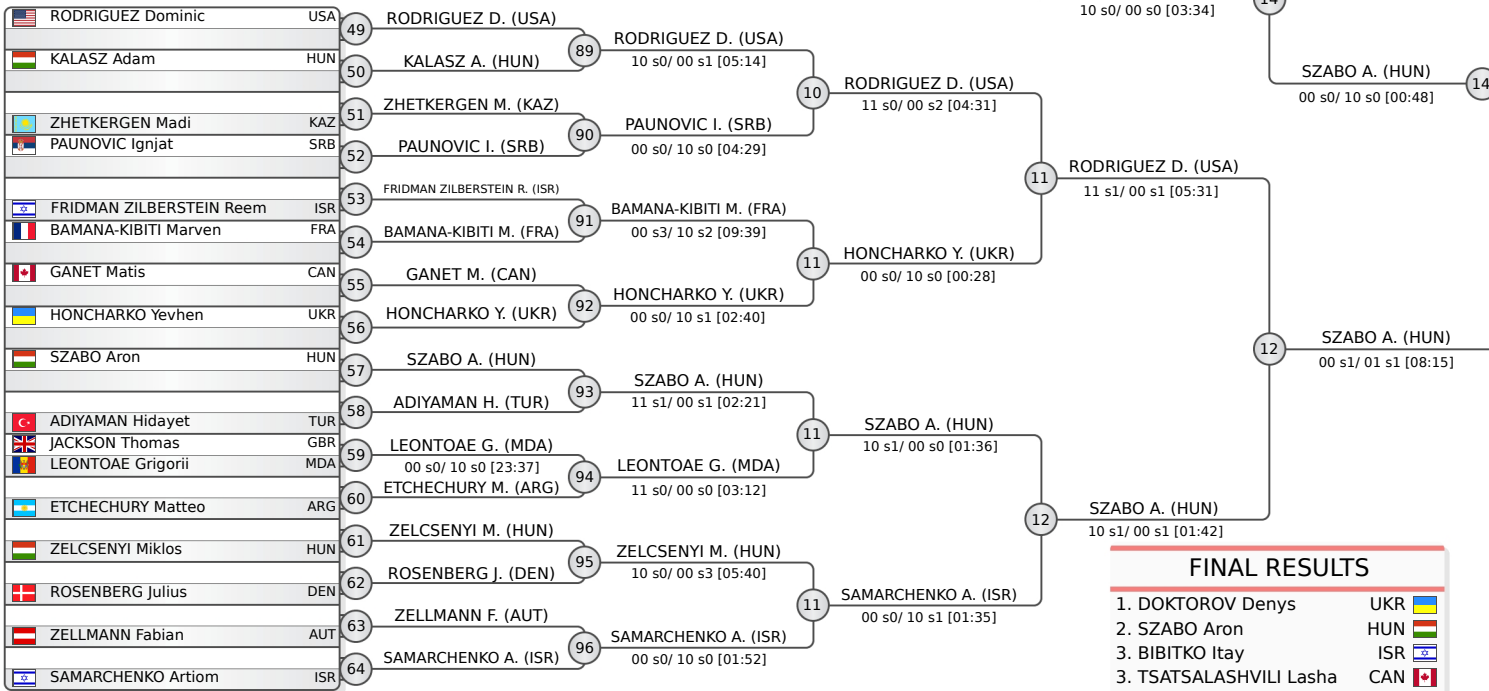

FINAL RESULTS		
1.	DOKTOROV Denys	UKR
2.	SZABO Aron	HUN
3.	BIBITKO Itay	ISR
3.	TSATSALASHVILI Lasha	CAN
5.	TYRRELL Rory	GBR
5.	NAPRUDNIK Lenz	AUT
7.	SAMARCHENKO Artiom	ISR
7.	GAGNON Olivier	CAN

REPECHAGE

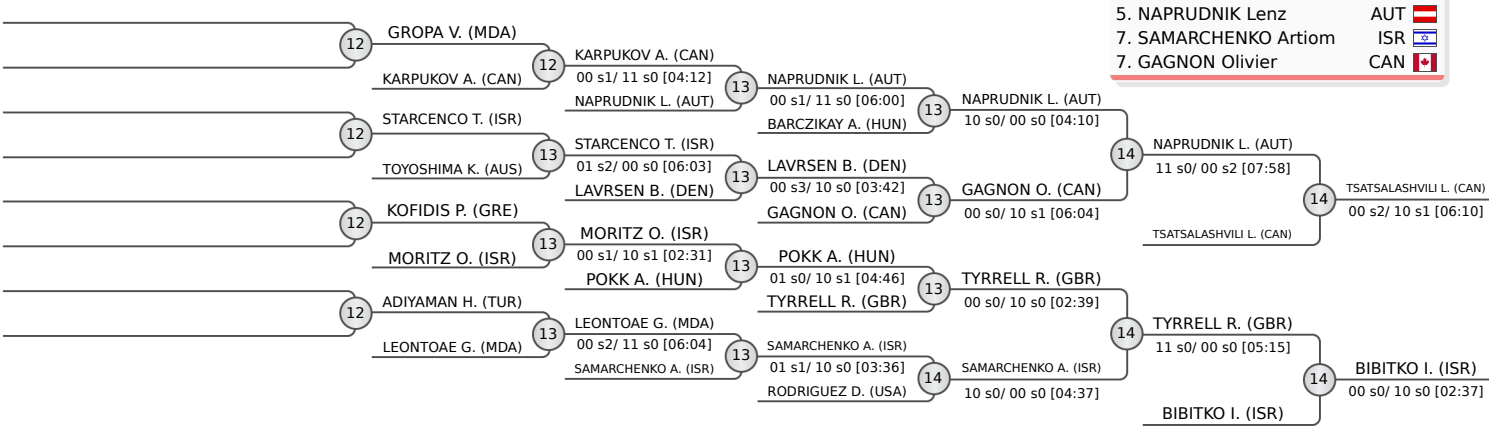





# Paks Junior European Cup 2023

Hungary, Paks, 8-9 Jul 2023

**-81 kg**  
Juniors (49)

**POOL A**

1	MELADZE Jumber	CAN
2	ASKHAM Džoni	DEN
3	SIMIN Mihajlo	SRB
4	JAKSA Akos	HUN
5	OULEVEY Thien	SUI
6	PFEIFENBERGER Eric	AUT
7	OKOYE Jason	FRA
8	TOKHTAMYSH Oleksandr	UKR
9	SILOT Johan	USA
10	AGRONOV Yaniv	ISR
11	ISAKSSON Mikael	ISL
12	KAPSOUROU Marios	GRE
13	MAJOR Adam	HUN

1	MELADZE J. (CAN)	33	MELADZE J. (CAN)
2	SIMIN M. (SRB)	01 s3/ 11 s1 [16:54]	01 s0/ 00 s0 [01:59]
3	JAKSA A. (HUN)	34	OULEVEY T. (SUI)
4	OULEVEY T. (SUI)	01 s1/ 00 s1 [05:59]	00 s1/ 10 s1 [03:32]
5	OKOYE J. (FRA)	35	OKOYE J. (FRA)
6	SILOT J. (USA)	00 s0/ 10 s0 [01:20]	01 s2/ 00 s2 [15:48]
7	AGRONOV Y. (ISR)	36	AGRONOV Y. (ISR)
8	MAJOR A. (HUN)	10 s0/ 00 s1 [02:27]	10 s1/ 00 s2 [05:14]
	00 s0/ 10 s0 [02:13]		

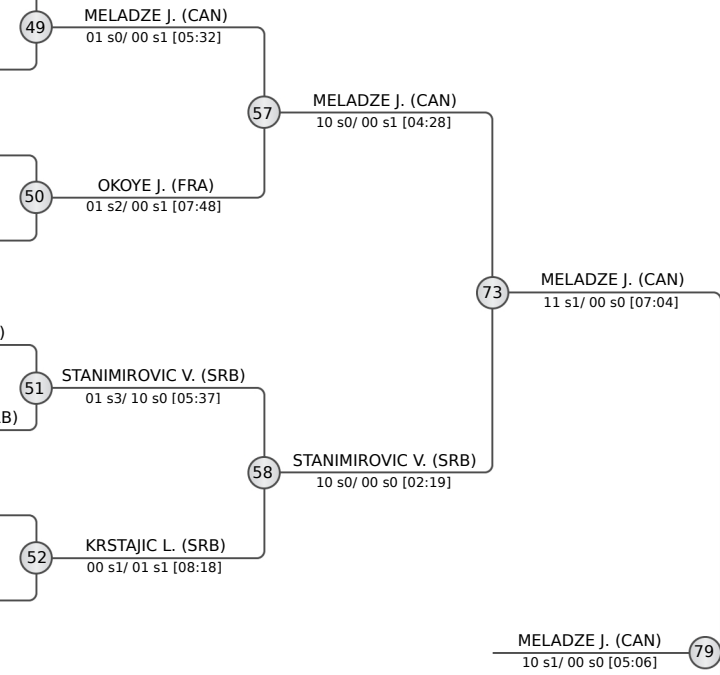

**POOL B**

9	TSCHILIKIN Leon	AUT
10	KUCHAVA David	UKR
11	DEATH Jamie	GBR
12	STANIMIROVIC Vukan	SRB
13	JABRANE Adam	MAR
14	LAKK Zsombor	HUN
15	DEMETER Bendeguz	HUN
16	ARGOV Or	ISR
17	GAINA Mario-Antonio	MDA
18	AIMUKHAMBETOV Daryn	KAZ
19	KRSTAJIC Luka	SRB
20	KISS Levente	HUN

9	TSCHILIKIN L. (AUT)	37	TSCHILIKIN L. (AUT)
10	KUCHAVA D. (UKR)	10 s2/ 00 s1 [04:16]	10 s0/ 00 s1 [05:07]
11	STANIMIROVIC V. (SRB)	38	STANIMIROVIC V. (SRB)
12	LAKK Z. (HUN)	00 s0/ 10 s1 [02:10]	10 s0/ 00 s2 [06:26]
13	DEMETER B. (HUN)	39	GAINA M. (MDA)
14	GAINA M. (MDA)	00 s1/ 10 s0 [02:49]	01 s0/ 10 s0 [07:22]
15	KRSTAJIC L. (SRB)	40	KRSTAJIC L. (SRB)
16	KISS L. (HUN)	00 s2/ 11 s0 [07:41]	10 s2/ 00 s2 [06:37]

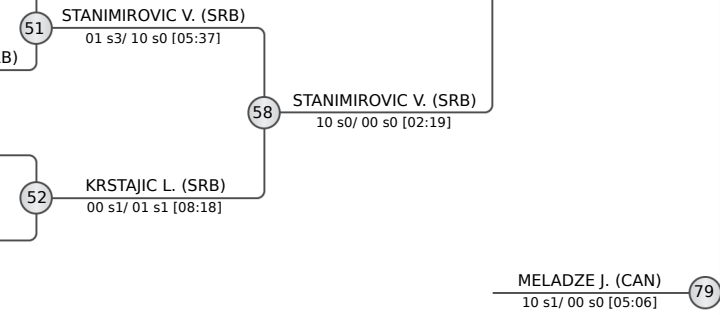

**POOL C**

17	DEMETER Marcell	HUN
18	ADUAKHATOV Adil	KAZ
19	JANKOVIC Juraj	SVK
20	KHAMMO Viacheslav	UKR
21	KRUZHILIN Nikita	ISR
22	DOUMAS Stavros	GRE
23	SZTANKO Daniel	HUN
24	ARNARSSON Bodvar	ISL
25	VON SCHRADER Ruben	AUT
26	GRIBINET Ciprian	MDA
27	VAGO Levente	HUN
28	BOŽIĆ Luka	SRB

17	DEMETER M. (HUN)	41	DEMETER M. (HUN)
18	JANKOVIC J. (SVK)	01 s1/ 10 s0 [07:56]	10 s0/ 00 s0 [04:29]
19	KHAMMO V. (UKR)	42	DOUMAS S. (GRE)
20	DOUMAS S. (GRE)	00 s3/ 11 s0 [04:20]	00 s3/ 11 s0 [04:20]
21	SZTANKO D. (HUN)	43	SZTANKO D. (HUN)
22	VON SCHRADER R. (AUT)	00 s1/ 10 s0 [01:21]	10 s0/ 00 s0 [02:07]
23	GRIBINET C. (MDA)	44	GRIBINET C. (MDA)
24	VAGO L. (HUN)	10 s0/ 01 s0 [05:24]	10 s0/ 00 s0 [02:27]

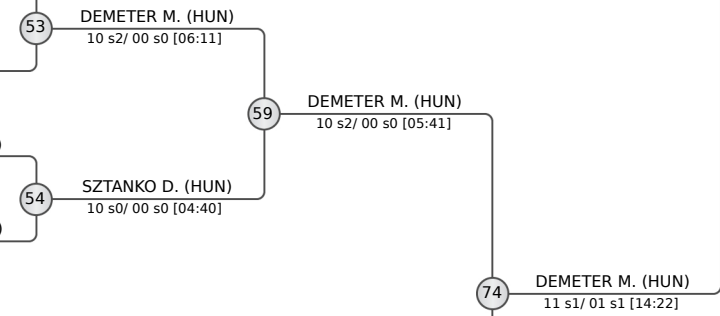

**POOL D**

25	ZDRALE Lazar	BIH
26	DEGALLIER Yanis	SUI
27	BORCHASHVILLI Magamed	AUT
28	ASHEN Jake	GBR
29	MILANOV Djordje	SRB
30	DOBROSY Almos	HUN
31	GIORDANO Matteo	FRA
32	ANDRIAMANANA Faniry-Michael	CAN
33	ROTTENSTEIN Botond	HUN
34	BEREZHNYYI Rostyslav	UKR
35	KOROTICH Danylo	USA
36	CHRISTIANSEN Emil	DEN

25	ZDRALE L. (BIH)	45	BORCHASHVILLI M. (AUT)
26	BORCHASHVILLI M. (AUT)	00 s1/ 10 s1 [04:32]	00 s1/ 10 s1 [07:44]
27	ASHEN J. (GBR)	46	MILANOV D. (SRB)
28	MILANOV D. (SRB)	00 s1/ 10 s0 [05:01]	10 s0/ 00 s1 [05:09]
29	DOBROSY A. (HUN)	47	GIORDANO M. (FRA)
30	GIORDANO M. (FRA)	10 s1/ 00 s3 [10:26]	10 s1/ 00 s3 [10:26]
31	ANDRIAMANANA F. (CAN)	48	BEREZHNYYI R. (UKR)
32	ROTTENSTEIN B. (HUN)	00 s0/ 01 s1 [06:54]	10 s0/ 00 s3 [03:43]
33	BEREZHNYYI R. (UKR)	01 s1/ 00 s2 [06:42]	
34	KOROTICH D. (USA)	49	CHRISTIANSEN E. (DEN)
35	CHRISTIANSEN E. (DEN)	10 s0/ 00 s3 [03:43]	

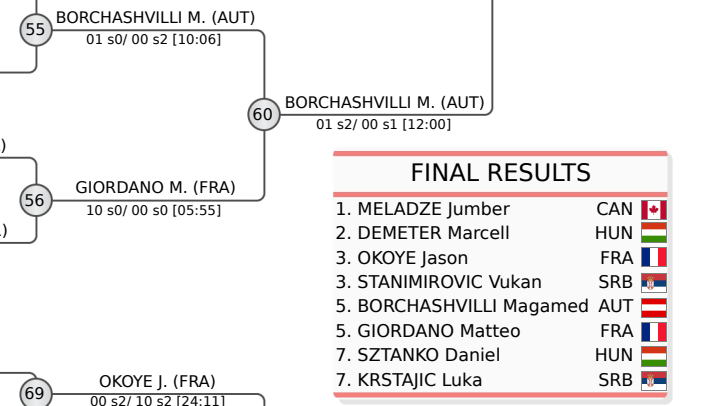

FINAL RESULTS		
1.	MELADZE Jumber	CAN
2.	DEMETER Marcell	HUN
3.	OKOYE Jason	FRA
3.	STANIMIROVIC Vukan	SRB
5.	BORCHASHVILLI Magamed	AUT
5.	GIORDANO Matteo	FRA
7.	SZTANKO Daniel	HUN
7.	KRSTAJIC Luka	SRB

**REPECHAGE**

61	SIMIN M. (SRB)
62	LAKK Z. (HUN)
63	JANKOVIC J. (SVK)
64	ZDRALE L. (BIH)

61	SIMIN M. (SRB)	65	OULEVEY T. (SUI)
62	LAKK Z. (HUN)	66	LAKK Z. (HUN)
63	JANKOVIC J. (SVK)	67	JANKOVIC J. (SVK)
64	ZDRALE L. (BIH)	68	MILANOV D. (SRB)

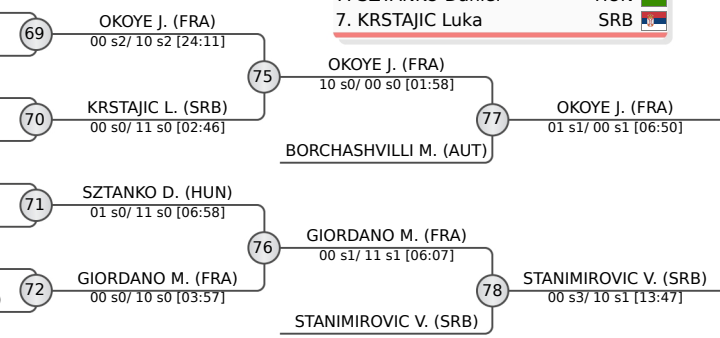



# Paks Junior European Cup 2023

Hungary, Paks, 8-9 Jul 2023

## -90 kg

Juniors (18)

POOL A

	KUTENKOV Ivan	UKR
	JOVANOVIC Marko	SRB
	MARCHENKO Andrii	UKR
	LIUBIMOVSKI Daniel	USA

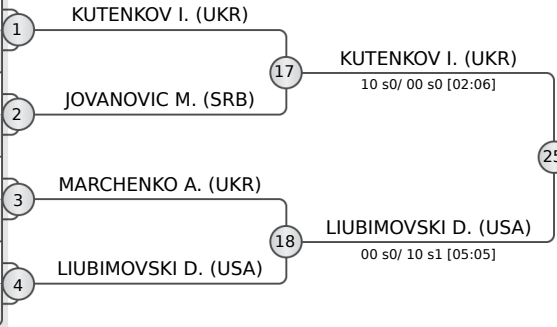

POOL B

	ALI David	FRA
	BOTOS Noel	HUN
	BULAJA Milan	SRB
	SCHWARZL Tim	AUT
	BRAZANI Gal	ISR

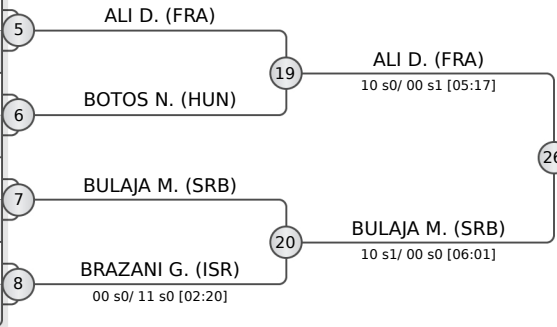

POOL C

	CUREAU Baptiste	FRA
	HJALTASON Skarphedinn	ISL
	MIKLOSVOLGYI Daniel	HUN
	WEITZBAUER Niklas	AUT
	GHIMBOVSCHI Vadim	MDA

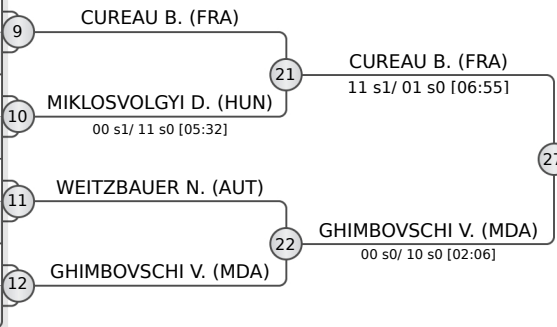

POOL D

	RADULJ Miljan	SRB
	LAKOS Mate	HUN
	BLOESCH Morgan	SUI
	TYNYSHKALI Nurdauren	KAZ

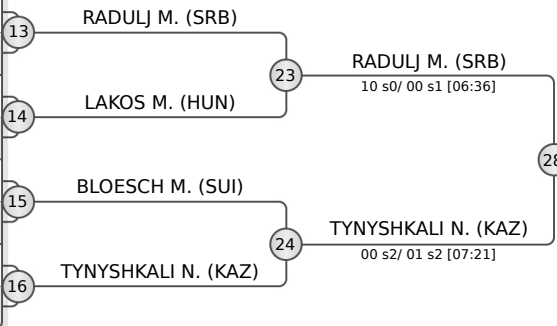

REPECHAGE

JOVANOVIC M. (SRB)	29	JOVANOVIC M. (SRB)	33
BOTOS N. (HUN)	30	BULAJA M. (SRB)	34
MIKLOSVOLGYI D. (HUN)	31	GHIMBOVSCHI V. (MDA)	35
LAKOS M. (HUN)	32	LAKOS M. (HUN)	36

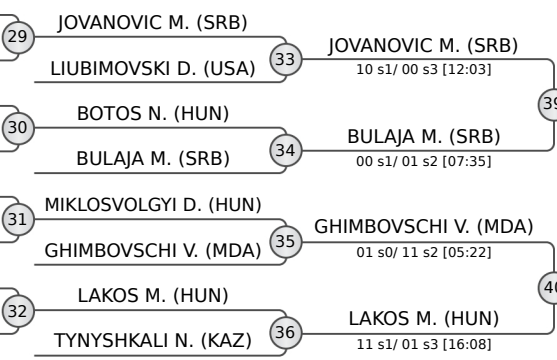

RADULJ M. (SRB) [00 s3/ 10 s0 [05:15]] (43)

RADULJ M. (SRB) [00 s1/ 01 s1 [07:37]] (38)

FINAL RESULTS	
1. RADULJ Miljan	SRB
2. KUTENKOV Ivan	UKR
3. GHIMBOVSCHI Vadim	MDA
3. CUREAU Baptiste	FRA
5. ALI David	FRA
7. JOVANOVIC Marko	SRB
7. BULAJA Milan	SRB
7. LAKOS Mate	HUN



# Paks Junior European Cup 2023

Hungary, Paks, 8-9 Jul 2023

## -100 kg

Juniors (10)

### POOL A

	ANGLIONIN Mathias	FRA
	RAZGHONOV Maksym	UKR
	DJORDJEVIC Djordjije	SRB

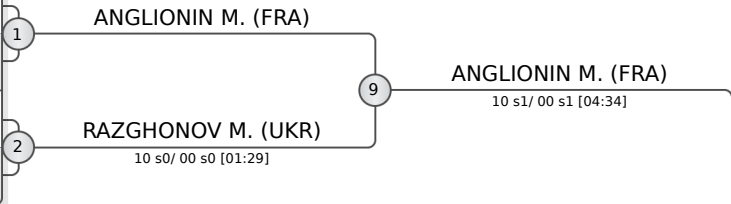

### POOL B

	DJURISIC Ognjen	SRB
	ILLMER Hubert	AUT

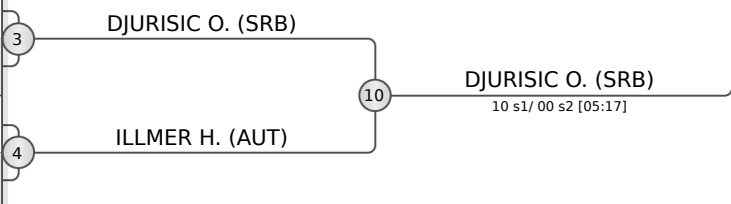

### POOL C

	BORDIN Maxence	FRA
	KENDERESI Peter	HUN
	BRAZHNYK Norman	CAN

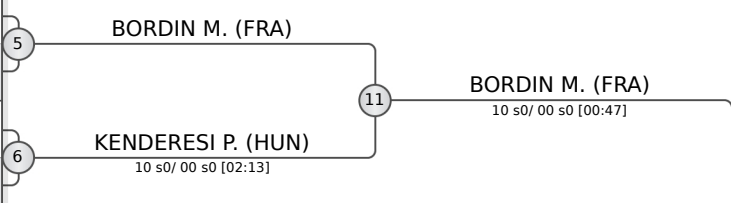

### POOL D

	NURIEV Kariim	UKR
	SIMIC Stefan	SRB

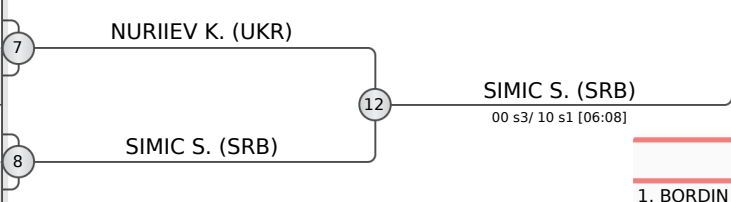

### REPECHAGE

RAZGHONOV M. (UKR)	13
ILLMER H. (AUT)	14
KENDERESI P. (HUN)	15
NURIEV K. (UKR)	16

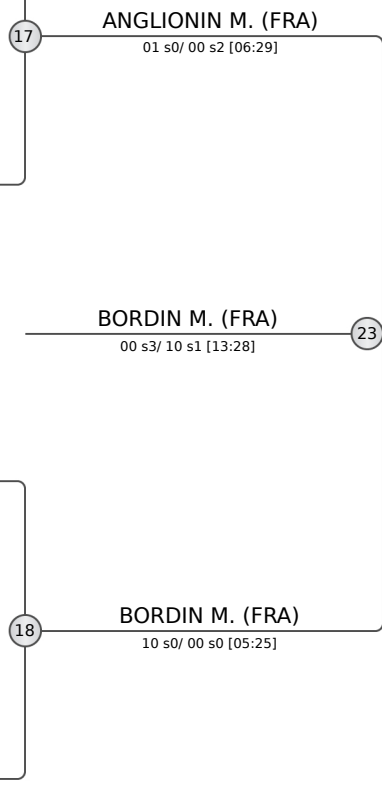
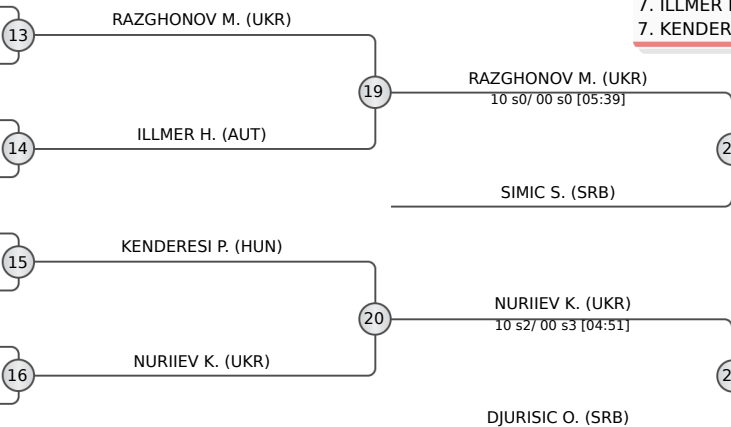

FINAL RESULTS		
1.	BORDIN Maxence	FRA
2.	ANGLIONIN Mathias	FRA
3.	NURIEV Kariim	UKR
3.	RAZGHONOV Maksym	UKR
5.	DJURISIC Ognjen	SRB
5.	SIMIC Stefan	SRB
7.	ILLMER Hubert	AUT
7.	KENDERESI Peter	HUN



# Paks Junior European Cup 2023

Hungary, Paks, 8-9 Jul 2023

## + 100 kg

Juniors (12)

POOL A

	MESSE A BESSONG John Jr	CAN
	LAKATOS Gyorgy	HUN
	WELLER-HENRY James	GBR

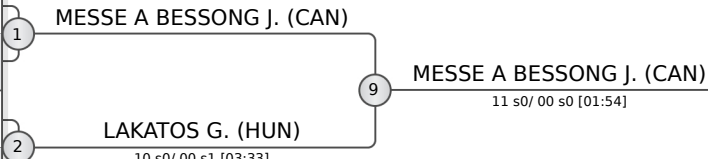

POOL B

	DOBOS Levente	HUN
	HRYBYK Mykola	UKR
	AZIANI Zakariae	MAR

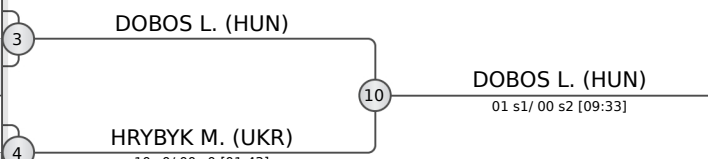

POOL C

	GOMES DA SILVA Mathys	FRA
	BALOGH Janos	HUN
	YAROSHENKO Fedir	UKR

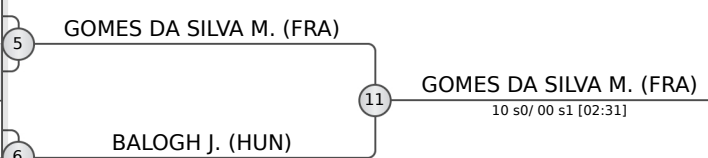

POOL D

	EDE Daniel	GBR
	SCHARNER Oliver	AUT
	MATVEEV Alexandr	MDA

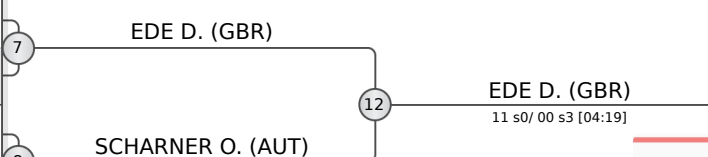

REPECHAGE

LAKATOS G. (HUN)	13
HRYBYK M. (UKR)	14
BALOGH J. (HUN)	15
SCHARNER O. (AUT)	16

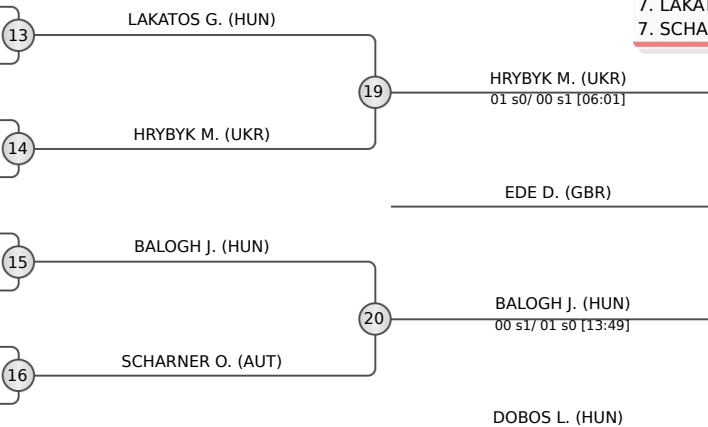

MESSE A BESSONG J. (CAN) 23  
11 s0/ 00 s0 [05:45]

GOMES DA SILVA M. (FRA) 18  
10 s0/ 00 s1 [02:30]

EDE D. (GBR) 12  
11 s0/ 00 s3 [04:19]

HRYBYK M. (UKR) 21  
01 s0/ 00 s1 [06:01]

HRYBYK M. (UKR) 21  
01 s0/ 00 s1 [06:01]

BALOGH J. (HUN) 20  
00 s1/ 01 s0 [13:49]

DOBOS L. (HUN) 22  
00 s1/ 01 s0 [13:49]

### FINAL RESULTS

1.	MESSE A BESSONG John Jr	CAN	
2.	GOMES DA SILVA Mathys	FRA	
3.	HRYBYK Mykola	UKR	
3.	DOBOS Levente	HUN	
5.	EDE Daniel	GBR	
5.	BALOGH Janos	HUN	
7.	LAKATOS Gyorgy	HUN	
7.	SCHARNER Oliver	AUT	





# Paks Junior European Cup 2023

Hungary, Paks, 8-9 Jul 2023

## -48 kg

Juniors (15)

### POOL A

	CUQ Pauline	FRA
	TURMEL Marie-Lune	CAN
	MUNTSUROVA Tanzila	AUT

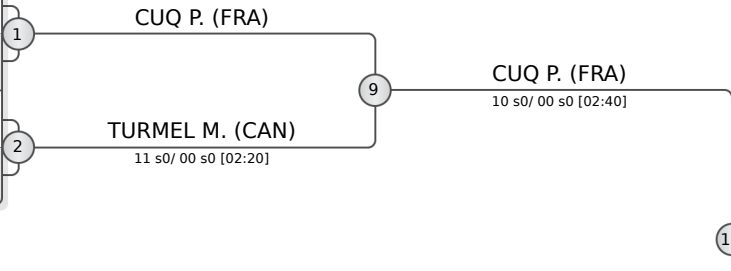

### POOL B

	RICHARD Clementine	FRA
	QUACH Heidi	CAN
	KATENDI NZUZI Fina Pamedie	FRA
	VASKA Fanni	HUN

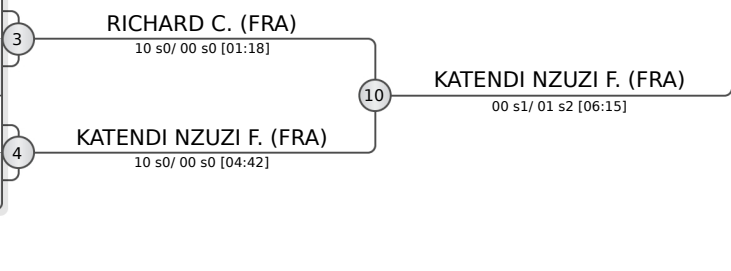

### POOL C

	KOSZEGI Rebeka Rita	HUN
	MEDILO Charlize Isabelle	CAN
	SZELECZKI Szabina	HUN
	PEHERSTORFER Lisa	AUT

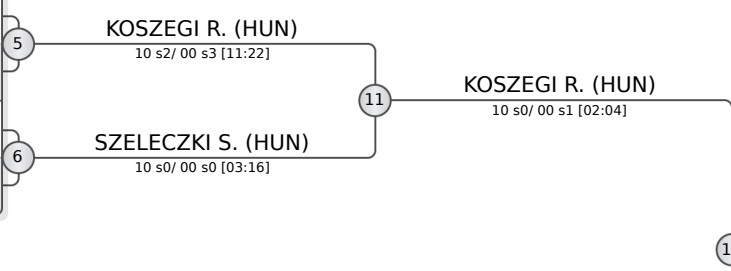

### POOL D

	SUPERSON Anastasiia	UKR
	FIELDER Anneliese	AUS
	ANNIS Morgane	FRA
	STEGENA Samanta	SUI

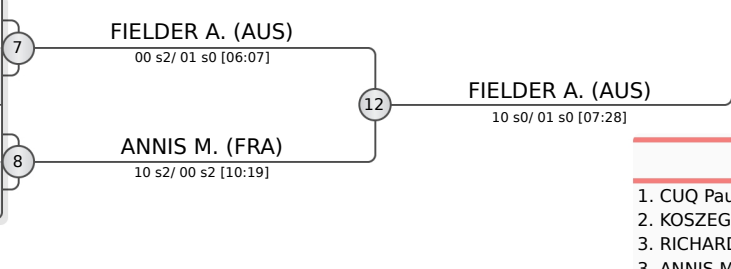

FINAL RESULTS		
1.	CUQ Pauline	FRA
2.	KOSZEGI Rebeka Rita	HUN
3.	RICHARD Clementine	FRA
3.	ANNIS Morgane	FRA
5.	FIELDER Anneliese	AUS
5.	KATENDI NZUZI Fina Pamedie	FRA
7.	TURMEL Marie-Lune	CAN
7.	MEDILO Charlize Isabelle	CAN

### REPECHAGE

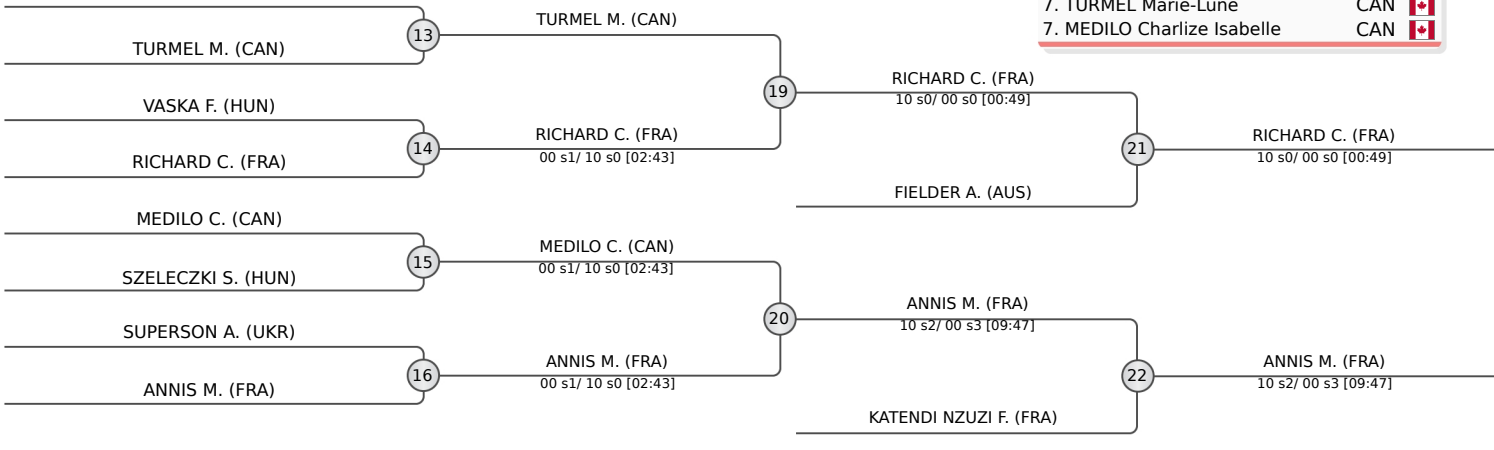



# Paks Junior European Cup 2023

Hungary, Paks, 8-9 Jul 2023

## -52 kg

Juniors (18)

POOL A

	KELLER Rebeka	HUN
	VODIANNA Melaniia	UKR
	MAMIRA Luca	HUN
	ALAMO Valentina	ARG
	BOURIHANE Sarra	CAN

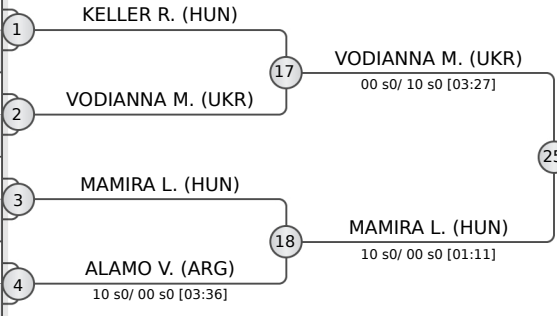

POOL B

	BEATON Evelyn	CAN
	VEG Luca	HUN
	BIRRI Madeleine	GBR
	CHANET Hajar	MAR

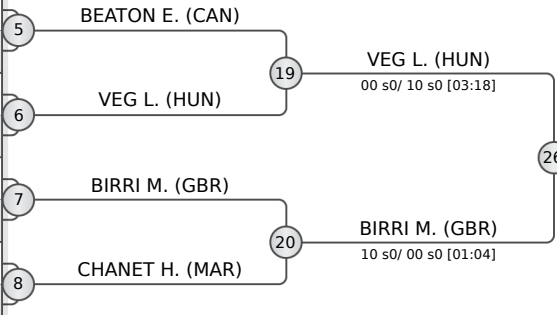

POOL C

	JENMAN Charlotte	GBR
	TSIKKOU Stella	HUN
	SICKINGER Larissa	AUT
	SLOBODENIUK Alina	UKR
	RACZ Lea	HUN

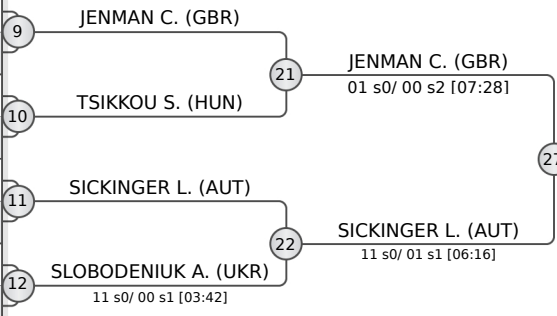

POOL D

	BERES Lea	FRA
	LOUET Violette	CAN
	LAVY Ruth	ISR
	SZABO Cseperke	HUN

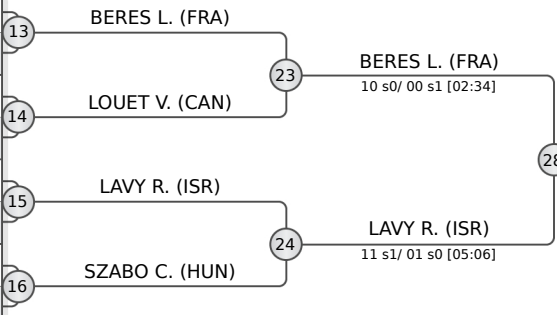

REPECHAGE

ALAMO V. (ARG)	29	ALAMO V. (ARG)	33	VODIANNA M. (UKR)
BEATON E. (CAN)	30	BEATON E. (CAN)	34	BEATON E. (CAN)
TSIKKOU S. (HUN)	31	TSIKKOU S. (HUN)	35	SICKINGER L. (AUT)
LOUET V. (CAN)	32	LOUET V. (CAN)	36	LAVY R. (ISR)

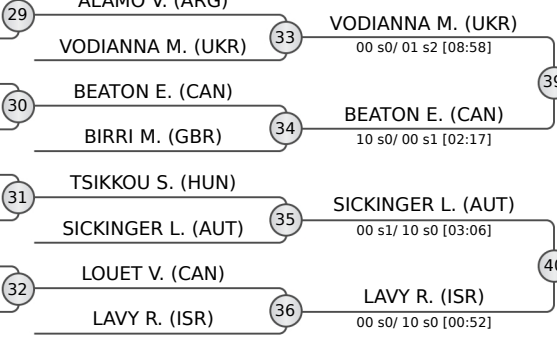

FINAL RESULTS		
1.	BERES Lea	FRA
2.	MAMIRA Luca	HUN
3.	VEG Luca	HUN
3.	VODIANNA Melaniia	UKR
5.	LAVY Ruth	ISR
7.	JENMAN Charlotte	GBR
7.	BEATON Evelyn	CAN
7.	SICKINGER Larissa	AUT



# Paks Junior European Cup 2023

Hungary, Paks, 8-9 Jul 2023

## -57 kg

Juniors (17)

POOL A

	DEVERSAIN Chloe	FRA
	MAIDANA Juana	ARG
	SZASZ Hanna	HUN
	SAAD Emma	ISR

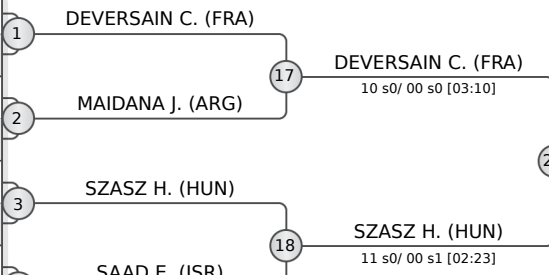

POOL B

	ZIANE Wissal	MAR
	BERLIK Dorottya	HUN
	SAVOIE Mahee	CAN
	AMANN Fanny	AUT
	HAYUN Ilay	ISR

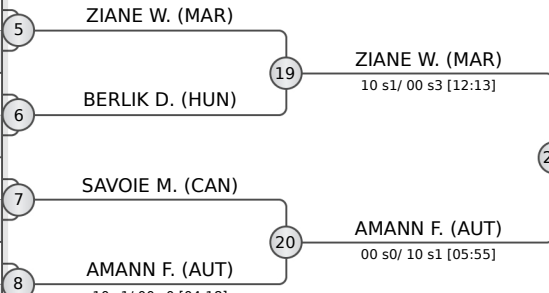

POOL C

	ZAGURI Daniella	ISR
	BOGNAR Inez	HUN
	TOSHKOV Catherine	CAN
	DE CARVALHO Alya	FRA

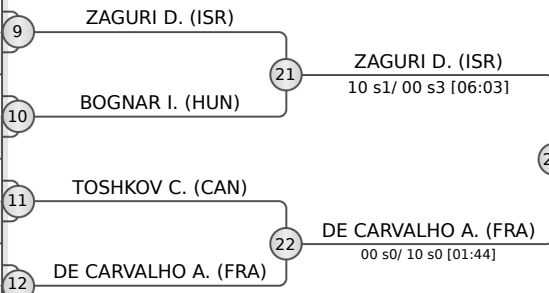

POOL D

	SHYMKARENKO Inna	UKR
	DRABIK Zsofia	HUN
	BORDINSKYKH Sofia	UKR
	LIPPERT Sarah	AUT

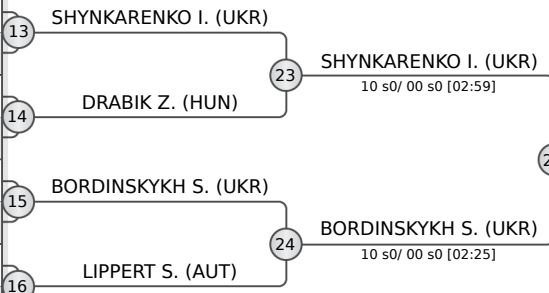

REPECHAGE

SAAD E. (ISR)	29	SAAD E. (ISR)	33	DEVERSAIN C. (FRA)
BERLIK D. (HUN)	30	BERLIK D. (HUN)	34	AMANN F. (AUT)
TOSHKOV C. (CAN)	31	TOSHKOV C. (CAN)	35	TOSHKOV C. (CAN)
DRABIK Z. (HUN)	32	DRABIK Z. (HUN)	36	BORDINSKYKH S. (UKR)

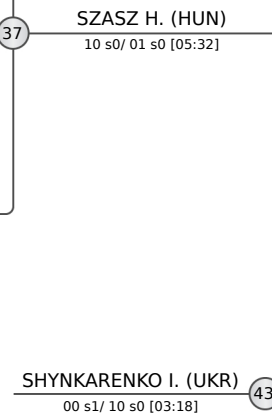
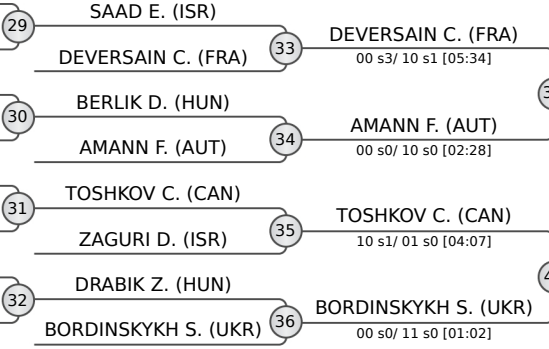

FINAL RESULTS		
1.	SHYMKARENKO Inna	UKR
2.	SZASZ Hanna	HUN
3.	BORDINSKYKH Sofia	UKR
3.	DE CARVALHO Alya	FRA
5.	ZIANE Wissal	MAR
7.	AMANN Fanny	AUT
7.	TOSHKOV Catherine	CAN



# Paks Junior European Cup 2023

Hungary, Paks, 8-9 Jul 2023

## -63 kg

Juniors (28)

POOL A

	AUCHECORNE Melkia	FRA
	SHMUEL Lior	ISR
	PETER Fruzsina	HUN
	SCHLOEGL Franziska	AUT
	KELEMEN Adel	HUN
	CARROUTH Karlee	USA
	KRAVCHUK Valeriia	UKR

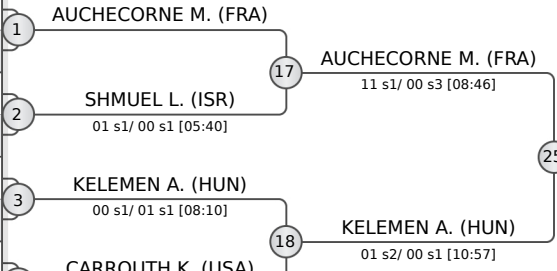

POOL B

	KRIZA Anna	HUN
	KITCHEN Isobel	GBR
	BEREHOVA Bohdana	UKR
	SIMIC Nina	CRO
	SLIMANI Dounia	MAR
	PERKINSON Meloize	CAN
	KARASTRATIDOU Eleni	GRE

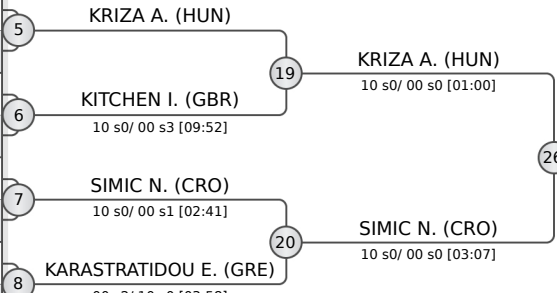

POOL C

	PRIMO Kerem	ISR
	BADURA Daniela	POL
	MILLS Katie	GBR
	RAMETTA Ryley	AUS
	LAJOS Orsolya	ROU
	TRETNJAK Lisa	AUT
	KRUPL Georgina	HUN

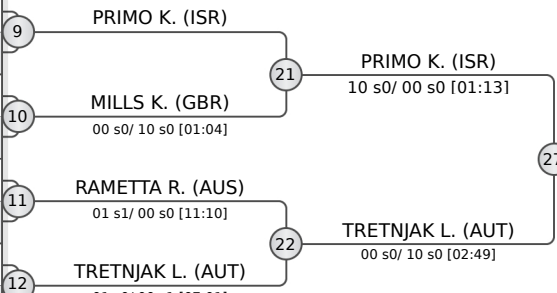

POOL D

	COHEN UDI Yuval	ISR
	STARZER Emily	AUT
	VIT Lili	HUN
	FALGON Julie	FRA
	DRIH Olha	UKR
	ROBERTSON Loika	CAN
	HANSEN Karoline	DEN

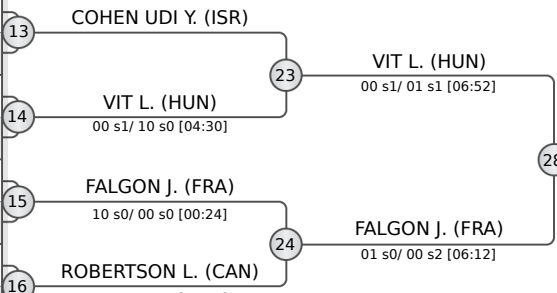

REPECHAGE

29	SHMUEL L. (ISR)	33	KELEMEN A. (HUN)
30	KITCHEN I. (GBR)	34	SIMIC N. (CRO)
31	MILLS K. (GBR)	35	TRETNJAK L. (AUT)
32	ROBERTSON L. (CAN)	36	VIT L. (HUN)

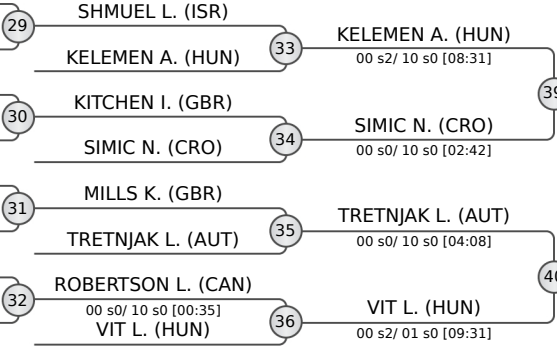

AUCHECORNE M. (FRA) 43  
10 s0/ 00 s1 [06:38]

FALGON J. (FRA) 38  
00 s2/ 11 s1 [07:49]

FINAL RESULTS	
1.	AUCHECORNE Melkia FRA
2.	FALGON Julie FRA
3.	PRIMO Kerem ISR
5.	KRIZA Anna HUN
5.	KELEMEN Adel HUN
7.	VIT Lili HUN
7.	SIMIC Nina CRO
7.	TRETNJAK Lisa AUT





# Paks Junior European Cup 2023

Hungary, Paks, 8-9 Jul 2023

## -70 kg

Juniors (18)

POOL A

	RASOANAIVO RAZAFY Aina Laura	MAD
	VIDENEIEVA Alisa	UKR
	WOOD Nicole	GBR
	BAR OR Gaya	ISR
	DESANGLE Marie	FRA

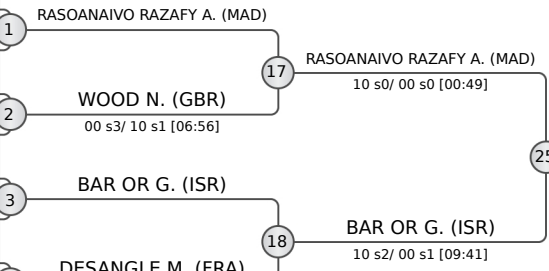

POOL B

	MALKA Avia	ISR
	LLOYD Gwen	GBR
	BIRON Laurence	CAN
	SOCZO Rebeka	HUN

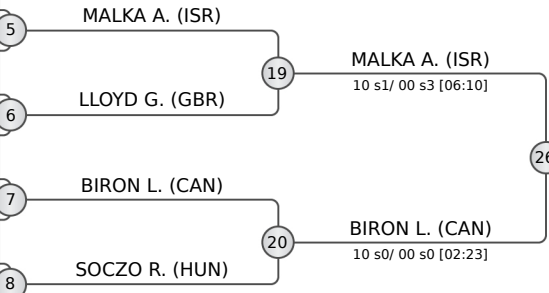

POOL C

	KULIC Karla	CRO
	NIETO Joaquina	ARG
	RYTSKA Mariia	UKR
	PAPAGIANNAKI Alexandra	GRE

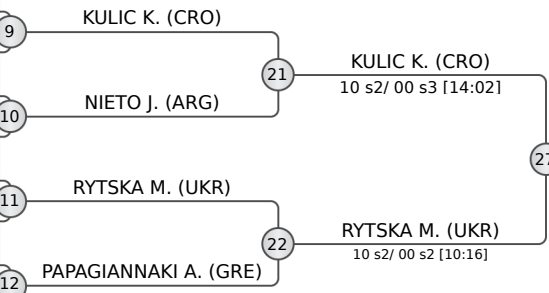

POOL D

	MAZZARINO Lila	FRA
	BARON Wiktoria	POL
	MIDDLETON Saya	AUS
	GILBERT Ellie	GBR
	PIRITI Rebeka	HUN

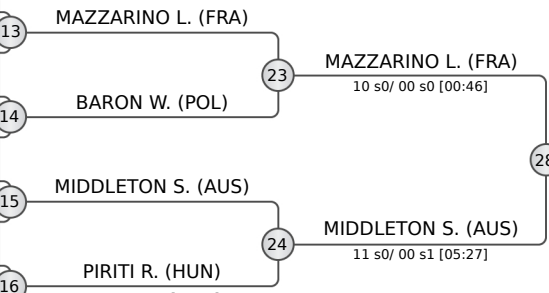

REPECHAGE

29	DESANGLE M. (FRA)
30	SOCZO R. (HUN)
31	NIETO J. (ARG)
32	BARON W. (POL)

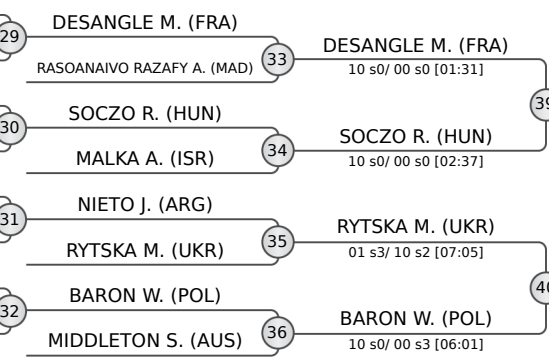

FINAL RESULTS	
1.	KULIC Karla CRO
2.	BAR OR Gaya ISR
3.	DESANGLE Marie FRA
3.	RYTSKA Mariia UKR
5.	MAZZARINO Lila FRA
5.	BIRON Laurence CAN
7.	SOCZO Rebeka HUN
7.	BARON Wiktoria POL



# Paks Junior European Cup 2023

Hungary, Paks, 8-9 Jul 2023

**-78 kg**  
Juniors (13)

**POOL A**

	RUBIANO Morgane	FRA
	VULPASIN Maria-Nicoleta	GRE
	WILSON Gracie	GBR

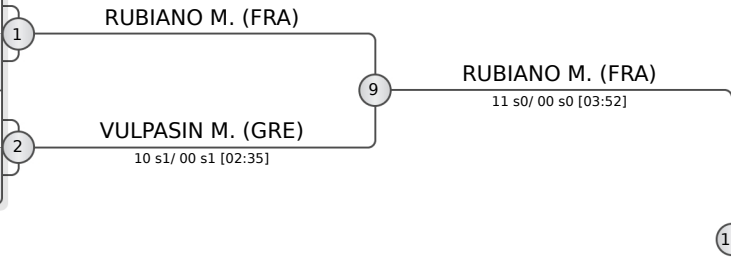

**POOL B**

	JAKUS Nika	CRO
	CSISZAR Csenge	HUN
	SUMMER Laura	AUT
	EL HOUMATE Jihane	MAR

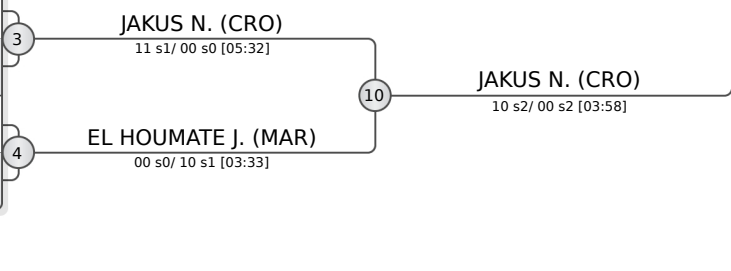

**POOL C**

	SAGI Nikolett	HUN
	HASSAN Anya	GBR
	SOKCEVIC Christina	AUT

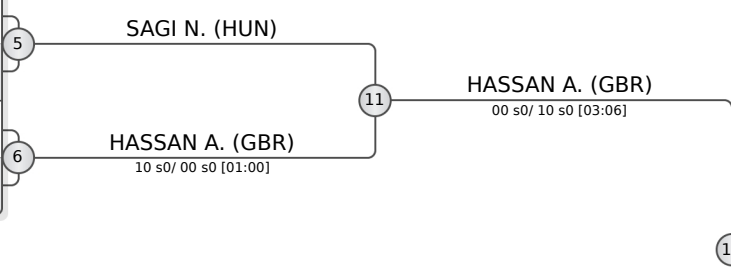

**POOL D**

	BOUVIER Ilana	FRA
	STJEPANOVIC Jovana	SRB
	GREGORY Cordelia	GBR

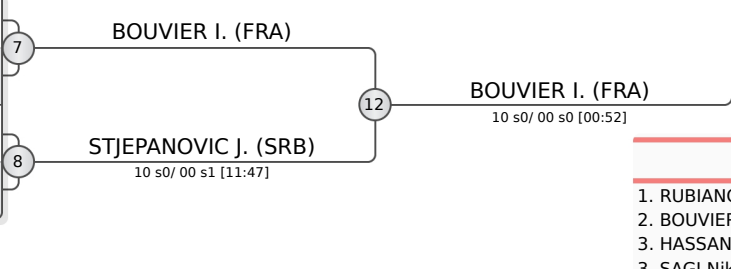

FINAL RESULTS		
1.	RUBIANO Morgane	FRA
2.	BOUVIER Ilana	FRA
3.	HASSAN Anya	GBR
5.	SAGI Nikolett	HUN
5.	EL HOUMATE Jihane	MAR
5.	JAKUS Nika	CRO
7.	VULPASIN Maria-Nicoleta	GRE
7.	STJEPANOVIC Jovana	SRB

**REPECHAGE**

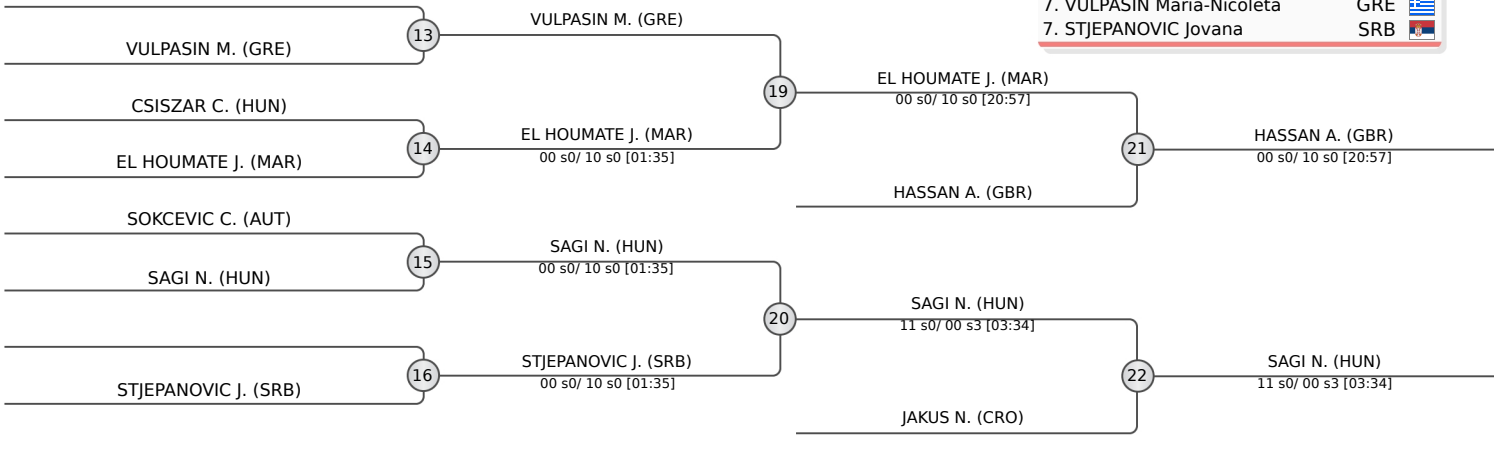



# Paks Junior European Cup 2023

Hungary, Paks, 8-9 Jul 2023

## +78 kg

Juniors (7)

POOL A

	MISHINER Yuli Alma	ISR
	DANI Dorottya	HUN

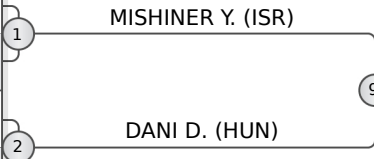

MISHINER Y. (ISR)

10 s0/ 00 s0 [00:42]

POOL B

	MILER Georgiana	ROU
	MCRAE Harriet	GBR

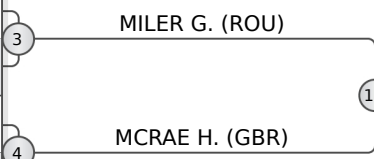

MILER G. (ROU)

10 s0/ 00 s0 [00:57]

POOL C

	DIARRASSOUBA Oceane	FRA

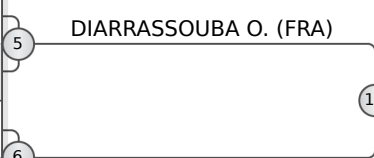

DIARRASSOUBA O. (FRA)

POOL D

	BIELKOVA Marharyta	UKR
	HUSZAR Regina	HUN

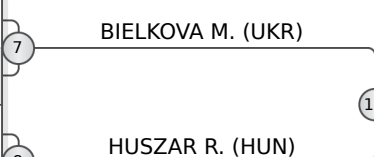

BIELKOVA M. (UKR)

10 s2/ 00 s1 [03:54]

REPECHAGE

	DANI D. (HUN)	13
	MCRAE H. (GBR)	14
		15
	HUSZAR R. (HUN)	16

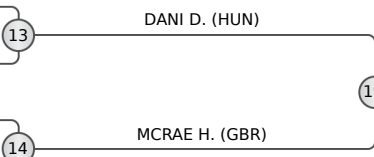

DANI D. (HUN)

00 s0/ 11 s0 [01:36]

BIELKOVA M. (UKR)

00 s0/ 11 s0 [01:36]

HUSZAR R. (HUN)

00 s0/ 10 s0 [01:10]

MISHINER Y. (ISR)

00 s0/ 10 s0 [01:10]

MILER G. (ROU)

00 s1/ 10 s2 [05:08]

MILER G. (ROU)

10 s0/ 01 s0 [03:46]

DIARRASSOUBA O. (FRA)

10 s0/ 00 s0 [01:15]

FINAL RESULTS		
1.	MILER Georgiana	ROU
2.	DIARRASSOUBA Oceane	FRA
3.	MISHINER Yuli Alma	ISR
3.	BIELKOVA Marharyta	UKR
5.	HUSZAR Regina	HUN
5.	DANI Dorottya	HUN
7.	MCRAE Harriet	GBR