



Panamerican and Oceania Championships Juniors Individuals 2024

Brazil, Rio de Janeiro, 23 Apr 2024

-60 kg

Juniors (19)

POOL A

	VELAZCO Christopher	USA
	MALDONADO Esteban	ARG
	PINO BALBIN Jeronimo	COL
	SOLIS FERNANDEZ Ivan	CRC
	OSSES Agustin	CHI

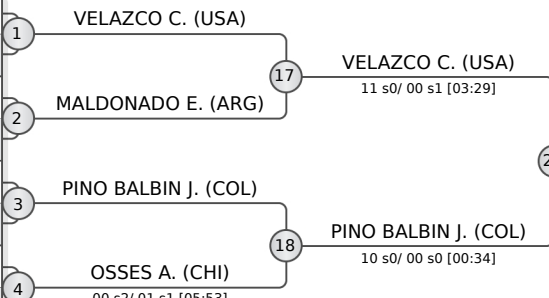

POOL B

	CASTRO Dany Manuel	DOM
	HERNANDEZ MACIAS Carlos Maximiliano	MEX
	NEPTON Vincent	CAN
	ARANDA RODRIGUEZ Iker	PAR
	MATSUMOTO KANEDA Erick	BRA

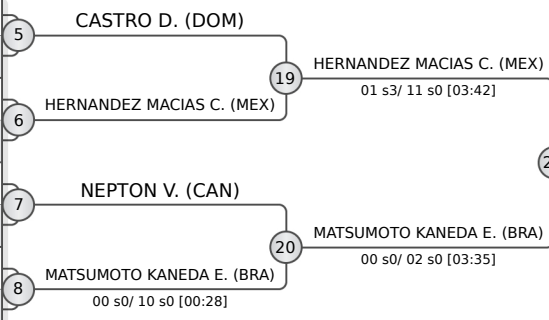

POOL C

	CABRAL Mateo	PAR
	BENAVIDES Jhonathan	ECU
	VILLAVICENCIO Galo	ARG
	CANO S Alejandro	CRC

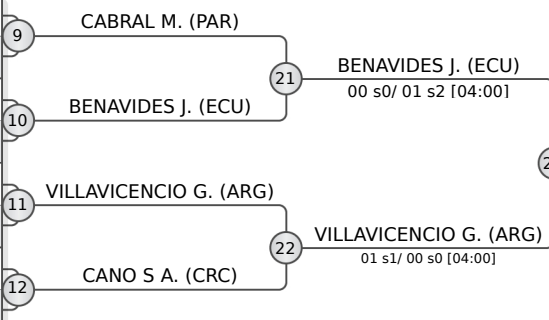

POOL D

	SAGASTEGUI Eduardo	MEX
	LEON Andres	VEN
	YANG Jonathan	USA
	SIMO GARCIA Manuel Eduardo	DOM
	DESSUREAULT Victor	CAN

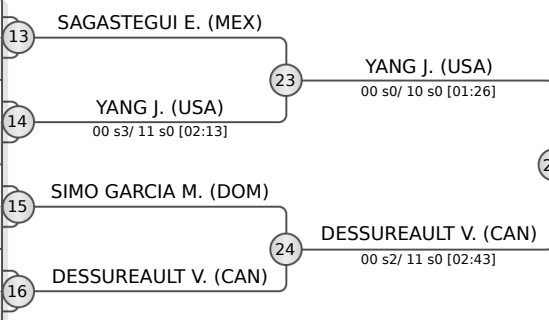

FINAL RESULTS		
1.	VELAZCO Christopher	USA
2.	BENAVIDES Jhonathan	ECU
3.	PINO BALBIN Jeronimo	COL
3.	YANG Jonathan	USA
5.	DESSUREAULT Victor	CAN
5.	HERNANDEZ MACIAS Carlos Maximiliano	MEX
7.	MATSUMOTO KANEDA Erick	BRA
7.	VILLAVICENCIO Galo	ARG

REPECHAGE

29	MALDONADO E. (ARG)	33	PINO BALBIN J. (COL)
30	CASTRO D. (DOM)	34	MATSUMOTO KANEDA E. (BRA)
31	CABRAL M. (PAR)	35	VILLAVICENCIO G. (ARG)
32	SIMO GARCIA M. (DOM)	36	YANG J. (USA)

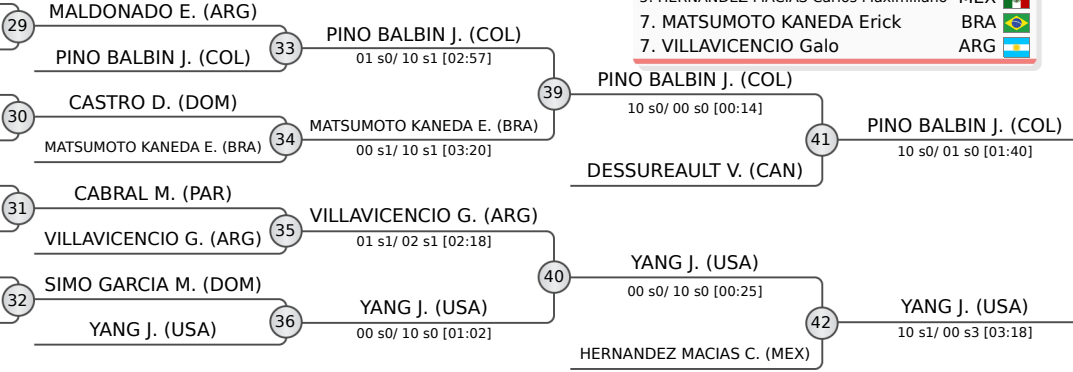



Panamerican and Oceania Championships Juniors Individuals 2024

Brazil, Rio de Janeiro, 23 Apr 2024

-66 kg
Juniors (21)

POOL A

	ICELO Jose	MEX
	JOHNSON Xavion	BAH
	LEDESMA Agustin	PAR
	MEYER Fabricio	CHI
	VIDAL Tobias	ARG

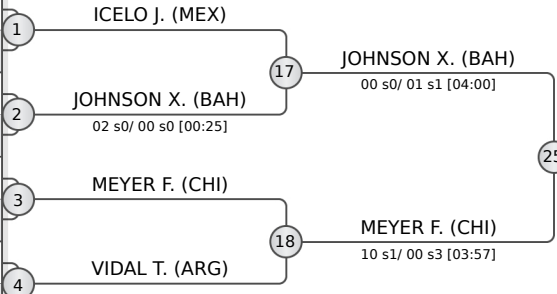

POOL B

	BALTAZAR Franco	PER
	VILLADA Santiago	COL
	KREMERMAN Daniil	CAN
	RIOS Danny	VEN
	VALDIVIESO Alfredo	ECU

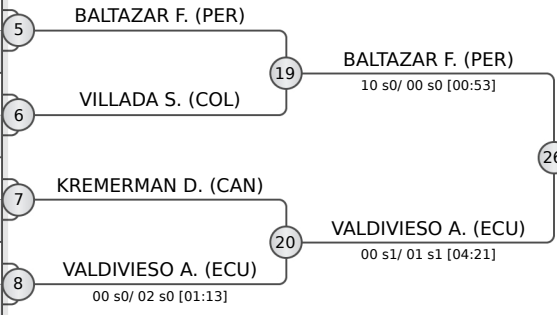

POOL C

	CACERES Reinaldo	CHI
	CONDOR Mateo	PER
	LIORI RODRIGUEZ Luciano Valentino	URU
	ALVARENGA SOTO Reiver	ARG
	SANTOS DE OLIVEIRA Iago	BRA
	LE BRIS Lowan	CAN

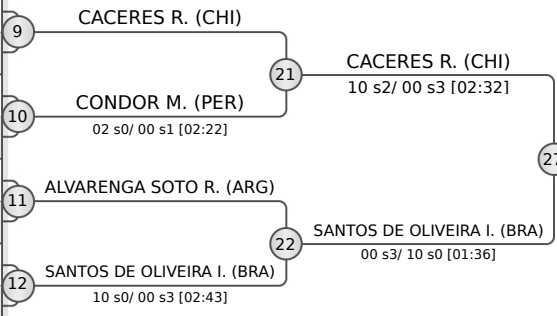

POOL D

	AYALA Kevin	ECU
	YANG Jacob	USA
	SANCHEZ GARNICA Keiner	COL
	AGUIRRE RAMIREZ Ian Kenner	MEX
	BOLANOS VEGA Pablo	CRC

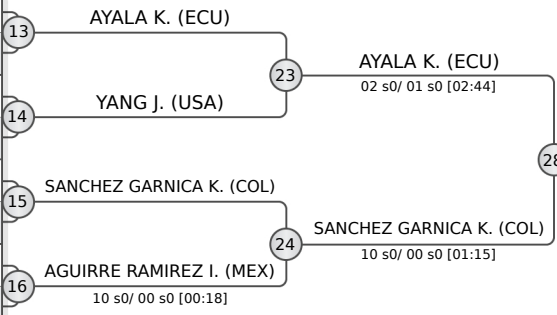

REPECHAGE

LEDESMA A. (PAR)	ICELO J. (MEX)	MEYER F. (CHI)
ICELO J. (MEX)	RIOS D. (VEN)	MEYER F. (CHI)
RIOS D. (VEN)	KREMERMAN D. (CAN)	BALTAZAR F. (PER)
KREMERMAN D. (CAN)	LE BRIS L. (CAN)	BALTAZAR F. (PER)
LE BRIS L. (CAN)	ALVARENGA SOTO R. (ARG)	LE BRIS L. (CAN)
ALVARENGA SOTO R. (ARG)	YANG J. (USA)	LE BRIS L. (CAN)
YANG J. (USA)	YANG J. (USA)	YANG J. (USA)
YANG J. (USA)	SANCHEZ GARNICA K. (COL)	YANG J. (USA)

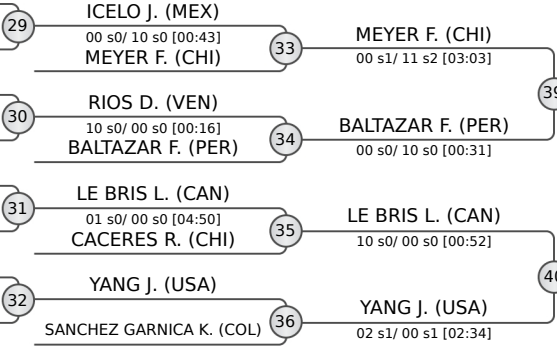

SANTOS DE OLIVEIRA I. (BRA) (43) [00 s3/ 10 s0 [03:16]]

SANTOS DE OLIVEIRA I. (BRA) (38) [02 s1/ 00 s1 [03:09]]

FINAL RESULTS		
1.	SANTOS DE OLIVEIRA Iago	BRA
2.	VALDIVIESO Alfredo	ECU
3.	AYALA Kevin	ECU
3.	YANG Jacob	USA
5.	MEYER Fabricio	CHI
7.	JOHNSON Xavion	BAH
7.	BALTAZAR Franco	PER
7.	LE BRIS Lowan	CAN





Panamerican and Oceania Championships Juniors Individuals 2024

Brazil, Rio de Janeiro, 23 Apr 2024

-73 kg
Juniors (13)

POOL A

	TSATSALASHVILI Lasha	CAN
	BOLDBAATAR Steven	USA
	ELISII Franco	ARG

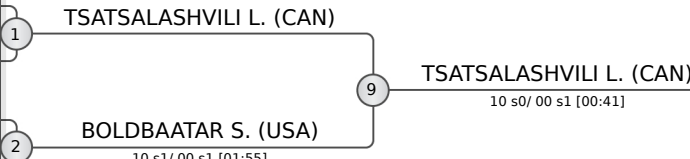

POOL B

	GONZALEZ Jose	ECU
	GUZMAN Yohel	CRC
	DE OLIVEIRA Guilherme	BRA
	FLORES MARTINEZ Dante De Jesus	MEX

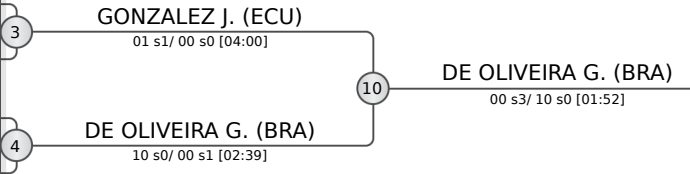

POOL C

	HERNANDEZ Tomas	CHI
	GUERRA Ricardo	MEX
	SILVA MANZI Paolo Alberto	URU

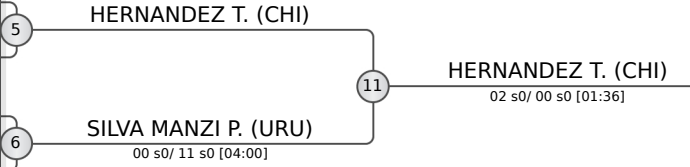

POOL D

	LOUIS PIERRE Maikor Yefri	DOM
	BARRIONUEVO Esteban	ARG
	SALAS Brandon	CRC

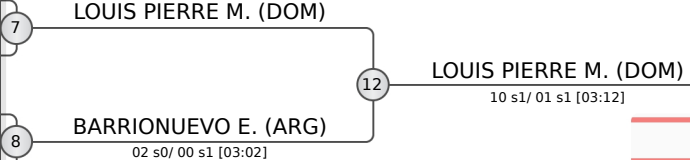

REPECHAGE

13	BOLDBAATAR S. (USA)
14	GONZALEZ J. (ECU)
15	SILVA MANZI P. (URU)
16	BARRIONUEVO E. (ARG)

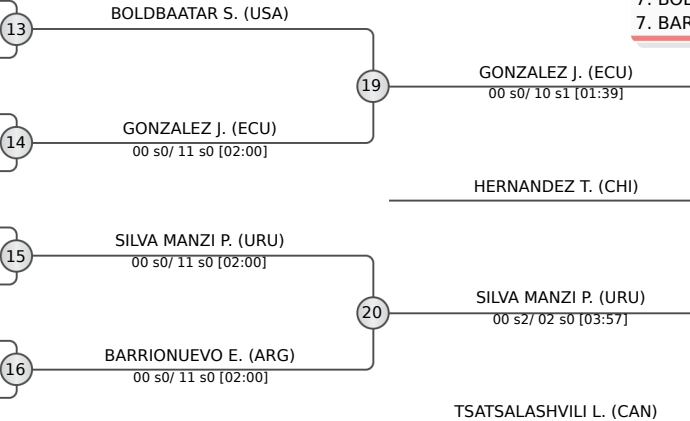

FINAL RESULTS		
1.	DE OLIVEIRA Guilherme	BRA
2.	LOUIS PIERRE Maikor Yefri	DO
3.	HERNANDEZ Tomas	CHI
3.	TSATSALASHVILI Lasha	CAN
5.	GONZALEZ Jose	ECU
5.	SILVA MANZI Paolo Alberto	URU
7.	BOLDBAATAR Steven	USA
7.	BARRIONUEVO Esteban	ARG





POOL A

	PARICHE Luis	VEN
	KARPUKOV Arthur	CAN
	SIMOMURA MAXILIANO TROMBINI Enzo	BRA

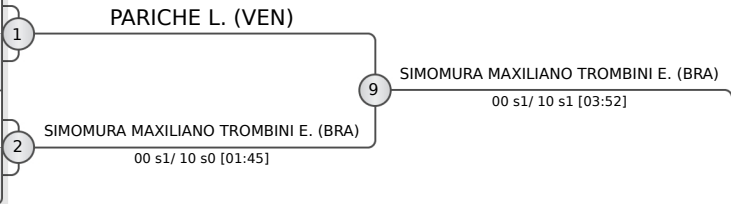

POOL B

	PEREZ RUIZ John	COL
	GOMEZ Demis	CHI

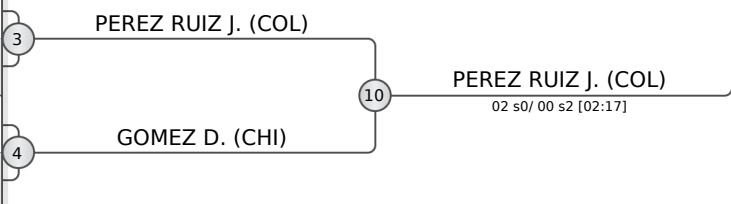

POOL C

	RODRIGUEZ Dominic	USA
	MARTINEZ SANCHEZ Alejandro	MEX

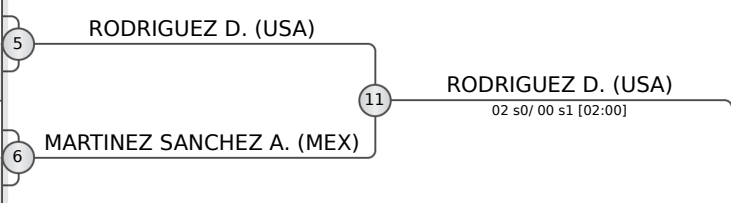

POOL D

	KRYVYTSKYI Tigran	CAN
	ALMEIDA Luan	BRA

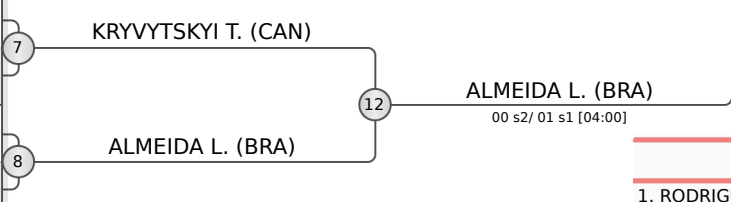

FINAL RESULTS		
1.	RODRIGUEZ Dominic	USA
2.	SIMOMURA MAXILIANO TROMBINI Enzo	BRA
3.	ALMEIDA Luan	BRA
3.	PEREZ RUIZ John	COL
5.	PARICHE Luis	VEN
7.	KRYVYTSKYI Tigran	CAN
7.	GOMEZ Demis	CHI
7.	MARTINEZ SANCHEZ Alejandro	MEX

REPECHAGE

KARPUKOV A. (CAN)	PARICHE L. (VEN)
PARICHE L. (VEN)	GOMEZ D. (CHI)
GOMEZ D. (CHI)	MARTINEZ SANCHEZ A. (MEX)
MARTINEZ SANCHEZ A. (MEX)	KRYVYTSKYI T. (CAN)
KRYVYTSKYI T. (CAN)	

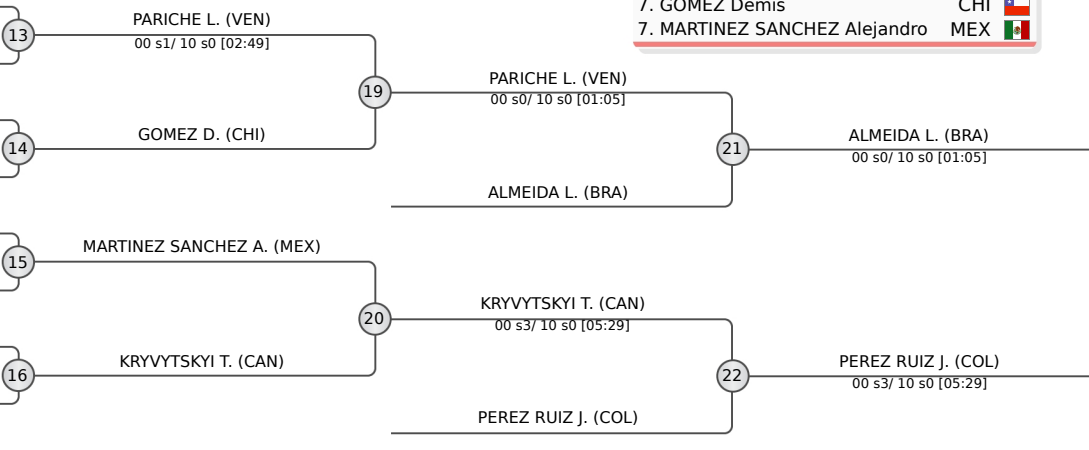



Panamerican and Oceania Championships Juniors Individuals 2024

Brazil, Rio de Janeiro, 23 Apr 2024

-90 kg
Juniors (10)

POOL A

	MILANO Gustavo	BRA
	CORZO Samuel	VEN
	GUERRERO VARGAS Lucas	COL

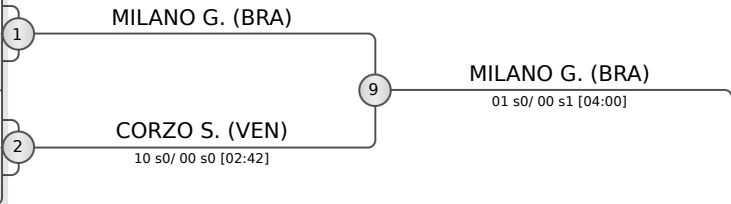

POOL B

	BARBOSA Jesse	BRA
	NYZHNYK Oleksandr	USA

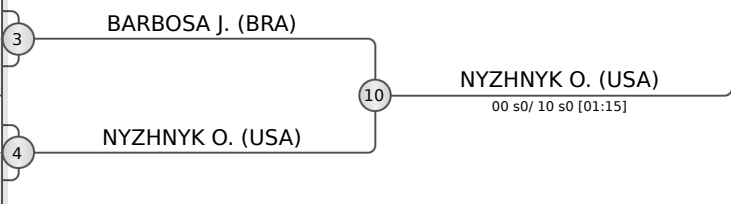

POOL C

	RODRIGUEZ Derik	PUR
	QUINTEROS Tomas	ARG

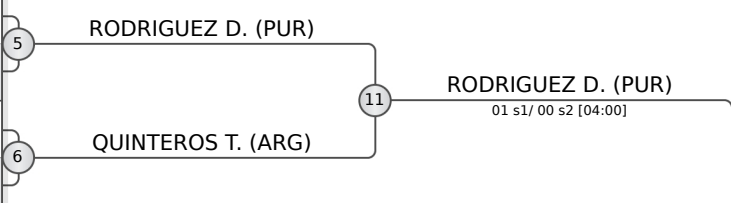

POOL D

	PALADII Yehor	CAN
	BENITEZ Edgar	PAR
	CAICEDO SINISTERRA Jhon	COL

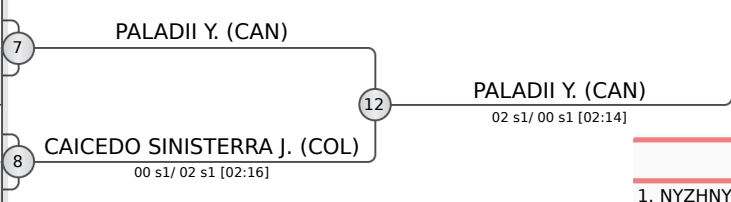

REPECHAGE

CORZO S. (VEN)	13	CORZO S. (VEN)
BARBOSA J. (BRA)	14	BARBOSA J. (BRA)
QUINTEROS T. (ARG)	15	QUINTEROS T. (ARG)
CAICEDO SINISTERRA J. (COL)	16	CAICEDO SINISTERRA J. (COL)

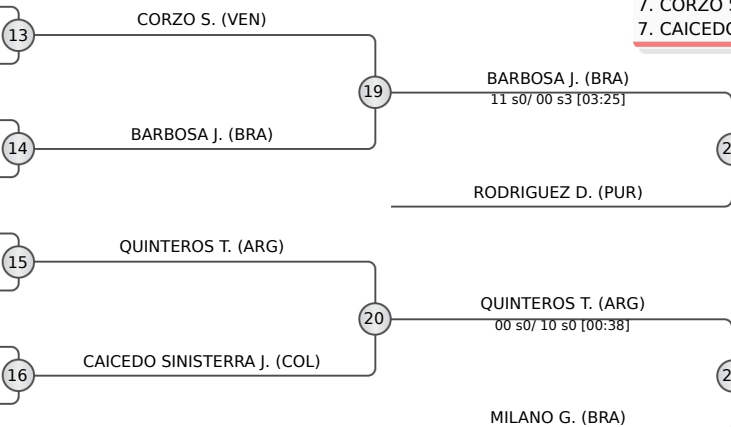

FINAL RESULTS		
1.	NYZHNYK Oleksandr	USA
2.	PALADII Yehor	CAN
3.	BARBOSA Jesse	BRA
3.	MILANO Gustavo	BRA
5.	RODRIGUEZ Derik	PUR
5.	QUINTEROS Tomas	ARG
7.	CORZO Samuel	VEN
7.	CAICEDO SINISTERRA Jhon	COL





Num.	Competitor	State	1	3	5	Wins	Points
1.	VALDIVIA Valentino	Peru		0	0	0	0
3.	LIUBIMOVSKI Daniel	United States of America	10		10	2	20
5.	ZUCKER Zalman	United States of America	10	0		1	10

Num.	Competitor	State	2	4	Wins	Points
2.	KRAMER Andre	Brazil		10	0	0
4.	FRANCO Eduardo	Venezuela	0		1	0

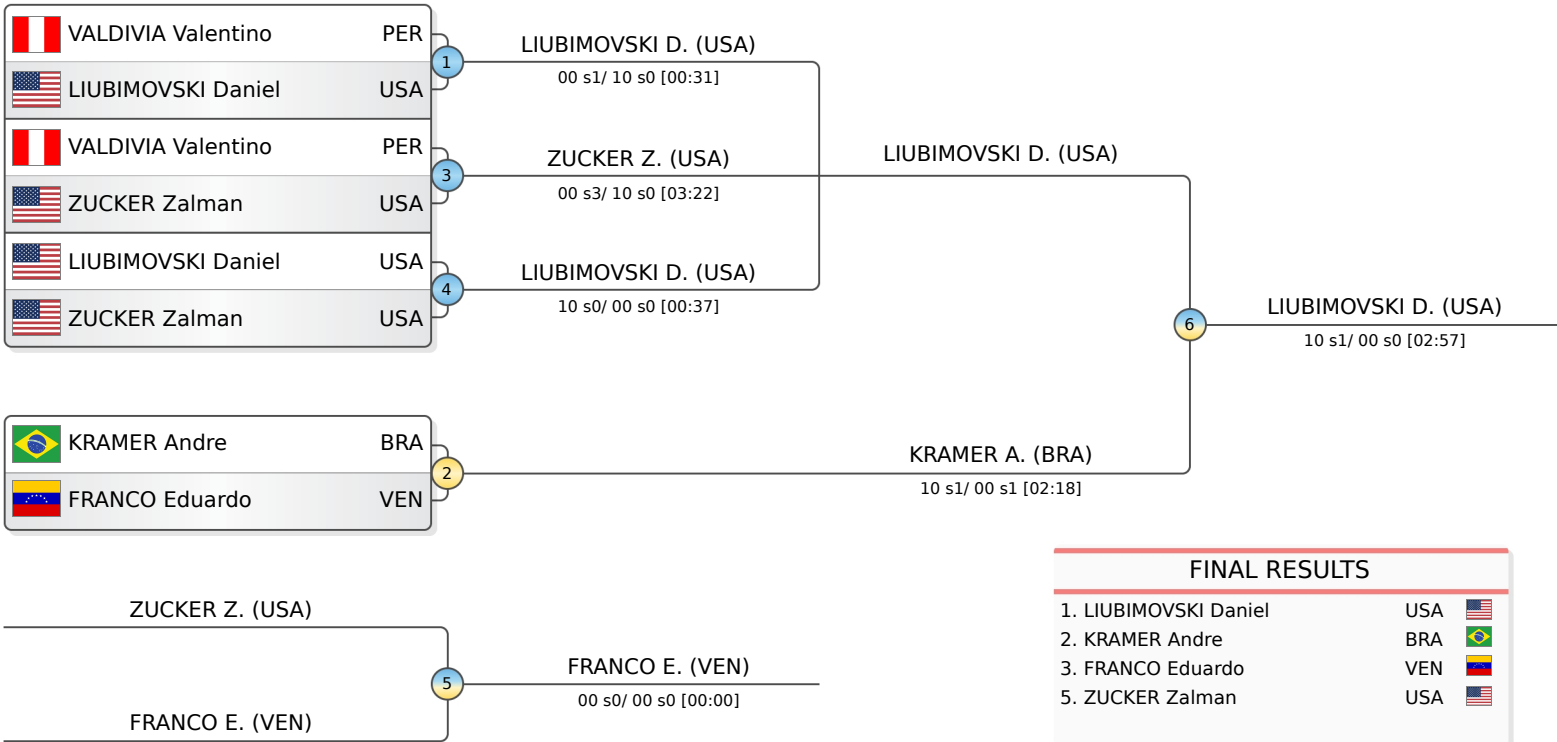



POOL A

MESSE A BESSONG John Jr CAN
 DIAS DUARTE Breno BRA

1 MESSE A BESSONG J. (CAN)

10 s0/ 00 s0 [00:20]

POOL B

URRA Patricio CHI
 SANCHEZ Hugo MEX

2 URRA P. (CHI)

10 s2/ 00 s3 [05:10]

POOL C

BRACHE JARQUIN Jose Miguel DOM
 AKOJYAN Armen USA

3 BRACHE JARQUIN J. (DOM)

02 s0/ 00 s1 [02:11]

POOL D

CASTELAN Gerardo MEX
 CANIZALEZ Gustavo VEN

4 CANIZALEZ G. (VEN)

00 s0/ 11 s0 [01:04]

5 MESSE A BESSONG J. (CAN)

10 s0/ 00 s0 [00:49]

6 BRACHE JARQUIN J. (DOM)

02 s0/ 00 s0 [03:05]

11 MESSE A BESSONG J. (CAN)

02 s0/ 00 s0 [01:16]

FINAL RESULTS

- 1. MESSE A BESSONG John Jr CAN
- 2. BRACHE JARQUIN Jose Miguel DO
- 3. DIAS DUARTE Breno BRA
- 3. URRA Patricio CHI
- 5. CANIZALEZ Gustavo VEN
- 5. CASTELAN Gerardo MEX

REPECHAGE

DIAS DUARTE B. (BRA)

SANCHEZ H. (MEX)

AKOJYAN A. (USA)

CASTELAN G. (MEX)

7 DIAS DUARTE B. (BRA)

10 s0/ 00 s3 [00:55]

CANIZALEZ G. (VEN)

8 CASTELAN G. (MEX)

00 s0/ 02 s1 [01:55]

URRA P. (CHI)

9 DIAS DUARTE B. (BRA)

10 s0/ 00 s1 [00:48]

10 URRA P. (CHI)

10 s0/ 00 s1 [00:48]





Panamerican and Oceania Championships Juniors Individuals 2024

Brazil, Rio de Janeiro, 23 Apr 2024

-48 kg
Juniors (16)

POOL A

	URENA Maryury	COL
	GIMENEZ Nancy	PAR
	RIBEIRO Clarice	BRA
	TOLOZA Ayinko	CHI

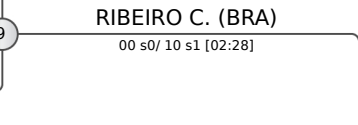
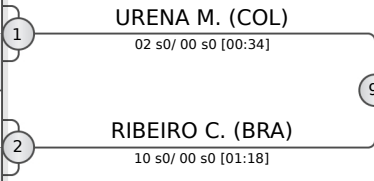

POOL B

	TURMEL Marie-Lune	CAN
	CHINCHILLA CALVO Ashley	CRC
	BURZIO Nayla	ARG
	PINO Natalie	USA

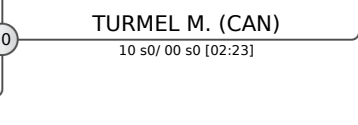
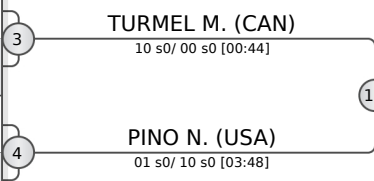

POOL C

	QUACH Heidi	CAN
	SILVA ANDRADE Mariana Yadeli	MEX
	NUNES Mariana	BRA
	DIAZ Martina	CHI

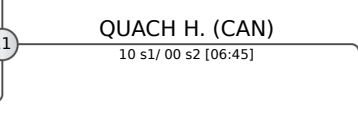
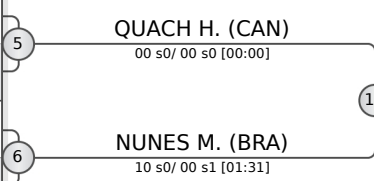

POOL D

	JARA Erika	ECU
	POPOFF Ambre	PYF
	CRESPO Manuela	COL
	PEREZ Victoria	ARG

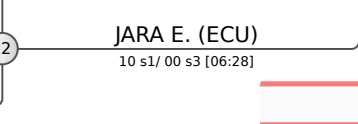
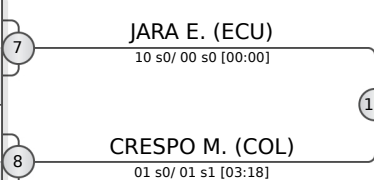

FINAL RESULTS		
1.	RIBEIRO Clarice	BRA
2.	JARA Erika	ECU
3.	QUACH Heidi	CAN
3.	TURMEL Marie-Lune	CAN
5.	URENA Maryury	COL
5.	NUNES Mariana	BRA
7.	PINO Natalie	USA
7.	CRESPO Manuela	COL

REPECHAGE

TOLOZA A. (CHI)	13	URENA M. (COL)
URENA M. (COL)	14	PINO N. (USA)
CHINCHILLA CALVO A. (CRC)	15	NUNES M. (BRA)
PINO N. (USA)	16	CRESPO M. (COL)
SILVA ANDRADE M. (MEX)		
NUNES M. (BRA)		
POPOFF A. (PYF)		
CRESPO M. (COL)		

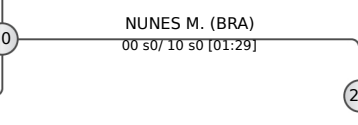
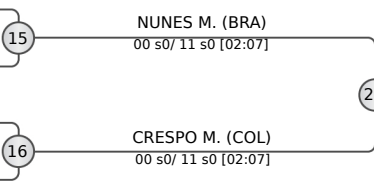
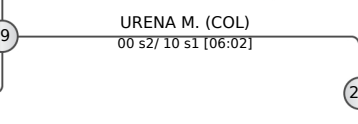
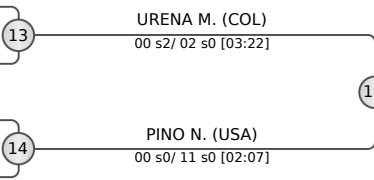



Panamerican and Oceania Championships Juniors Individuals 2024

Brazil, Rio de Janeiro, 23 Apr 2024

-52 kg
Juniors (15)

POOL A

	GOLU Wendy	COL
	RODRIGUES Rafaela	BRA
	TALAVERA Ashliegh	PAR

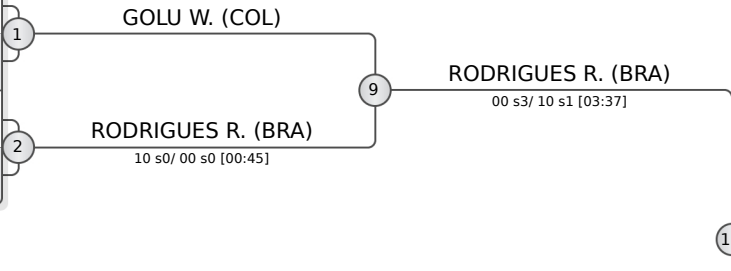

POOL B

	MARTINEZ VIRGEN Abril	MEX
	CHALA Blanca	ECU
	ALAMO Valentina	ARG
	VASQUEZ CALDERON Valeria	CRC

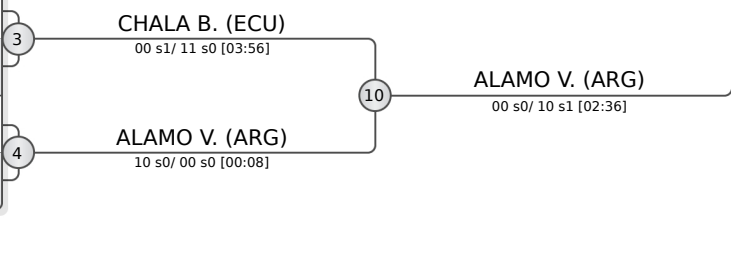

POOL C

	LOPEZ Gabriela	CHI
	SALINAS Stefany	PAR
	RIVAS Driulys	PER
	HILLER Harlee	USA

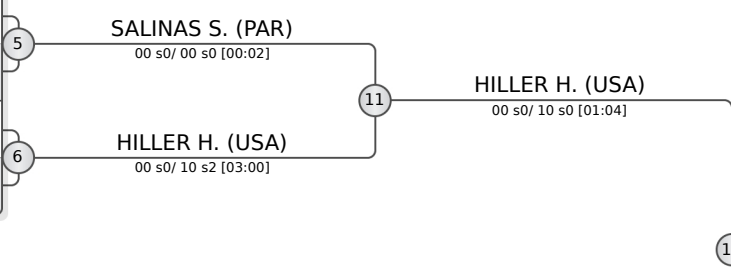

POOL D

	RUIZ Leomaris	VEN
	ANDRADE Nayhdeli	ECU
	AVILA Aylin	MEX
	MORALES GAMBOA Jimena	CRC

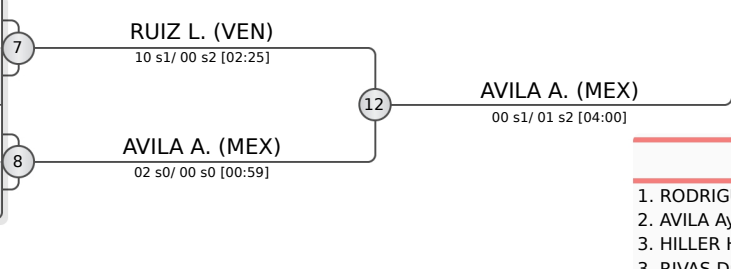

FINAL RESULTS		
1.	RODRIGUES Rafaela	BRA
2.	AVILA Aylin	MEX
3.	HILLER Harlee	USA
3.	RIVAS Driulys	PER
5.	GOLU Wendy	COL
5.	ALAMO Valentina	ARG
7.	CHALA Blanca	ECU
7.	RUIZ Leomaris	VEN

REPECHAGE

TALAVERA A. (PAR)	13	GOLU W. (COL)	19	HILLER H. (USA)	21
GOLU W. (COL)	13	CHALA B. (ECU)	19	HILLER H. (USA)	21
VASQUEZ CALDERON V. (CRC)	14	CHALA B. (ECU)	19	HILLER H. (USA)	21
CHALA B. (ECU)	14	RIVAS D. (PER)	20	RIVAS D. (PER)	22
RIVAS D. (PER)	15	RIVAS D. (PER)	20	RIVAS D. (PER)	22
SALINAS S. (PAR)	15	RUIZ L. (VEN)	20	RIVAS D. (PER)	22
MORALES GAMBOA J. (CRC)	16	RUIZ L. (VEN)	20	RIVAS D. (PER)	22
RUIZ L. (VEN)	16	ALAMO V. (ARG)	22	RIVAS D. (PER)	22

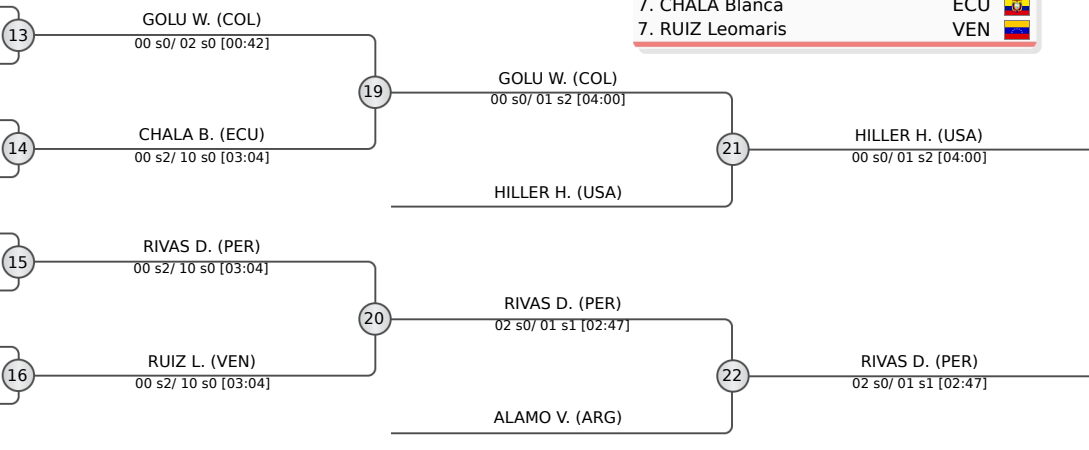



Panamerican and Oceania Championships Juniors Individuals 2024

Brazil, Rio de Janeiro, 23 Apr 2024

-57 kg
Juniors (14)

POOL A

	CANCELA Nicole	USA
	MAIDANA Juana	ARG
	MAYA Frida	MEX

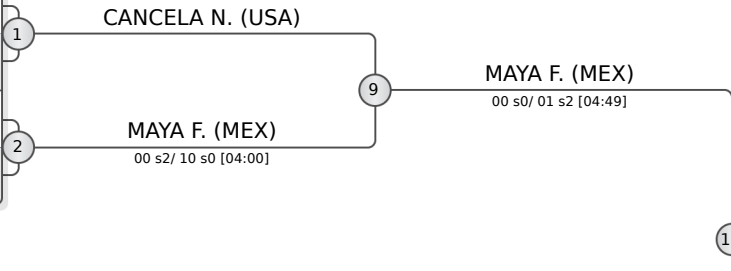

POOL B

	MORENO Martina	CHI
	VAN ZYL Carla	CAN
	ARCE LACAYO Jimena	CRC
	FERRIN Irene	ECU

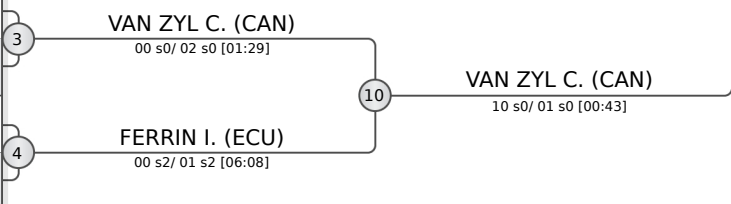

POOL C

	JULCA Luciana	PER
	HENRIQUES Julia	BRA
	MOSQUEDA LOPEZ Montserrat	MEX

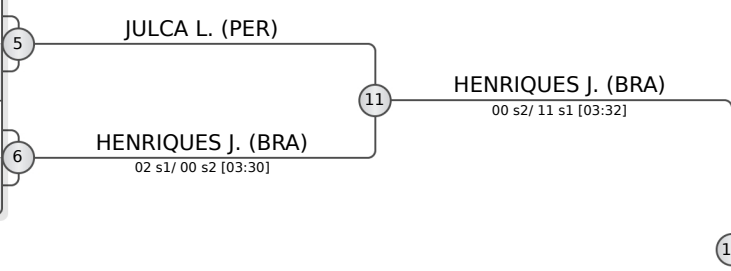

POOL D

	PACHECO Audreys	VEN
	TOSHKOV Catherine	CAN
	VILLANUEVA MOTA Luisa	DOM
	NUNEZ Constanza	ARG

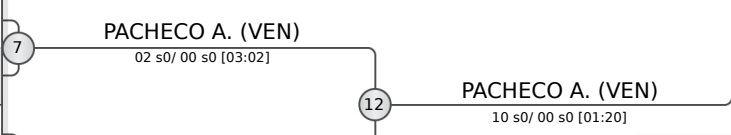

FINAL RESULTS			
1.	HENRIQUES Julia	BRA	
2.	MAYA Frida	MEX	
3.	CANCELA Nicole	USA	
3.	TOSHKOV Catherine	CAN	
5.	PACHECO Audreys	VEN	
5.	VAN ZYL Carla	CAN	
7.	FERRIN Irene	ECU	
7.	MOSQUEDA LOPEZ Montserrat	MEX	

REPECHAGE

MAIDANA J. (ARG)	13	CANCELA N. (USA)	19	CANCELA N. (USA)	21	CANCELA N. (USA)
CANCELA N. (USA)		00 s0/ 10 s0 [01:02]		10 s0/ 00 s3 [02:11]		10 s0/ 00 s3 [02:11]
MORENO M. (CHI)	14	FERRIN I. (ECU)	20	TOSHKOV C. (CAN)	22	TOSHKOV C. (CAN)
FERRIN I. (ECU)		00 s1/ 02 s1 [02:06]		01 s1/ 00 s1 [04:00]		01 s1/ 00 s1 [04:00]
MOSQUEDA LOPEZ M. (MEX)	15	MOSQUEDA LOPEZ M. (MEX)		VAN ZYL C. (CAN)		
JULCA L. (PER)		00 s1/ 02 s1 [02:06]				
TOSHKOV C. (CAN)	16	TOSHKOV C. (CAN)				
NUNEZ C. (ARG)		00 s1/ 02 s1 [02:06]				





Panamerican and Oceania Championships Juniors Individuals 2024

Brazil, Rio de Janeiro, 23 Apr 2024

-63 kg
Juniors (12)

POOL A

	JASPE Emily Daniela	USA
	ROBERTSON Loika	CAN
	CRUZ Maria	MEX

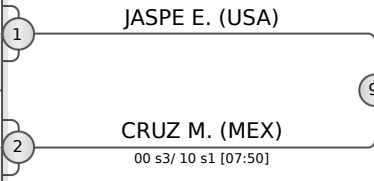

POOL B

	AGUILAR BRAVO Noilyn	CRC
	BUNTON Mackenzie	USA
	DANIN Domenica	ECU

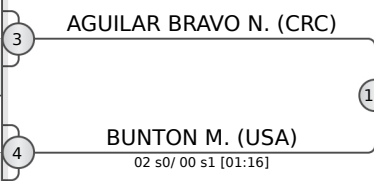

POOL C

	PEREZ Constanza	CHI
	CHEVALIER Margot	CAN
	LAM Hilary	PER

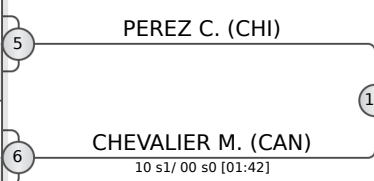

POOL D

	CHOCO Ingrid	COL
	SOTO Javiera	CHI
	FEITOSA Ana Beatriz	BRA

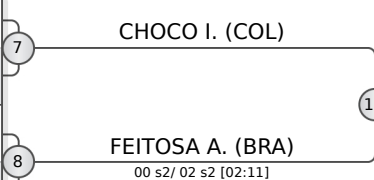

REPECHAGE

13	CRUZ M. (MEX)	19	CRUZ M. (MEX)
14	BUNTON M. (USA)	20	FEITOSA A. (BRA)
15	CHEVALIER M. (CAN)	21	CRUZ M. (MEX)
16	FEITOSA A. (BRA)	22	FEITOSA A. (BRA)

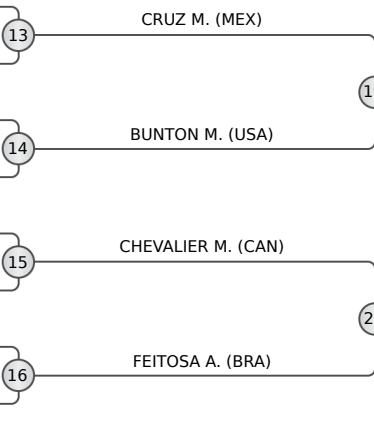

FINAL RESULTS		
1.	JASPE Emily Daniela	USA
2.	CHOCO Ingrid	COL
3.	CRUZ Maria	MEX
3.	FEITOSA Ana Beatriz	BRA
5.	PEREZ Constanza	CHI
5.	AGUILAR BRAVO Noilyn	CRC
7.	BUNTON Mackenzie	USA
7.	CHEVALIER Margot	CAN





Panamerican and Oceania Championships Juniors Individuals 2024

Brazil, Rio de Janeiro, 23 Apr 2024

-70 kg

Juniors (14)

POOL A

	CARDOSO Kaillany	BRA
	SANDOVAL Renata	MEX
	DUARTE Valeria	PAR

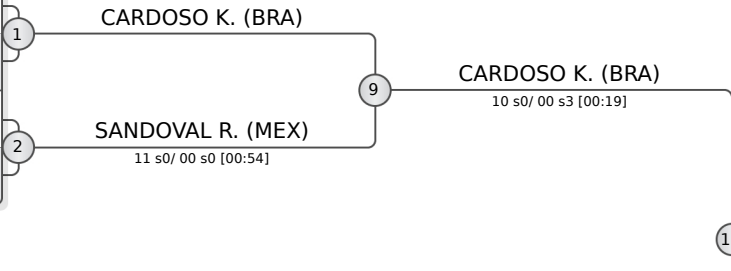

POOL B

	JIMENEZ Valentina	CHI
	ESPINA Hannelys	VEN
	MAYORGA Ignacia	CHI
	FIGUEROA Iara	ARG

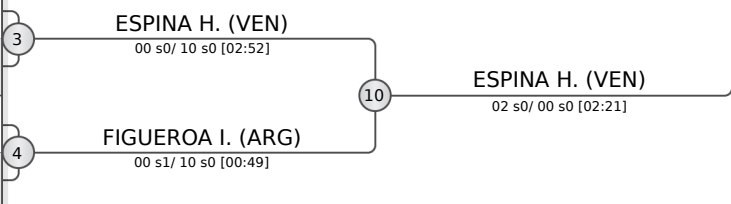

POOL C

	GONZALEZ Shavon	USA
	NIETO Joaquina	ARG
	RAMIREZ PEGUERO Victoria	DOM

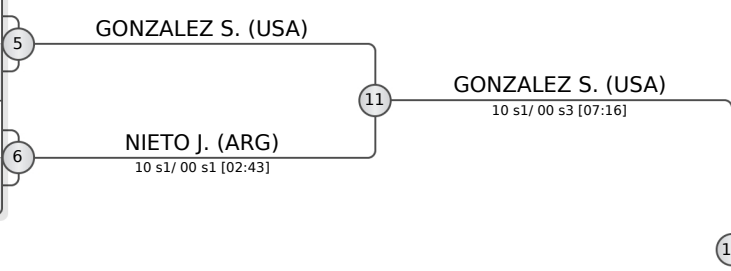

POOL D

	NGUYEN Nancy	USA
	SANTILLANA Heydi	COL
	AREVALO Marcela	ECU
	BOURQUE Charline	CAN

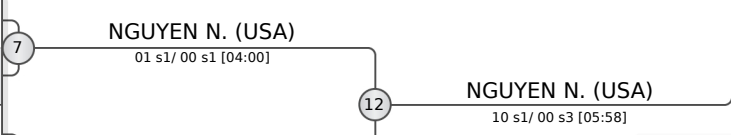

FINAL RESULTS		
1.	CARDOSO Kaillany	BRA
2.	NGUYEN Nancy	USA
3.	GONZALEZ Shavon	USA
3.	NIETO Joaquina	ARG
5.	SANDOVAL Renata	MEX
5.	ESPINA Hannelys	VEN
7.	FIGUEROA Iara	ARG
7.	SANTILLANA Heydi	COL

REPECHAGE

SANDOVAL R. (MEX)	13
JIMENEZ V. (CHI)	14
FIGUEROA I. (ARG)	14
NIETO J. (ARG)	15
SANTILLANA H. (COL)	16
BOURQUE C. (CAN)	16

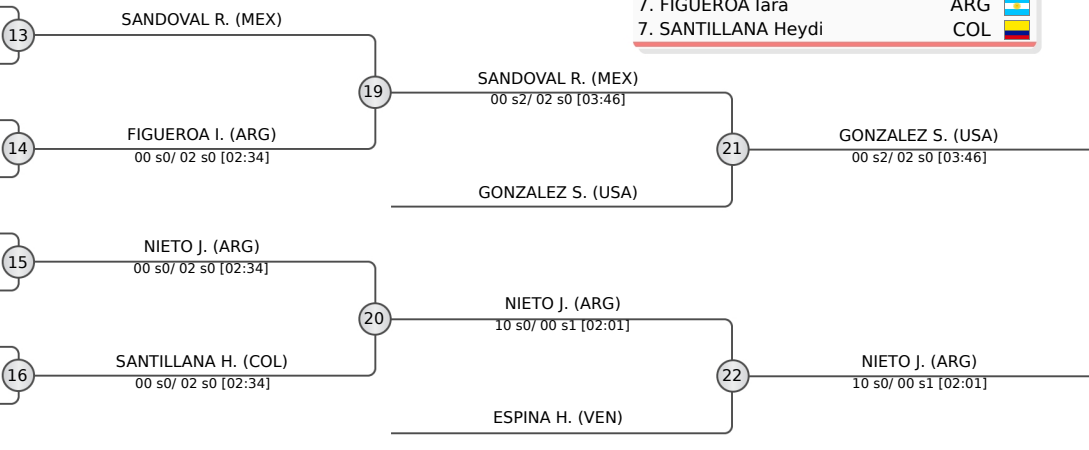



POOL A

OLAYA Brenda COL

POOL B

MINEQUE Zen CAN
 SANCHEZ LEDESMA Paula Constanza MEX

POOL C

CAMILO Dandara BRA

POOL D

SCHULTZ Mackenzie USA
 MURILLO Tania COL

REPECHAGE

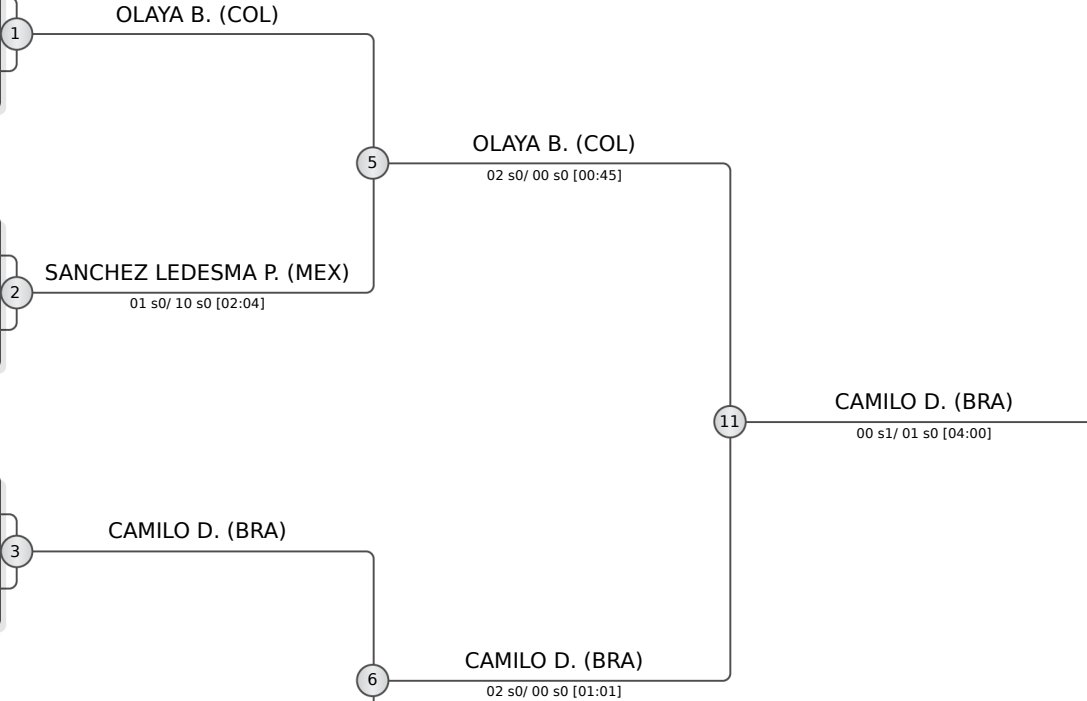
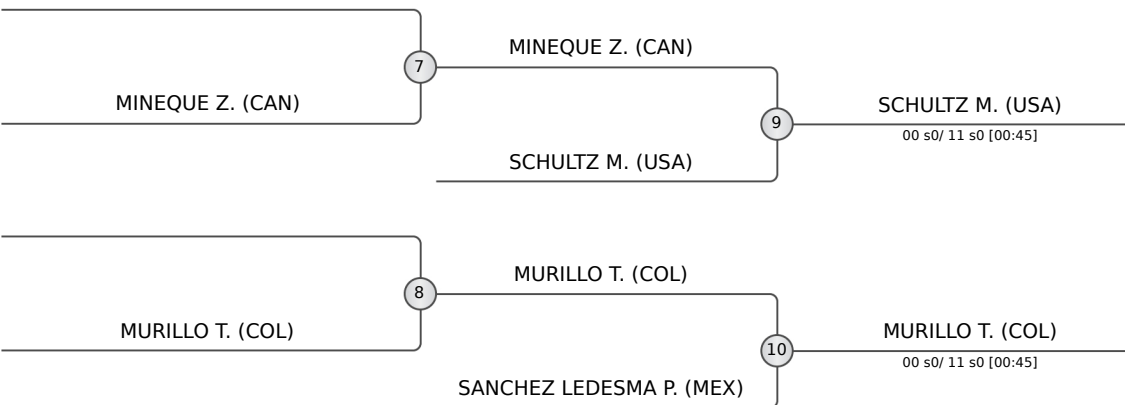

FINAL RESULTS		
1.	CAMILO Dandara	BRA
2.	OLAYA Brenda	COL
3.	SCHULTZ Mackenzie	USA
3.	MURILLO Tania	COL
5.	MINEQUE Zen	CAN
5.	SANCHEZ LEDESMA Paula Constanza	MEX





POOL A

	CASAS Kharla	CHI
	OLIVEIRA Olivia	BRA

1 CASAS K. (CHI)
 11 s0/ 01 s0 [00:54]

POOL B

	CHAVES GONZALEZ Arianna	CRC
	KOFMAN Alisa	CAN

2 KOFMAN A. (CAN)
 00 s0/ 10 s0 [00:23]

POOL C

	HERNANDEZ Valeria	CRC
	DAS CHAGAS PEREIRA Evellyn Vitoria	BRA

3 DAS CHAGAS PEREIRA E. (BRA)
 00 s0/ 10 s0 [00:45]

POOL D

	BALETRINI Jeslenny	VEN
--	--------------------	-----

4 BALETRINI J. (VEN)

REPECHAGE

OLIVEIRA O. (BRA)	7
CHAVES GONZALEZ A. (CRC)	

7 OLIVEIRA O. (BRA)
 10 s0/ 00 s0 [00:07]

HERNANDEZ V. (CRC)	8

8 HERNANDEZ V. (CRC)

10 CASAS K. (CHI)
 02 s0/ 00 s1 [02:45]

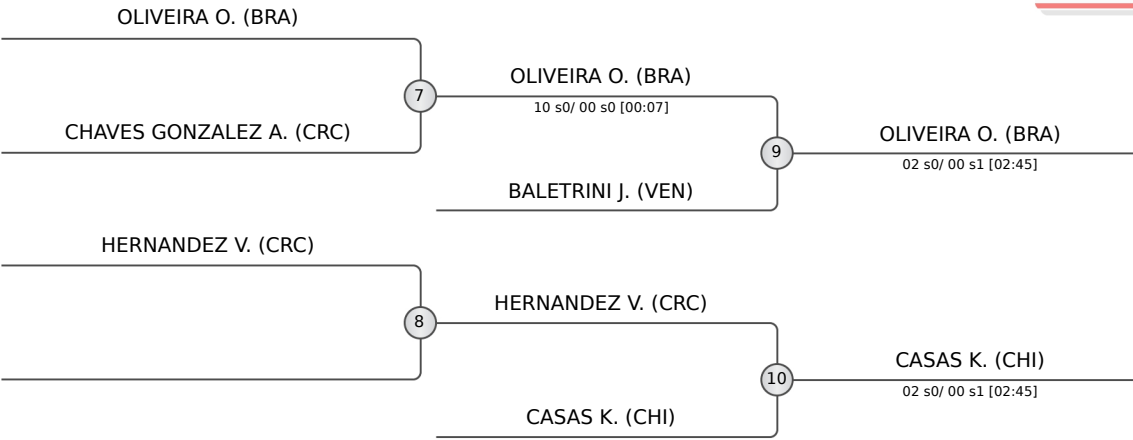

FINAL RESULTS		
1.	DAS CHAGAS PEREIRA Evellyn Vitoria	BRA
2.	KOFMAN Alisa	CAN
3.	OLIVEIRA Olivia	BRA
3.	CASAS Kharla	CHI
5.	BALETRINI Jeslenny	VEN
5.	HERNANDEZ Valeria	CRC

