



Ljubljana European Open 2025

Slovenia, Ljubljana, 8-9 Feb 2025

-60 kg
Seniors (39)

POOL A

LEUTGEB Daniel (AUT)	1	LEUTGEB D. (AUT)	
STARKEL David (SLO)	2	STARKEL D. (SLO)	33
DAFALLAH Ayoub (GBR)			001 s0/ 000 s2 [04:58]
GÓMEZ LLORENS Pedro (ESP)	3	GÓMEZ LLORENS P. (ESP)	
REA Diego (ITA)	4	REA D. (ITA)	34
			100 s1/ 000 s0 [04:00]
ANDRASI Marton (HUN)	5	ANDRASI M. (HUN)	
YANG Joshua (USA)	6	IGNACZAK M. (FRA)	35
IGNACZAK Maxime (FRA)			000 s0/ 010 s1 [04:00]
KLEPININ Oleksandr (UKR)	7	KLEPININ O. (UKR)	
MATEI Alexandru (ROU)	8	MATEI A. (ROU)	36
			000 s1/ 010 s1 [04:00]

POOL B

VELAZCO Christopher (USA)	9	VELAZCO C. (USA)	
WAIZENEGGER Jesse (SUI)	10	WAIZENEGGER J. (SUI)	37
			001 s1/ 000 s1 [04:00]
KAMITSIS Alexandros (CYP)	11	KAMITSIS A. (CYP)	
SUPERVIELLE Gabin (FRA)	12	SUPERVIELLE G. (FRA)	38
			000 s0/ 101 s0 [04:00]
FECZKO Csanad (HUN)	13	FECZKO C. (HUN)	
KIM Serhii (UKR)	14	STEFANELLI F. (ITA)	39
STEFANELLI Francesco Pio (ITA)			000 s3/ 100 s0 [05:18]
STEIN PADOA Daniel (ISR)	15	STEIN PADOA D. (ISR)	
IGNASIAK Ksawery (POL)	16	IGNASIAK K. (POL)	40
			100 s1/ 000 s1 [04:00]

POOL C

ADAMYAN Vache (AUT)	17	ADAMYAN V. (AUT)	
WAIZENEGGER Samuel (SUI)	18	GUILLARD A. (FRA)	41
GUILLARD Anatole (FRA)			000 s1/ 010 s0 [04:00]
ROSEN Roie (ISR)	19	ROSEN R. (ISR)	
COLLIN Tylor (CAN)	20	COLLIN T. (CAN)	42
			100 s0/ 000 s0 [04:00]
YANG Jonathan (USA)	21	YANG J. (USA)	
AVRAMENKO Danylo (UKR)	22	AVRAMENKO D. (UKR)	43
			100 s2/ 000 s1 [04:00]
CARRANZA MORENO Alberto (ESP)	23	VIDA A. (HUN)	44
VIDA Andras (HUN)			000 s0/ 100 s0 [04:00]
FITYKA Mateusz (POL)	24	FITYKA M. (POL)	44
			001 s1/ 000 s0 [05:02]

POOL D

BARROSO LOPEZ Luis (ESP)	25	BARROSO LOPEZ L. (ESP)	
VEKSLER Yehonatan (ISR)	26	VEKSLER Y. (ISR)	45
			000 s2/ 001 s2 [06:06]
ISAEV Ramazan (AUT)	27	TUPYTSKYI D. (UKR)	46
TUPYTSKYI Denys (UKR)			000 s0/ 100 s0 [04:00]
MANFERLOTTI Vincenzo (ITA)	28	MANFERLOTTI V. (ITA)	46
			001 s0/ 000 s0 [04:00]
NAJI David (HUN)	29	NAJI D. (HUN)	
ANDJELOVIC Rastko (SRB)	30	ANDJELOVIC R. (SRB)	47
			100 s0/ 000 s0 [04:00]
ANGHEL Andrei (ROU)	31	ANGHEL A. (ROU)	48
CALDWELL Benjamin (GBR)			010 s1/ 000 s1 [04:00]
LIMARE Vincent (FRA)	32	LIMARE V. (FRA)	48
			000 s2/ 100 s2 [05:41]

REPECHAGE

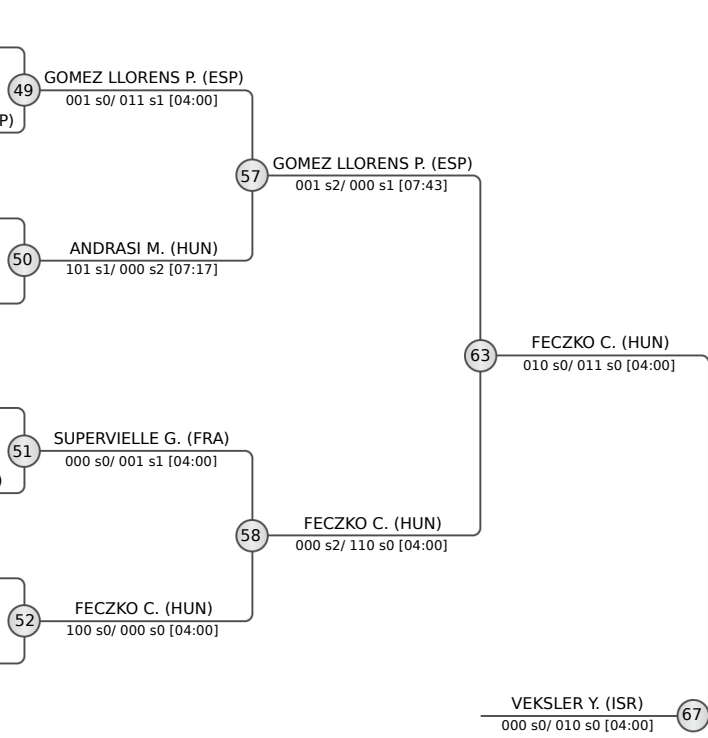
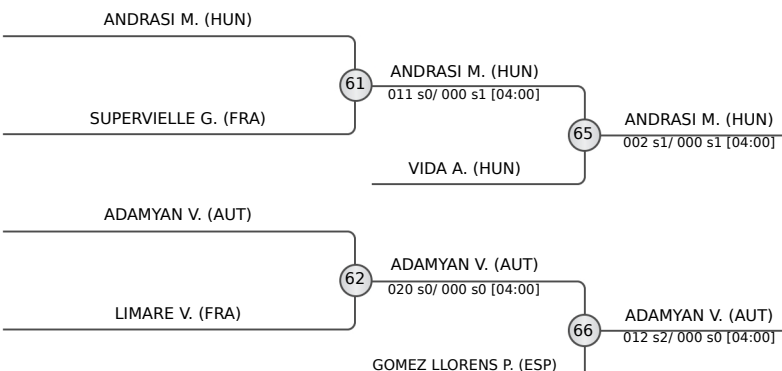

1. VEKSLER Yehonatan	ISR
2. FECZKO Csanad	HUN
3. ANDRASI Marton	HUN
5. ADAMYAN Vache	AUT
5. VIDA Andras	HUN
7. SUPERVIELLE Gabin	FRA
7. LIMARE Vincent	FRA





Ljubljana European Open 2025

Slovenia, Ljubljana, 8-9 Feb 2025

-66 kg
Seniors (44)

POOL A

	NIETO CHINARRO Adrian	ESP
	DE LUCA Ciro	ITA
	KREMERMAN Daniil	CAN
	JANEZASHVILI Giorgi	GEO
	ZIMMERMANN Marek	GER
	KRAVCHENKO Danylo	UKR
	MATHE Bence	HUN
	AUER Pascal	AUT
	GUTMAN Guy	ISR
	MACDONALD Neil	GBR
	DOKTOROV Denys	UKR

1	NIETO CHINARRO A. (ESP)	33	NIETO CHINARRO A. (ESP)	
2	KREMERMAN D. (CAN)	000 s1/ 002 s2 [04:00]	100 s1/ 000 s3 [04:00]	
3	JANEZASHVILI G. (GEO)	010 s0/ 000 s0 [04:00]	49	NIETO CHINARRO A. (ESP)
4	KRAVCHENKO D. (UKR)	34	JANEZASHVILI G. (GEO)	
5	MATHE B. (HUN)	001 s1/ 000 s1 [04:44]	100 s0/ 000 s2 [04:00]	
6	GUTMAN G. (ISR)	35	GUTMAN G. (ISR)	
7	MACDONALD N. (GBR)	002 s0/ 010 s0 [04:00]	50	GUTMAN G. (ISR)
8	DOKTOROV D. (UKR)	36	DOKTOROV D. (UKR)	
	000 s0/ 100 s0 [04:00]	111 s0/ 011 s1 [05:00]	57	GUTMAN G. (ISR)
		000 s0/ 100 s1 [04:00]	63	VAN HARTEN J. (NED)

POOL B

	CARGNELUTTI Francesco	ITA
	SUAREZ ARTELES Giovanni	ESP
	KLACAR Dani	CRO
	DVORACEK Antonin	CZE
	MARANDIAN Karo	UKR
	VAN HARTEN Jochem	NED
	GOMBAS Balint	HUN
	DEMETS Robbe	BEL
	BOECKER Florian	GER
	DUBINA Hlib	UKR
	KOKALJ Gasper	SLO

9	CARGNELUTTI F. (ITA)	37	KLACAR D. (CRO)	
10	KLACAR D. (CRO)	000 s0/ 010 s1 [04:00]	000 s2/ 001 s2 [04:00]	
11	MARANDIAN K. (UKR)	000 s0/ 100 s0 [04:00]	51	VAN HARTEN J. (NED)
12	VAN HARTEN J. (NED)	38	VAN HARTEN J. (NED)	
13	GOMBAS B. (HUN)	39	GOMBAS B. (HUN)	
14	DEMETS R. (BEL)	012 s0/ 000 s0 [04:00]	001 s0/ 000 s2 [07:49]	
15	DUBINA H. (UKR)	40	DUBINA H. (UKR)	
16	KOKALJ G. (SLO)	40	DUBINA H. (UKR)	
	100 s1/ 000 s3 [04:00]	52	GOMBAS B. (HUN)	
		100 s1/ 000 s0 [04:00]	58	VAN HARTEN J. (NED)
		010 s0/ 000 s1 [04:00]	67	VISKOV N. (UKR)

POOL C

	DE LUCA Alessio	ITA
	MAN Omer	ISR
	MARTIROSIAN Hahik	UKR
	TSATSALASHVILI Luka	CAN
	ICKES David	GER
	GARCIA OSADO Victor	ESP
	CAGGIANO Luca	ITA
	KALAITSIDIS Georgios	CYP
	VISKOV Nazar	UKR
	SZYMANSKI Szymon	POL
	YANG Jacob	USA

17	DE LUCA A. (ITA)	41	DE LUCA A. (ITA)	
18	MARTIROSIAN H. (UKR)	000 s0/ 100 s0 [04:00]	001 s1/ 000 s2 [07:04]	
19	ICKES D. (GER)	42	ICKES D. (GER)	
20	GARCIA OSADO V. (ESP)	000 s0/ 002 s1 [04:00]	110 s0/ 001 s1 [04:00]	
21	CAGGIANO L. (ITA)	43	KALAITSIDIS G. (CYP)	
22	KALAITSIDIS G. (CYP)	000 s0/ 110 s0 [04:00]	53	ICKES D. (GER)
23	VISKOV N. (UKR)	44	VISKOV N. (UKR)	
24	YANG J. (USA)	44	VISKOV N. (UKR)	
	100 s0/ 000 s0 [04:00]	54	VISKOV N. (UKR)	
	111 s1/ 000 s2 [04:00]	59	VISKOV N. (UKR)	
		000 s2/ 001 s0 [05:32]	64	VISKOV N. (UKR)

POOL D

	LIPARD Viljar	EST
	SINANOVIC Emil	MNE
	BOBOVICH Amit	ISR
	MORHOIEV Bekirbek	UKR
	BERNABEU RICO Jaume	ESP
	SEKNIJASVILI Tevdor	SRB
	YOTOV Boyan	BUL
	DELLO RUSSO Lino Andrea	GER
	ZADRAVEC Gabriel	SLO
	CELIKBILEK Loan	SUI
	ALTEMIROV Deny	BEL

25	LIPARD V. (EST)	45	LIPARD V. (EST)	
26	SINANOVIC E. (MNE)	001 s1/ 000 s0 [04:08]	100 s0/ 000 s2 [04:00]	
27	BERNABEU RICO J. (ESP)	000 s1/ 010 s0 [04:00]	55	BERNABEU RICO J. (ESP)
28	SEKNIJASVILI T. (SRB)	46	BERNABEU RICO J. (ESP)	
29	YOTOV B. (BUL)	47	YOTOV B. (BUL)	
30	DELLO RUSSO L. (GER)	012 s1/ 000 s0 [04:00]	56	ALTEMIROV D. (BEL)
31	CELIKBILEK L. (SUI)	48	ALTEMIROV D. (BEL)	
32	ALTEMIROV D. (BEL)	000 s0/ 102 s0 [04:00]	60	ALTEMIROV D. (BEL)
	000 s0/ 100 s0 [00:00]	61	GOMBAS B. (HUN)	
	000 s0/ 100 s0 [04:00]	62	ICKES D. (GER)	
	000 s0/ 110 s1 [04:34]	65	GOMBAS B. (HUN)	
	111 s0/ 000 s0 [04:00]	66	ICKES D. (GER)	
	000 s1/ 020 s0 [04:00]	66	GUTMAN G. (ISR)	

REPECHAGE

61	GOMBAS B. (HUN)	000 s0/ 100 s0 [00:00]
62	ICKES D. (GER)	100 s0/ 000 s0 [04:00]
65	GOMBAS B. (HUN)	001 s1/ 000 s1 [07:27]
66	ICKES D. (GER)	110 s1/ 000 s1 [04:00]

FINAL RESULTS	
1.	VISKOV Nazar
2.	VAN HARTEN Jochem
3.	GOMBAS Balint
3.	ICKES David
5.	ALTEMIROV Deny
5.	GUTMAN Guy
7.	NIETO CHINARRO Adrian
7.	BERNABEU RICO Jaume





Ljubljana European Open 2025

Slovenia, Ljubljana, 8-9 Feb 2025

-73 kg
Seniors (59)

POOL A

USA	YONEZUKA Jack	USA	1	YONEZUKA J. (USA)	33	YONEZUKA J. (USA)
ESP	GARCIA OBENSA Sergio	ESP	2	GARCIA OBENSA S. (ESP)	111 s2/ 000 s1 [04:00]	YONEZUKA J. (USA)
UKR	KULIESHOV Nazar	UKR	3	CHARLES C. (GBR)	100 s0/ 000 s0 [04:00]	49
GBR	CHARLES Cameron	GBR	3	CHARLES C. (GBR)	001 s1/ 000 s1 [04:00]	YONEZUKA J. (USA)
SLO	KELAVA Goran	SLO	4	GABOR A. (HUN)	000 s1/ 010 s2 [05:01]	57
CAN	MERCIER-ROSS Felix	CAN	4	GABOR A. (HUN)	000 s1/ 001 s1 [05:51]	RUBECA L. (ITA)
HUN	GABOR Aron	HUN	4	GABOR A. (HUN)	000 s1/ 010 s2 [05:01]	50
ESP	ARANDA OLALLA Jose Antonio	ESP	5	RUBECA L. (ITA)	000 s1/ 002 s0 [04:00]	RUBECA L. (ITA)
ITA	RUBECA Luca	ITA	5	RUBECA L. (ITA)	001 s1/ 000 s1 [04:00]	63
GER	ABELTSHAUSER Kevin	GER	6	KARIMOV C. (CZE)	000 s2/ 100 s2 [04:51]	58
CZE	KARIMOV Chusniddin	CZE	6	KARIMOV C. (CZE)	000 s2/ 100 s2 [04:51]	KHALIDOV S. (UKR)
ISR	GINER Oron	ISR	7	MARINX R. (BEL)	000 s1/ 010 s2 [04:00]	67
BEL	MARINX Ray	BEL	7	MARINX R. (BEL)	000 s1/ 010 s2 [04:00]	67
AUT	AUST Phillip	AUT	8	AUST P. (AUT)	100 s0/ 000 s0 [04:00]	67
SUI	MATT Naim	SUI	8	AUST P. (AUT)	100 s0/ 000 s0 [04:00]	67

POOL B

AUT	GASSNER Samuel	AUT	9	GASSNER S. (AUT)	37	GASSNER S. (AUT)
FIN	KORHONEN Roope	FIN	10	VELICKOVIC B. (SRB)	020 s0/ 000 s0 [04:00]	51
SRB	VELICKOVIC Bogdan	SRB	10	VELICKOVIC B. (SRB)	000 s3/ 100 s1 [07:19]	58
BEL	GAZALOEV Mouhammad	BEL	11	GAZALOEV M. (BEL)	001 s2/ 000 s2 [04:29]	63
ITA	SALVO Samuel	ITA	11	GAZALOEV M. (BEL)	001 s2/ 000 s2 [04:29]	63
ESP	MACALOU SOUCKO Moussa	ESP	12	MACALOU SOUCKO M. (ESP)	110 s0/ 000 s0 [04:00]	52
GBR	GOGINASHVILI Irakli	GBR	12	MACALOU SOUCKO M. (ESP)	110 s0/ 000 s0 [04:00]	52
ROU	DZITAC Ioan	ROU	13	DZITAC I. (ROU)	000 s0/ 004 s1 [04:00]	67
HUN	SZABO Aron	HUN	14	KHALIDOV S. (UKR)	010 s3/ 110 s1 [05:35]	67
UKR	KHALIDOV Said-Magomed	UKR	14	KHALIDOV S. (UKR)	010 s3/ 110 s1 [05:35]	67
BUL	HRISTOV Alen	BUL	15	THIJSSSEN N. (NED)	000 s0/ 010 s0 [04:00]	67
NED	THIJSSSEN Niels	NED	15	THIJSSSEN N. (NED)	000 s0/ 010 s0 [04:00]	67
SLO	BRENCE Miha	SLO	16	WAIZENEGGER F. (SUI)	000 s1/ 001 s1 [04:00]	67
SUI	WAIZENEGGER Freddy	SUI	16	WAIZENEGGER F. (SUI)	000 s1/ 001 s1 [04:00]	67

POOL C

GER	GABLER Alexander Bernd	GER	17	GABLER A. (GER)	41	GABLER A. (GER)
NED	VAN HARTEN Matthijs	NED	18	KLACAR R. (CRO)	000 s0/ 001 s1 [04:00]	53
CRO	KLACAR Robert	CRO	18	KLACAR R. (CRO)	000 s0/ 001 s1 [04:00]	53
ESP	CANO MARTOS Alvaro	ESP	19	CANO MARTOS A. (ESP)	010 s1/ 000 s1 [04:00]	59
UKR	IADOV Bogdan	UKR	19	CANO MARTOS A. (ESP)	010 s1/ 000 s1 [04:00]	59
SRB	LOJANIC Marko	SRB	20	KASERER A. (AUT)	001 s2/ 000 s0 [04:38]	64
AUT	KASERER Alexander	AUT	20	KASERER A. (AUT)	001 s2/ 000 s0 [04:38]	64
BEL	BATCHAEV Zelemkhan	BEL	21	BATCHAEV Z. (BEL)	100 s0/ 000 s0 [04:00]	60
GBR	SHORT Oliver	GBR	21	BATCHAEV Z. (BEL)	100 s0/ 000 s0 [04:00]	60
ESP	ALVEZ DUARTE David Ignacio	ESP	22	BARCZIKAY A. (HUN)	000 s1/ 001 s1 [04:00]	60
HUN	BARCZIKAY Akos	HUN	22	BARCZIKAY A. (HUN)	000 s1/ 001 s1 [04:00]	60
SLO	KAVCIC Jaka	SLO	23	KAVCIC J. (SLO)	111 s1/ 001 s2 [04:00]	60
CAN	DE CARDAILLAC Frederic	CAN	23	KAVCIC J. (SLO)	111 s1/ 001 s2 [04:00]	60
ITA	MELLA Edoardo	ITA	24	BORS DUMITRESCU L. (ROU)	000 s0/ 100 s0 [04:00]	60
ROU	BORS DUMITRESCU Lucian	ROU	24	BORS DUMITRESCU L. (ROU)	000 s0/ 100 s0 [04:00]	60

POOL D

SLO	HOJAK Martin	SLO	25	HOJAK M. (SLO)	45	HOJAK M. (SLO)
CAN	HACHEMI Yanis	CAN	26	SHUHALIEIEV A. (ESP)	000 s0/ 100 s0 [04:00]	55
ESP	SHUHALIEIEV Anton	ESP	26	SHUHALIEIEV A. (ESP)	000 s0/ 100 s0 [04:00]	55
POL	LOSKA Olaf	POL	27	AINSEBA Z. (FRA)	000 s2/ 001 s1 [05:46]	60
FRA	AINSEBA Zakary	FRA	27	AINSEBA Z. (FRA)	000 s2/ 001 s1 [05:46]	60
UKR	KAZIMIROV Vladyslav	UKR	28	PONNET D. (BEL)	010 s1/ 020 s1 [04:30]	56
BEL	PONNET Dries	BEL	28	PONNET D. (BEL)	010 s1/ 020 s1 [04:30]	56
FIN	DJOUKAEV Turpal	FIN	29	WAIZENEGGER J. (SUI)	000 s1/ 010 s1 [05:42]	56
SUI	WAIZENEGGER John	SUI	29	WAIZENEGGER J. (SUI)	000 s1/ 010 s1 [05:42]	56
HUN	POKK Armand	HUN	30	POKK A. (HUN)	100 s0/ 000 s3 [04:00]	56
ISR	ITSHAK Yonatan	ISR	30	POKK A. (HUN)	100 s0/ 000 s3 [04:00]	56
USA	BELFER Nathan	USA	31	BOLDIS R. (ROU)	100 s2/ 000 s2 [03:33]	66
ROU	BOLDIS Robert	ROU	31	BOLDIS R. (ROU)	100 s2/ 000 s2 [03:33]	66
ESP	FERNANDEZ CAMPILLO Diego	ESP	32	FERNANDEZ CAMPILLO D. (ESP)	020 s0/ 000 s1 [04:00]	66
ITA	BRUDETTI Luigi	ITA	32	FERNANDEZ CAMPILLO D. (ESP)	020 s0/ 000 s1 [04:00]	66

REPECHAGE

YONEZUKA J. (USA)	61	YONEZUKA J. (USA)	65
GAZALOEV M. (BEL)	102 s0/ 000 s0 [04:00]	YONEZUKA J. (USA)	010 s1/ 000 s0 [04:00]
BORS DUMITRESCU L. (ROU)			
GABLER A. (GER)	62	GABLER A. (GER)	66
WAIZENEGGER J. (SUI)	001 s1/ 000 s0 [05:54]	GABLER A. (GER)	010 s2/ 000 s0 [04:00]
RUBECA L. (ITA)			

FINAL RESULTS

1. KHALIDOV Said-Magomed UKR
2. AINSEBA Zakary FRA
3. YONEZUKA Jack USA
4. GABLER Alexander Bernd GER
5. BORS DUMITRESCU Lucian ROU
5. RUBECA Luca ITA
7. GAZALOEV Mouhammad BEL
7. WAIZENEGGER John SUI





Ljubljana European Open 2025

Slovenia, Ljubljana, 8-9 Feb 2025

-81 kg
Seniors (49)

POOL A

1	DRZYMAL Pawel (POL)	33	DRZYMAL P. (POL)
2	BADASH Iftach (ISR)	34	PIPPIA L. (ITA)
3	GEROSA Loic (SUI)	35	TOTH B. (HUN)
4	PIPPIA Luigi (ITA)	36	KOLOBOV V. (UKR)
5	STANIMIROVIC Vukan (SRB)		
6	NOACK Gerrit (GER)		
7	TOTH Benedek (HUN)		
8	NASCHCHO Issa (AUT)		
	MECILOSEK Jus (SLO)		
	KOLOBOV Vladyslav (UKR)		
	MARGELIDON Arthur (CAN)		
	VAN DUN Mo (NED)		

POOL B

9	SILOT Johan (USA)	37	SILOT J. (USA)
10	VAGO Levente (HUN)	38	FOUBERT K. (BEL)
11	ZOROTOVIC Luka (CRO)	39	YOUNG K. (CAN)
12	BAZTAN MERCHAN Inaki (ESP)	40	ARIE O. (ISR)
13	THOMAS Peter (GER)		
14	FOUBERT Karel (BEL)		
15	YOUNG Keagan (CAN)		
16	CAMPBELL Logan (GBR)		
	FRONTAUREA Matteo (ITA)		
	GWOZDZ Sebastian (POL)		
	GARDASEVIC Nikola (MNE)		
	ARIE Ofir (ISR)		

POOL C

17	PEREZ Jorge (CHI)	41	GARDASEVIC N. (MNE)
18	GARDASEVIC Nebojsa (MNE)	42	BELLINI A. (ITA)
19	RADVANSZKI Szilard (ROU)	43	STARK V. (GER)
20	BELLINI Alessandro (ITA)	44	BA M. (ESP)
21	SAHIR Stanislav (UKR)		
22	KAUN Sebastian (GER)		
23	STARK Vladimir (GER)		
24	POPOVICI David (CAN)		
	PLANTAK Aljaz (SLO)		
	SOJKA Alexandr (CZE)		
	BA Mamaoudou Kindi (ESP)		
	ARGOV Or (ISR)		

POOL D

25	HERKOVIC Nace (SLO)	45	HERKOVIC N. (SLO)
26	ELEZ Vuk (SRB)	46	TSURKAN I. (UKR)
27	TYRRELL Rory (GBR)	47	OULEVEY T. (SUI)
28	HERNANDEZ JR Ramon (USA)	48	GOLLAND C. (GER)
29	KROL Dominik (POL)		
30	TSURKAN Igor (UKR)		
31	TOTH Botond (HUN)		
32	OULEVEY Thien (SUI)		
	TAMA Anthony (FRA)		
	SNIJDER'S Thomas (NED)		
	GAGNON Olivier (CAN)		
	GOLLAND Caspar (GER)		

REPECHAGE

61	KOLOBOV V. (UKR)	65	KOLOBOV V. (UKR)
	SILOT J. (USA)		STARK V. (GER)
	GARDASEVIC N. (MNE)		
62	OULEVEY T. (SUI)	66	YOUNG K. (CAN)
	OULEVEY T. (SUI)		

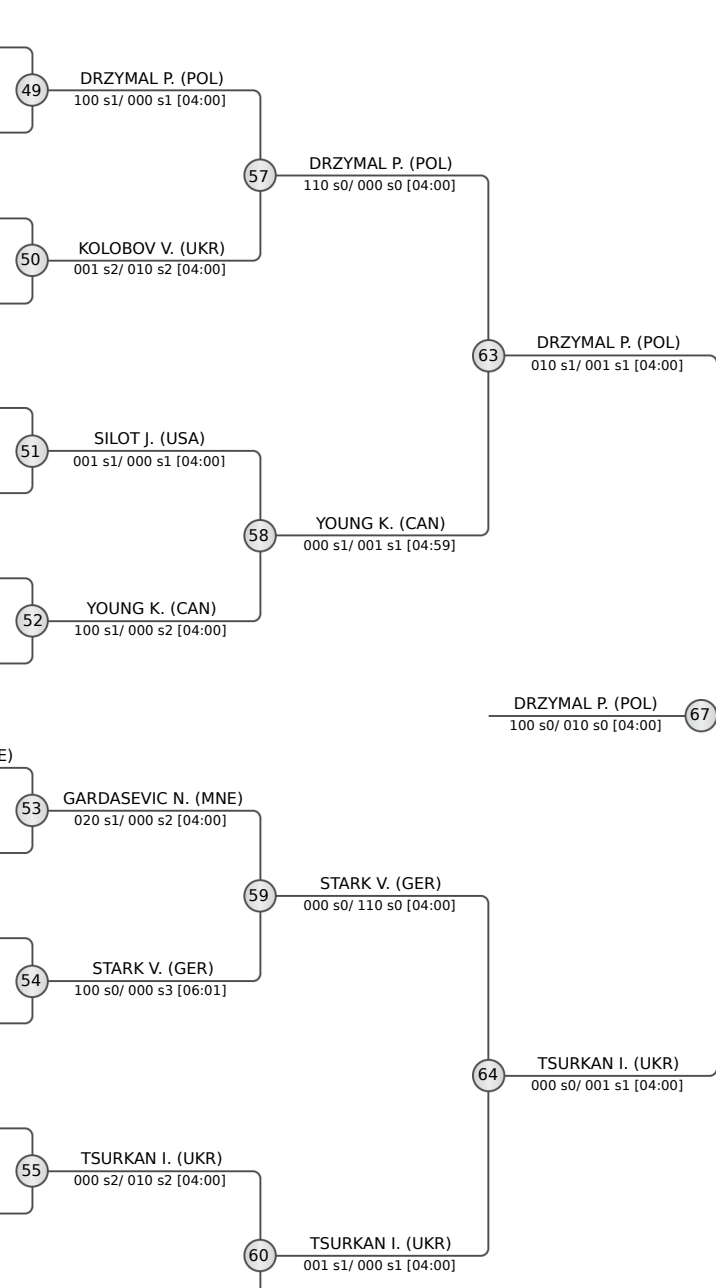

FINAL RESULTS		
1.	DRZYMAL Pawel	POL
2.	TSURKAN Igor	UKR
3.	KOLOBOV Vladyslav	UKR
4.	YOUNG Keagan	CAN
5.	STARK Vladimir	GER
5.	OULEVEY Thien	SUI
7.	SILOT Johan	USA
7.	GARDASEVIC Nebojsa	MNE





Ljubljana European Open 2025

Slovenia, Ljubljana, 8-9 Feb 2025

-90 kg
Seniors (33)

POOL A

1	NIETO TRINIDAD Daniel	ESP	1	NIETO TRINIDAD D. (ESP)
2	POHORALY Jakub	CZE	2	POHORALY J. (CZE)
3	LAVI Yaheli	ISR	3	LAVI Y. (ISR)
4	NIKCEVIC Stevan	MNE	4	NIKCEVIC S. (MNE)
5	GAULIN Guillaume	CAN	5	GAULIN G. (CAN)
6	SUFAJ Ardian	CRO	6	SUFAJ A. (CRO)
7	LACKOVIC Narsej	SLO	7	LACKOVIC N. (SLO)
8	VALIEIEV Tymur	UKR	8	VALIEIEV T. (UKR)

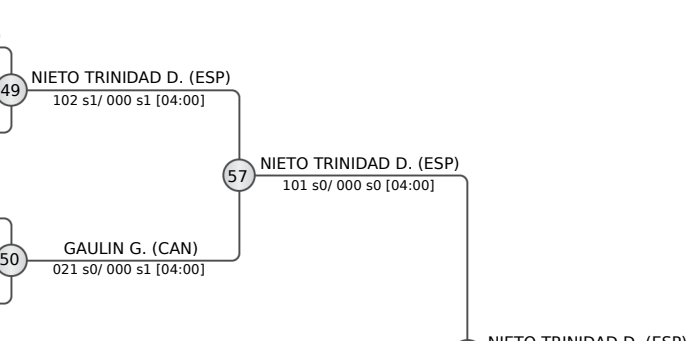

POOL B

9	KUTENKOV Ivan	UKR	9	KUTENKOV I. (UKR)
10	GAUTSCHI Simon	SUI	10	GAUTSCHI S. (SUI)
11	MIKLOSVOLGYI Daniel	HUN	11	CHRISTIAENS N. (BEL)
12	CHRISTIAENS Noah	BEL	12	CHRISTIAENS N. (BEL)
13	HASIC Kerim	BIH	13	HASIC K. (BIH)
14	SANTAMARIA RODRIGUEZ Aaron	ESP	14	SANTAMARIA RODRIGUEZ A. (ESP)
15	MILANOV Djordje	SRB	15	MILANOV D. (SRB)
16	SHEPEL Vitalii	UKR	16	SHEPEL V. (UKR)
17	SIVAN Roy	ISR	17	SIVAN R. (ISR)

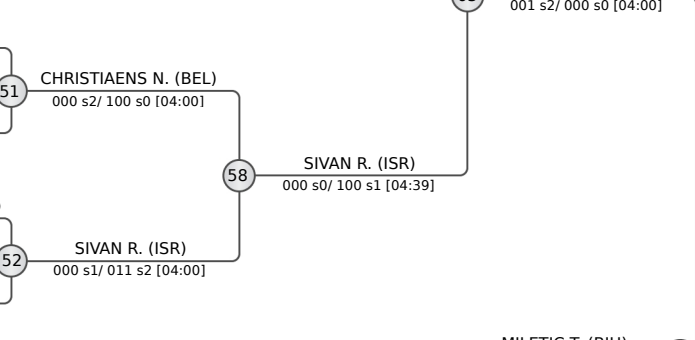

POOL C

17	MILETIC Toni	BIH	17	MILETIC T. (BIH)
18	PINTERA Daniel	CZE	18	PINTERA D. (CZE)
19	RAICEVIC Novo	MNE	19	RAICEVIC N. (MNE)
20	KRYZHANSKYI Marat	UKR	20	KRYZHANSKYI M. (UKR)
21	BULIC Josip	CRO	21	BULIC J. (CRO)
22	MOLINA GENER William	ESP	22	MOLINA GENER W. (ESP)
23	SALVETTI Elia	ITA	23	SALVETTI E. (ITA)
24	BEN HAROCH Segev	ISR	24	BEN HAROCH S. (ISR)

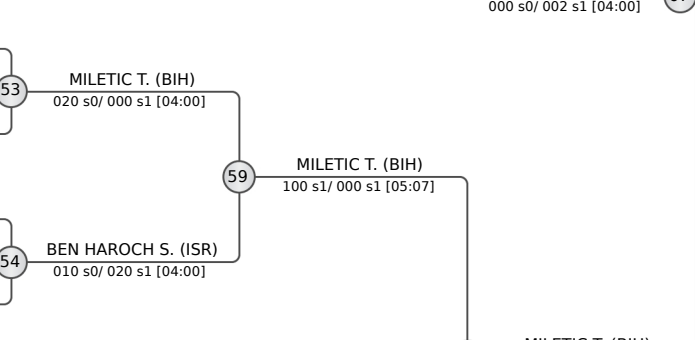

POOL D

25	NYZHNYK Oleksandr	USA	25	NYZHNYK O. (USA)
26	KANEVETS Artur	FIN	26	KANEVETS A. (FIN)
27	SZTANKO Daniel	HUN	27	SZTANKO D. (HUN)
28	GUNCHENKO Stanislav	UKR	28	GUNCHENKO S. (UKR)
29	L HERBIER Teo	FRA	29	L HERBIER T. (FRA)
30	MARTINEZ COIN Marcos	ESP	30	MARTINEZ COIN M. (ESP)
31	DUYCK Jarne	BEL	31	DUYCK J. (BEL)
32	MANDIC Vojin	SRB	32	MANDIC V. (SRB)

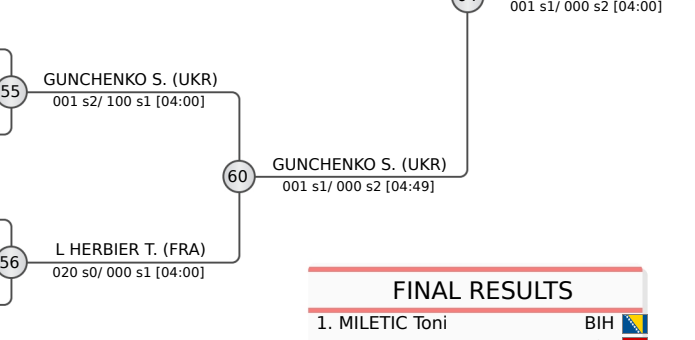

REPECHAGE

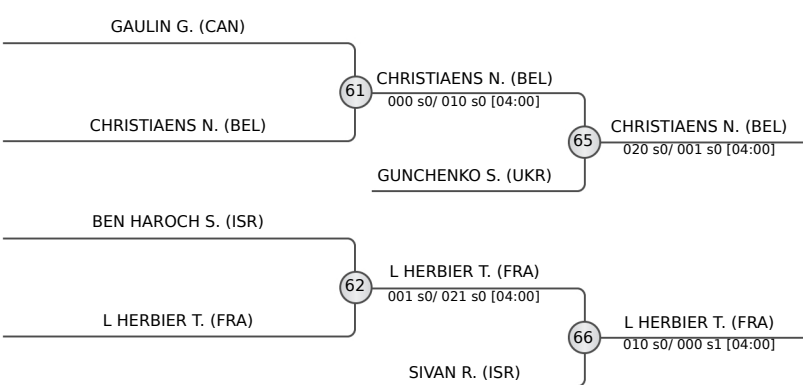

FINAL RESULTS		
1.	MILETIC Toni	BIH
2.	NIETO TRINIDAD Daniel	ESP
3.	CHRISTIAENS Noah	BEL
3.	L HERBIER Teo	FRA
5.	GUNCHENKO Stanislav	UKR
5.	SIVAN Roy	ISR
7.	GAULIN Guillaume	CAN
7.	BEN HAROCH Segev	ISR





Ljubljana European Open 2025

Slovenia, Ljubljana, 8-9 Feb 2025

-100 kg
Seniors (25)

POOL A

	BOEHLER Laurin	AUT
	DUDY David	CZE
	CHERKAI Oleksandr	UKR
	CAUSSE Jared	USA
	HAVASI Balint	HUN
	VRHOVNIK Marko	SLO
	BASCHIN Jannis	GER

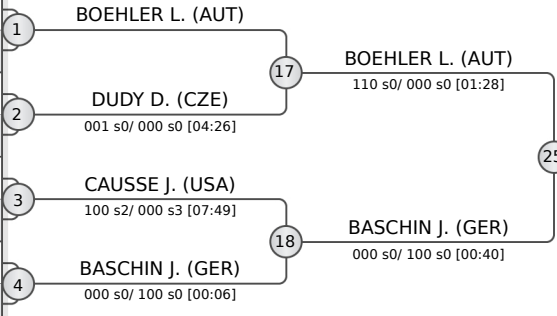

POOL B

	CARLETTI Jean	ITA
	WALENCIAK Michal	POL
	YERSHOV Oleksii	UKR
	ARSENIE Rares	ROU
	BAUNE Evan	FRA
	BORCHASHVILLI Adam	AUT

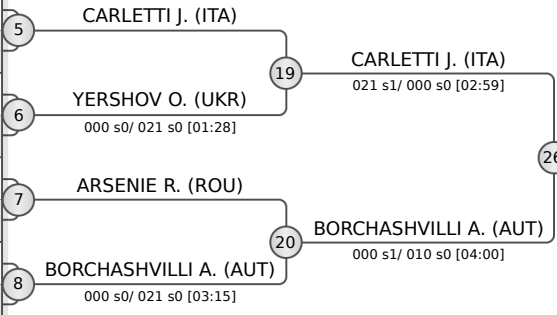

POOL C

	BERGAMELLI Enrico	ITA
	SIBISAN Alexandru	ROU
	KENDERESI Peter	HUN
	BEZDEK Martin	CZE
	ROZGA Ivan	CRO
	YUDANOV Nikita	UKR

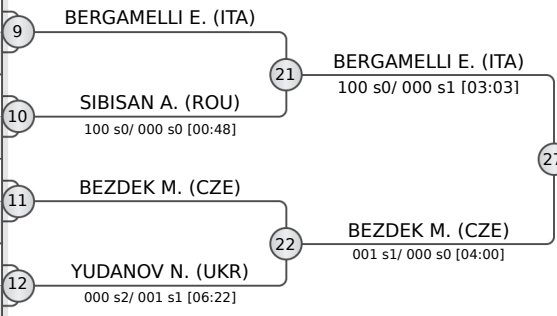

POOL D

	PAVLIUKOV Andzhei	IJF
	GORANOVIC Petar	MNE
	BERTALANIC ZIZEK Gal	SLO
	SHELL Joes	NED
	NIEDERDORFER Michael	AUT
	LHOTZKY Frantisek	CZE

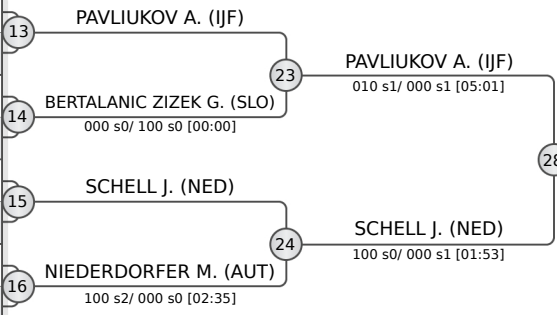

REPECHAGE

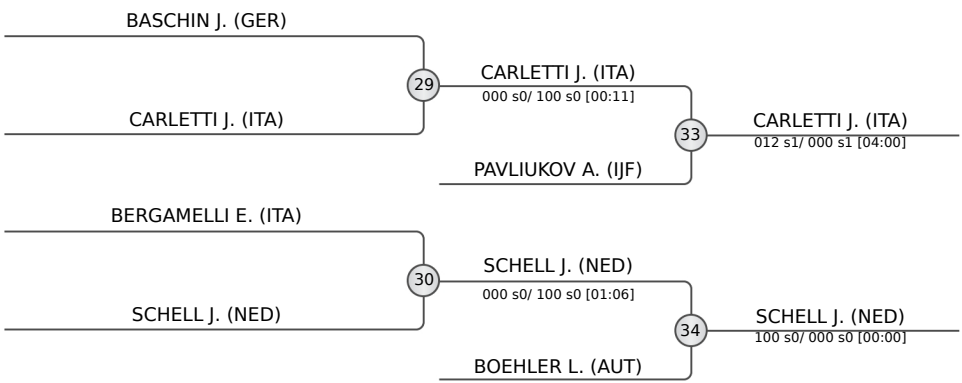

1.	BORCHASHVILLI Adam	AUT
2.	BEZDEK Martin	CZE
3.	CARLETTI Jean	ITA
3.	SHELL Joes	NED
5.	PAVLIUKOV Andzhei	IJF
5.	BOEHLER Laurin	AUT
7.	BASCHIN Jannis	GER
7.	BERGAMELLI Enrico	ITA





Ljubljana European Open 2025

Slovenia, Ljubljana, 8-9 Feb 2025

+ 100 kg
Seniors (15)

POOL A

	VRACAR Igor	SRB
	HEGYI Stephan	AUT
	MASAK Marek-Adrian	EST

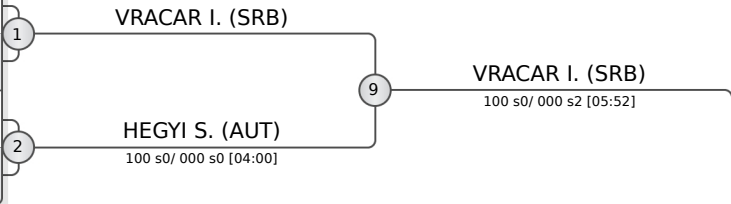

POOL B

	DUBRETA Anto	MNE
	SVIRYD Mikita	CRO
	CSERKASZOV Mihaly	HUN
	OMELCHENKO Yaroslav	UKR

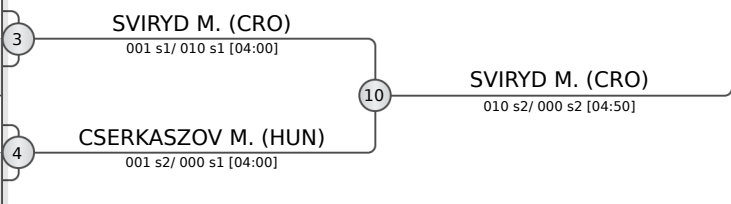

POOL C

	SOLIS Francisco	CHI
	VRANKAR Blaz	SLO
	SERBAN Eduard	ROU
	BALOGH Janos	HUN

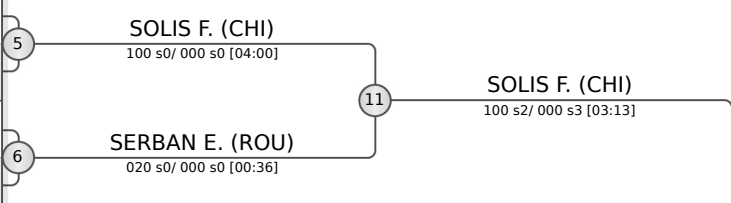

POOL D

	TERESINSKI Grzegorz	POL
	NDAO Yves	BEL
	HRYBYK Mykola	UKR
	DOBOS Levente	HUN

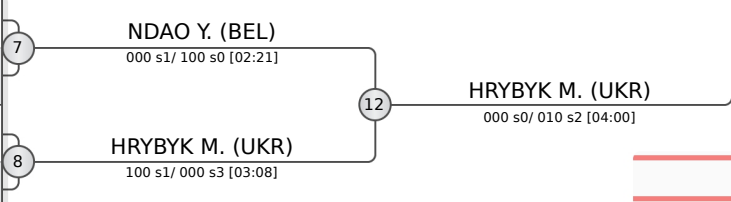

FINAL RESULTS		
1.	SOLIS Francisco	CHI
2.	SVIRYD Mikita	CRO
3.	HEGYI Stephan	AUT
3.	NDAO Yves	BEL
5.	HRYBYK Mykola	UKR
5.	VRACAR Igor	SRB
7.	CSERKASZOV Mihaly	HUN
7.	SERBAN Eduard	ROU

REPECHAGE

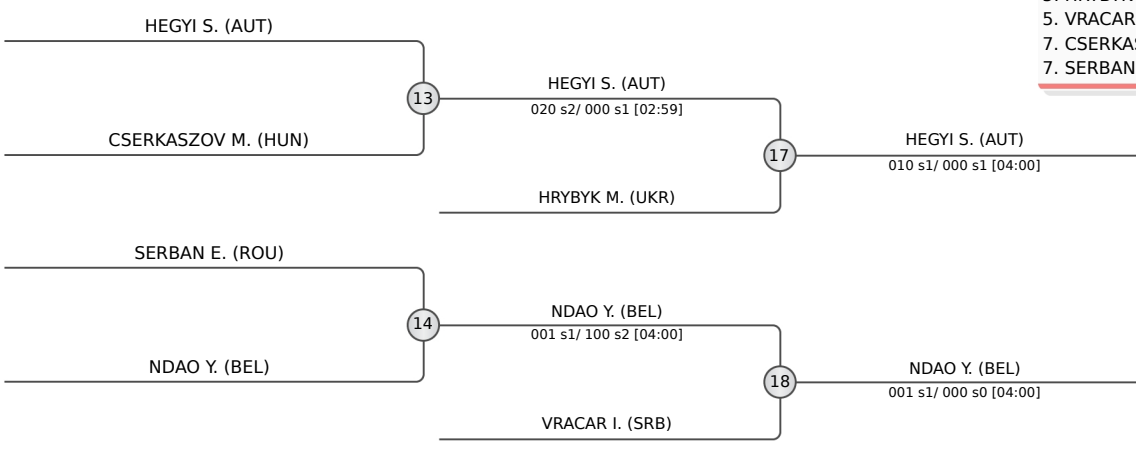



Ljubljana European Open 2025

Slovenia, Ljubljana, 8-9 Feb 2025

-48 kg
Seniors (21)

POOL A

	KOSZEGI Rebeka Rita	HUN
	PETITTO Sofia	ITA
	RODONAIA Julieta	GEO
	TURMEL Marie-Lune	CAN
	BEORLEGUI OSES Marta	ESP
	GUARDUCCI Elena	ITA

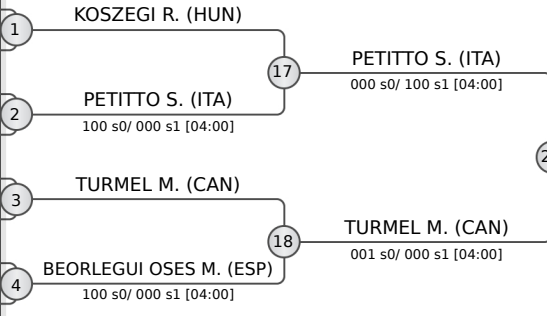

POOL B

	SZELECZKI Szabina	HUN
	FROBENIUS Hannah	GER
	ADRASTI Elisa	ITA
	GILLY Coralie	FRA
	WOZNIAK Zuzanna	POL

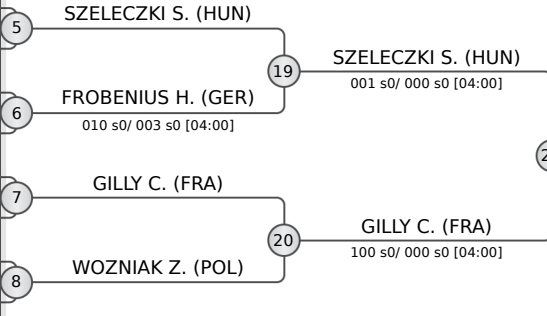

POOL C

	QUACH Heidi	CAN
	KOSTANJEVEC Arabela	SLO
	IOVINO Anna	ITA
	MILIC Nevena	SRB
	FALCON SANCHEZ Zuleima Del Carmen	ESP

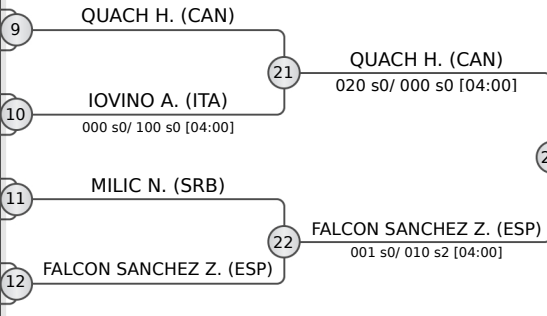

POOL D

	GILLY Marine	FRA
	ONYSK Oliwia	POL
	PEHERSTORFER Lisa	AUT
	MAZZOLA Sofia	ITA
	DIAZ HERNANDEZ Aitana	ESP

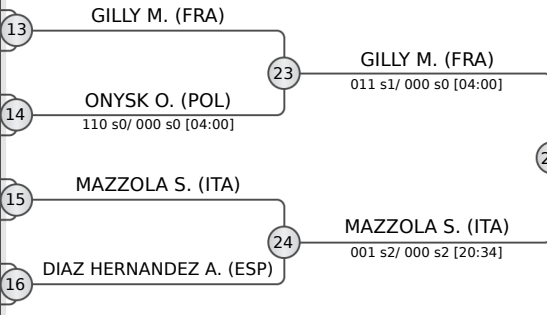

REPECHAGE

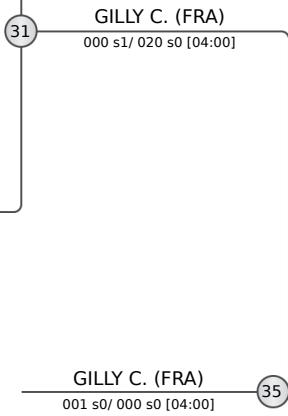
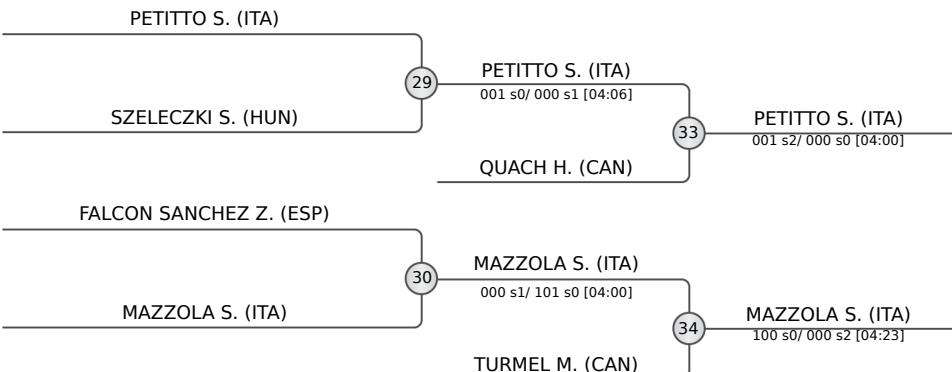

1.	GILLY Coralie	FRA
2.	GILLY Marine	FRA
3.	PETITTO Sofia	ITA
3.	MAZZOLA Sofia	ITA
5.	QUACH Heidi	CAN
5.	TURMEL Marie-Lune	CAN
7.	SZELECZKI Szabina	HUN
7.	FALCON SANCHEZ Zuleima Del Carmen	ESP





Ljubljana European Open 2025

Slovenia, Ljubljana, 8-9 Feb 2025

-52 kg
Seniors (22)

POOL A

	METROT Lea	FRA	1	METROT L. (FRA)
	KAISER Franziska	AUT	2	KAISER F. (AUT)
	STAKHOV Nicole	GER		100 s0/ 000 s0 [01:04]
	BEORLEGUI OSES Paula	ESP	3	BEORLEGUI OSES P. (ESP)
	LEVCHENKO Anastasiia	UKR	4	LEVCHENKO A. (UKR)

POOL B

	FINESTRONE Ilaria	ITA	5	FINESTRONE I. (ITA)
	KORCAKOVA Marketa	CZE	6	MIROSHNICHENKO M. (UKR)
	MIROSHNICHENKO Marharyta	UKR		000 s0/ 002 s1 [04:00]
	KLIMCZAK Kinga	POL	7	KLIMCZAK K. (POL)
	MAMIRA Luca	HUN	8	MAMIRA L. (HUN)
	VAUHKONEN Erika	FIN		100 s0/ 000 s2 [05:39]

POOL C

	BEATON Evelyn	CAN	9	BEATON E. (CAN)
	CUQ Pauline	FRA	10	CUQ P. (FRA)
	MIHHAILOVA Darja	EST		010 s0/ 000 s1 [04:00]
	BORODINA Anna	UKR	11	BORODINA A. (UKR)
	JUTTNER Janka	HUN	12	JUTTNER J. (HUN)

POOL D

	KELLER Rebeka	HUN	13	KELLER R. (HUN)
	MASTNAK Zarja	SLO	14	STELLA G. (ITA)
	STELLA Gaia	ITA		000 s2/ 001 s1 [05:19]
	CATANA Luciana	ROU	15	CATANA L. (ROU)
	MARTIN GALLARDO Patricia	ESP	16	MARTIN GALLARDO P. (ESP)
	SHTEFANIAK Yuliia	UKR		100 s2/ 000 s1 [05:24]

REPECHAGE

BEORLEGUI OSES P. (ESP)	29	BEORLEGUI OSES P. (ESP)	33	BEORLEGUI OSES P. (ESP)
MAMIRA L. (HUN)		001 s0/ 000 s0 [04:00]		010 s1/ 000 s0 [04:00]
BEATON E. (CAN)		STELLA G. (ITA)		
CATANA L. (ROU)	30	CATANA L. (ROU)	34	FINESTRONE I. (ITA)
CATANA L. (ROU)		000 s1/ 101 s1 [03:48]		000 s2/ 001 s2 [10:01]
		FINESTRONE I. (ITA)		

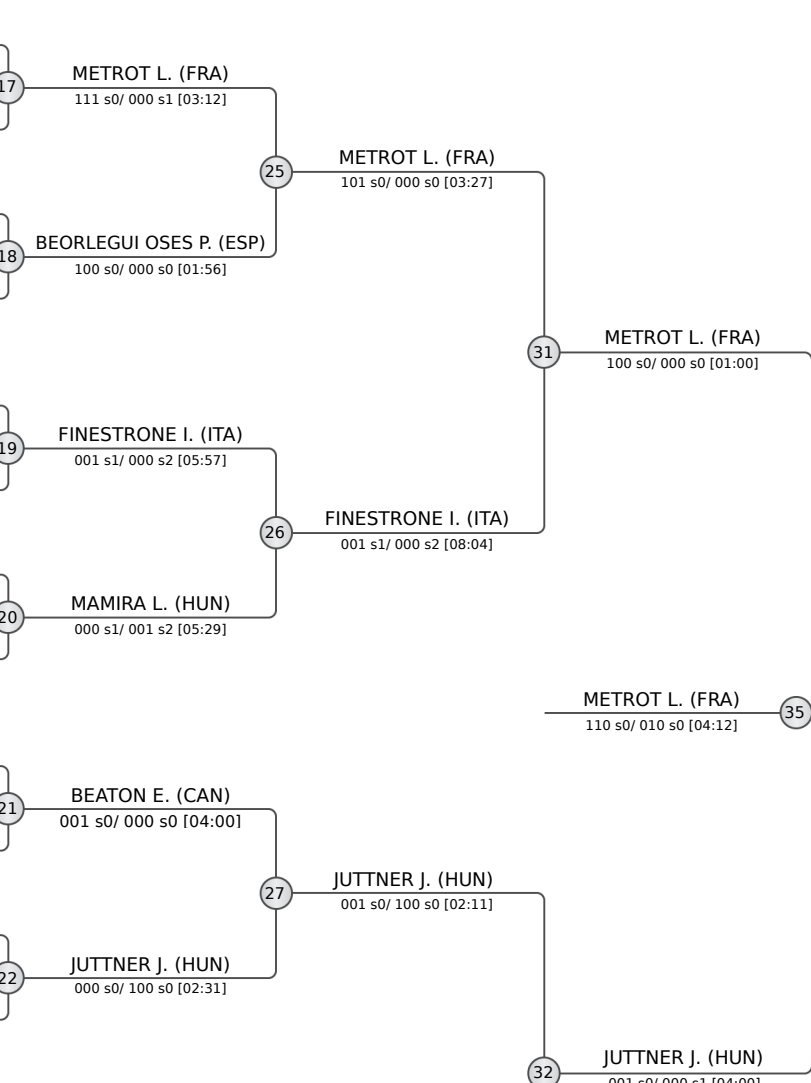

FINAL RESULTS		
1.	METROT Lea	FRA
2.	JUTTNER Janka	HUN
3.	BEORLEGUI OSES Paula	ESP
3.	FINESTRONE Ilaria	ITA
5.	STELLA Gaia	ITA
5.	CATANA Luciana	ROU
7.	MAMIRA Luca	HUN
7.	BEATON Evelyn	CAN





Ljubljana European Open 2025

Slovenia, Ljubljana, 8-9 Feb 2025

-57 kg
Seniors (28)

POOL A

	WILSON CLARET Malin	ESP
	NELSON Leana	USA
	TSIKLAURI Nino	GEO
	DE CARVALHO Alya	FRA
	MATIKAINEN Pihla	FIN
	CAGGIANO Giulia	ITA
	INSUA IGLESIAS Andrea	ESP

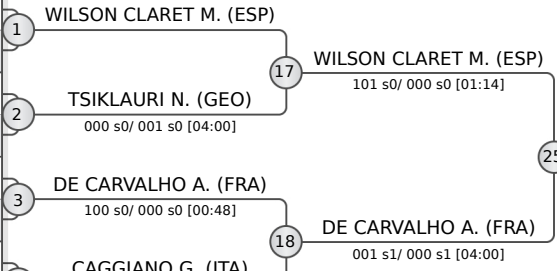

POOL B

	TOMC Nika	SLO
	SHYLOVA Alina	UKR
	HIDEN Verena	AUT
	BREYTENBACH Donne	RSA
	BORTAS Dora	CRO
	GARCIA PONCE Iratxe	ESP
	KOVACS Kitti	HUN

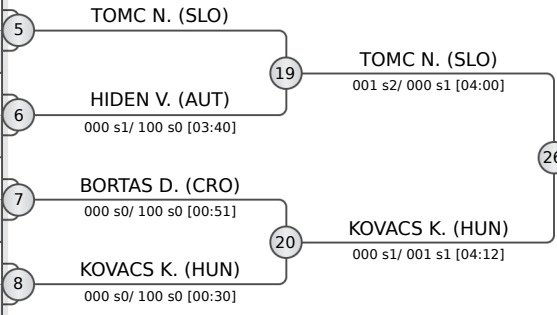

POOL C

	LOLADZE Nino	GEO
	DEGUCHI Kelly	CAN
	NDIAYE Binta	SUI
	GAJIC Jevgenija	SLO
	SHYNKARENKO Inna	UKR
	RODRIGUEZ SALVADOR Adriana	ESP
	JANSSEN Danique	NED

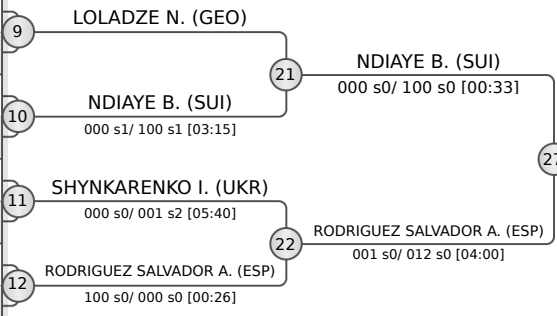

POOL D

	UBASART MASCARO Carla	ESP
	NISAVIC Kristina	SRB
	PELLITTERI Silvia	ITA
	CHYZHEVSKA Anastasiia	UKR
	TARKUS Merit	EST
	VERFAILLIE Luna	BEL
	ABRAHAM Titanilla	HUN

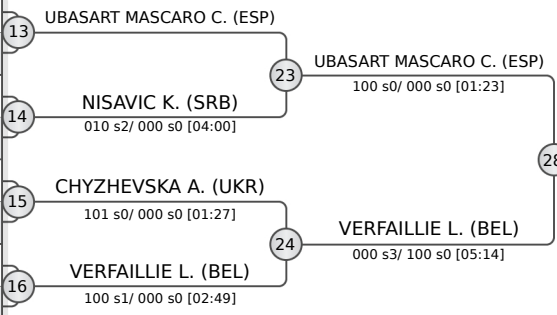

REPECHAGE

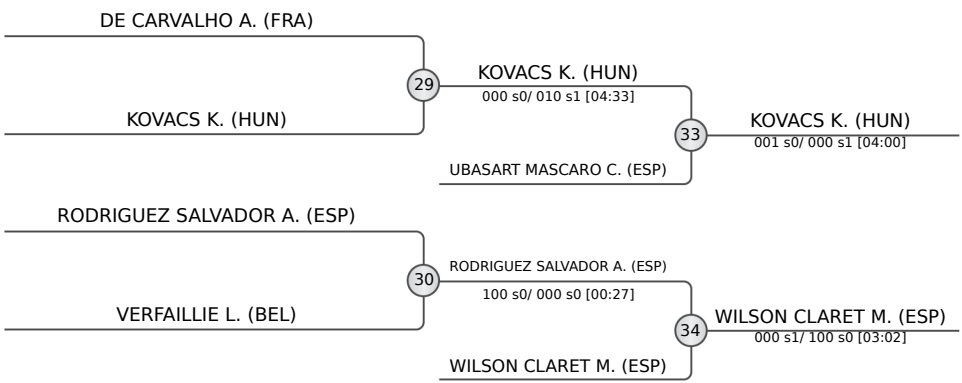

1.	NDIAYE Binta	SUI	
2.	TOMC Nika	SLO	
3.	KOVACS Kitti	HUN	
3.	WILSON CLARET Malin	ESP	
5.	UBASART MASCARO Carla	ESP	
5.	RODRIGUEZ SALVADOR Adriana	ESP	
7.	DE CARVALHO Alya	FRA	
7.	VERFAILLIE Luna	BEL	





Ljubljana European Open 2025

Slovenia, Ljubljana, 8-9 Feb 2025

-63 kg
Seniors (31)

POOL A

	VARGA Brigitta	HUN
	BIRON Laurence	CAN
	GERTSCH Olivia	SUI
	SEDLMAIR Hanna	GER
	TSURKAN Ilariia	UKR
	DANDO Emilie	FRA
	MINKINA Ekaterina	IJF

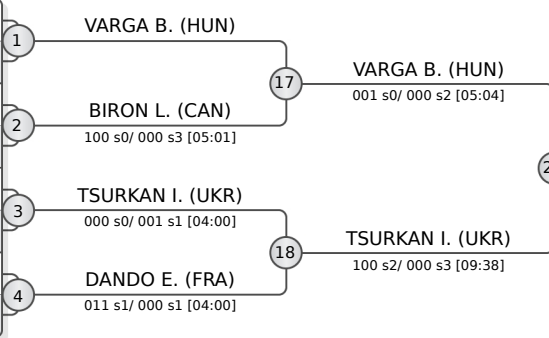

POOL B

	TRETNJAK Lisa	AUT
	LISCIANI Sara	ITA
	BORDINSKYKH Sofia	UKR
	JEFTIC Natasa	MNE
	JASPE Emily Daniela	USA
	STOLZE Friederike	GER
	KAJZER Kaja	SLO
	KOPNYAYEVA Vlada	ESP

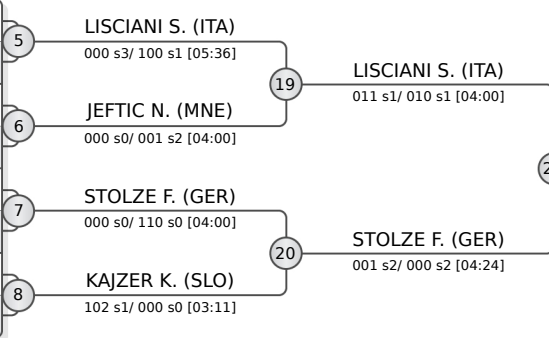

POOL C

	ASKILASHVILI Eter	GEO
	SZAFRAN Agata	POL
	ROSSET Aline	SUI
	NGUYEN Lili	FRA
	CARROUTH Karlee	USA
	NITSCHKE Shenna	GER
	SAMARDZIC Andjela	BIH
	KUCHAVA Iia	UKR

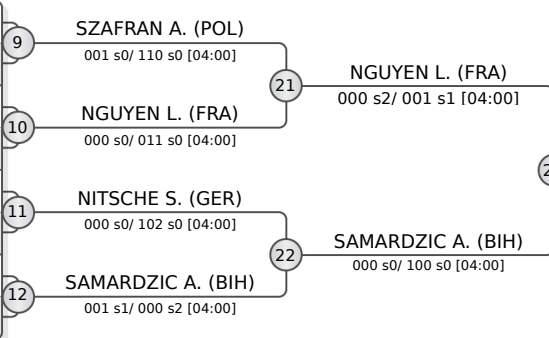

POOL D

	ANTIPINA Anastasiia	UKR
	FRIDEN Chiara	SUI
	MARTINOVIC Mirjana	MNE
	CVJETKO Nina	CRO
	KRIZA Anna	HUN
	MAZOUZI Leila	SLO
	BAUER Bettina	GER
	GRABNER Lisa	AUT

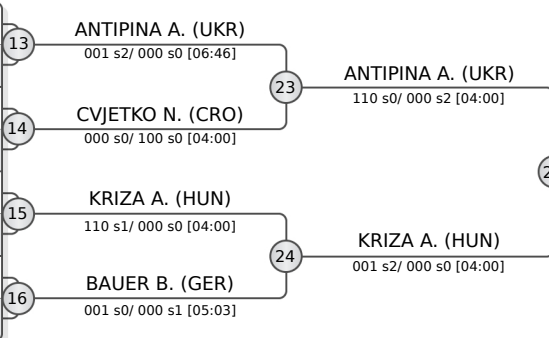

REPECHAGE

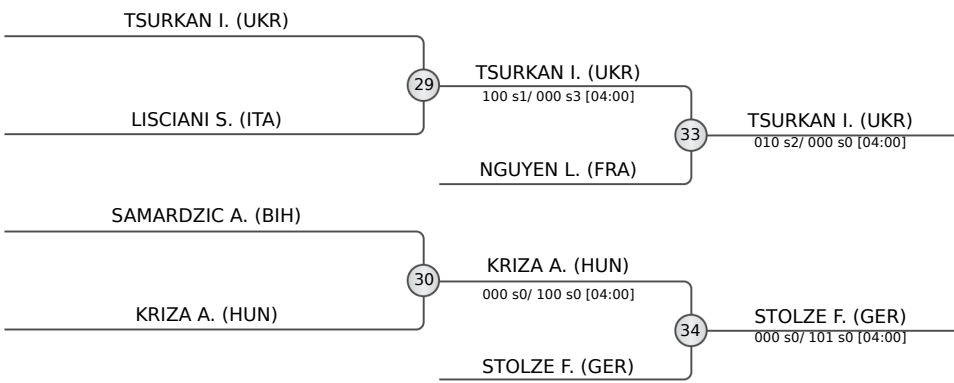

ANTIPINA A. (UKR) 35
000 s1/ 100 s1 [04:00]

ANTIPINA A. (UKR) 32
000 s1/ 021 s0 [04:00]

FINAL RESULTS	
1. ANTIPINA Anastasiia	UKR
2. VARGA Brigitta	HUN
3. TSURKAN Ilariia	UKR
3. STOLZE Friederike	GER
5. NGUYEN Lili	FRA
5. KRIZA Anna	HUN
7. LISCIANI Sara	ITA
7. SAMARDZIC Andjela	BIH





Ljubljana European Open 2025

Slovenia, Ljubljana, 8-9 Feb 2025

-70 kg
Seniors (22)

POOL A

	VIOLIC Andela	CRO
	MEHLAU Sarah	GER
	GONZALEZ Shavon	USA
	TCHANTURIA Mariam	GEO
	FRANZOSI Ludovica	ITA
	ZEMANOVA Vera	CZE

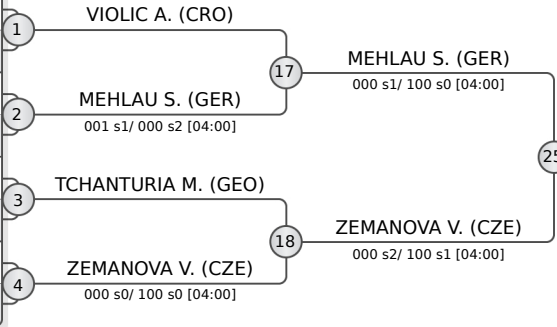

POOL B

	GRAUER Tayla	GER
	MEEUWSEN Lien	BEL
	ZARYBNICKA Julie	CZE
	VETTERLI Gioia	SUI
	VIDENEIEVA Alisa	UKR

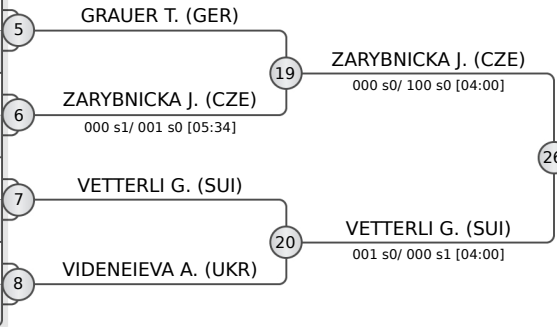

POOL C

	MYERS Melissa	USA
	TSIMKO Olga	UKR
	ZARYBNICKA Lucie	CZE
	MURPHY Bertille	GER
	ZADVORNOVA Ksenia	IJF
	HLADNIK Neza	SLO

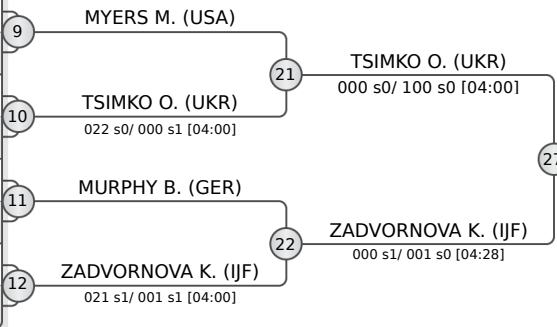

POOL D

	LENGWEILER Alina	SUI
	OLIINYK-KORNIKO Anna	UKR
	NOACK Nele	GER
	CZERLAU Jennifer	HUN
	GARRIGA Isabella	USA

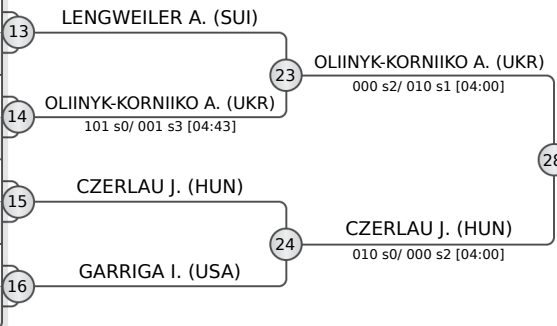

REPECHAGE

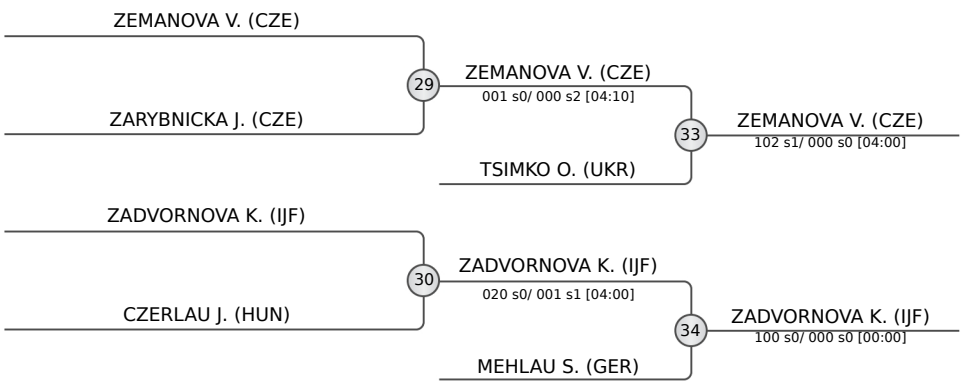

FINAL RESULTS		
1.	VETTERLI Gioia	SUI
2.	OLIINYK-KORNIKO Anna	UKR
3.	ZEMANOVA Vera	CZE
3.	ZADVORNOVA Ksenia	IJF
5.	TSIMKO Olga	UKR
5.	MEHLAU Sarah	GER
7.	ZARYBNICKA Julie	CZE
7.	CZERLAU Jennifer	HUN





Ljubljana European Open 2025

Slovenia, Ljubljana, 8-9 Feb 2025

-78 kg
Seniors (18)

POOL A

	LOBNIK Metka	SLO
	SPEROTTI Claudia	ITA
	PERKOVIC Lorena	CRO
	STJEPANOVIC Jovana	SRB
	BOUSBAA DAB Nisrin	ESP

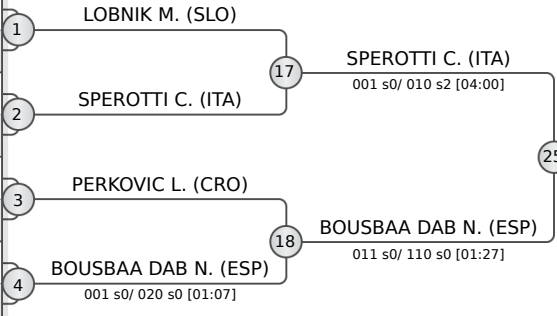

POOL B

	SCHMID Lea	GER
	AMIHAI Shaked	ISR
	KRAPU Emma	FIN
	VUK Betty	ITA

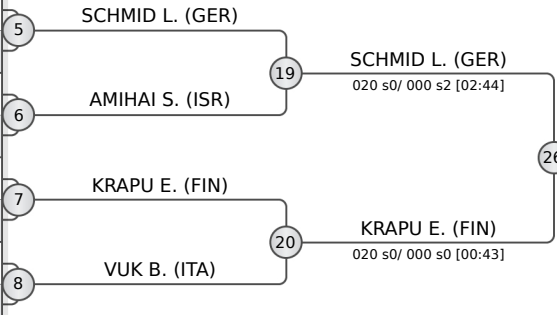

POOL C

	GODBOUT Coralie	CAN
	ISSOUFI Kaila	FRA
	SAGI Nikolett	HUN
	TOCCI Rossana	ITA

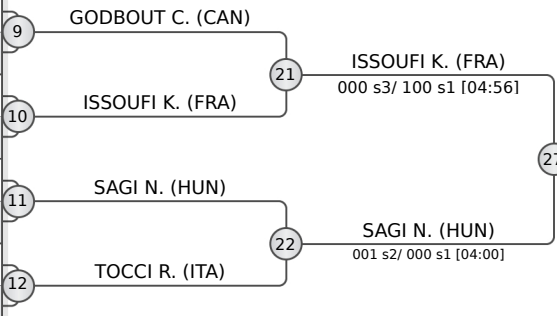

POOL D

	BUDDENKOTTE Eva Ronja	GER
	SCHUSTER Kaja	SLO
	KAZAKOVA Anna	UKR
	CAPONETTO Cinzia	ITA
	SUMMER Laura	AUT

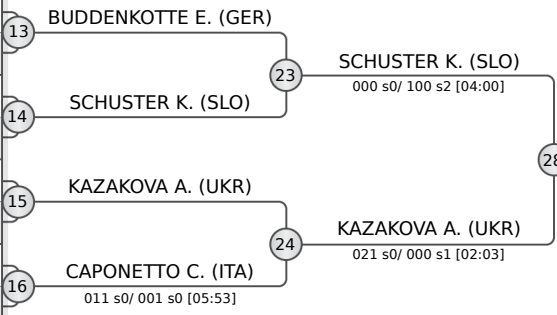

REPECHAGE

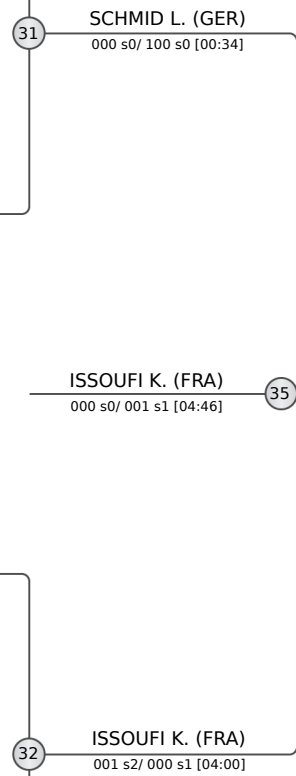
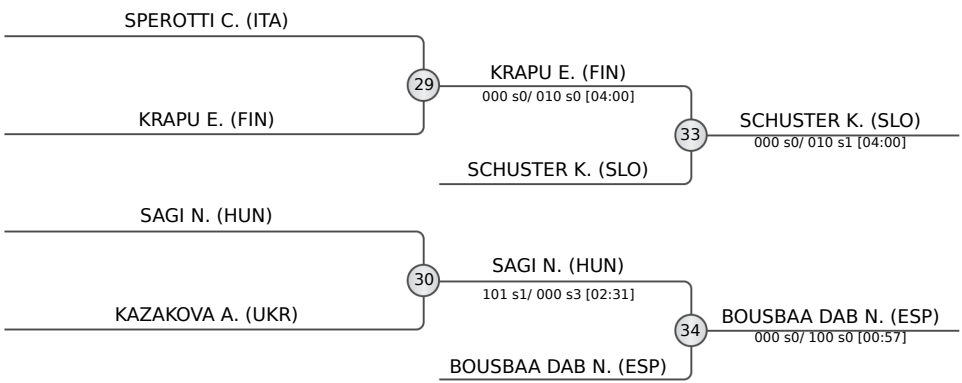

FINAL RESULTS	
1.	ISSOUFI Kaila
2.	SCHMID Lea
3.	SCHUSTER Kaja
3.	BOUSBAA DAB Nisrin
5.	KRAPU Emma
5.	SAGI Nikolett
7.	SPEROTTI Claudia
7.	KAZAKOVA Anna





Ljubljana European Open 2025

Slovenia, Ljubljana, 8-9 Feb 2025

+78 kg
Seniors (13)

POOL A

	SIMONETTI Erica	ITA
	PAPIDZE Nino	GEO
	BOUVIER Gabrielle	BEL

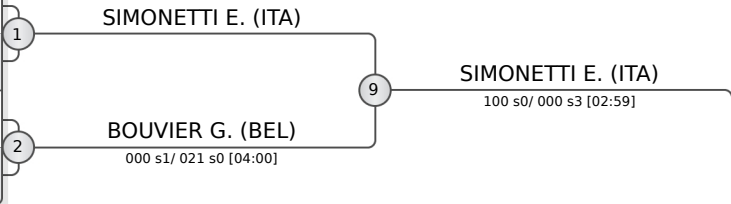

POOL B

	SWEERS Paulien	NED
	LIS Wiktoria	POL
	MARINI Tiziana	ITA
	JANJIC Tara	SLO

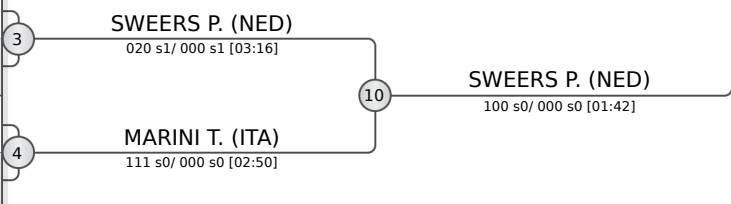

POOL C

	RADIC Tina	CRO
	TORKAR Urska	SLO
	BOGDANOVIC Anastasija	SRB

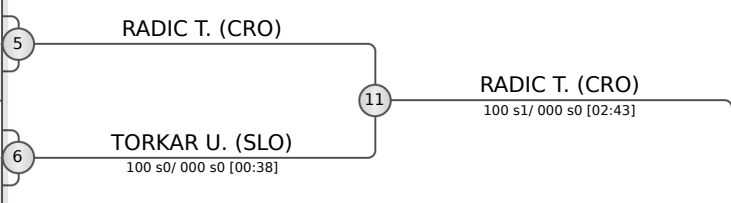

POOL D

	DIJKSTRA Carmen	NED
	GIORDANO Alessia	ITA
	MRVALJEVIC Jovana	MNE

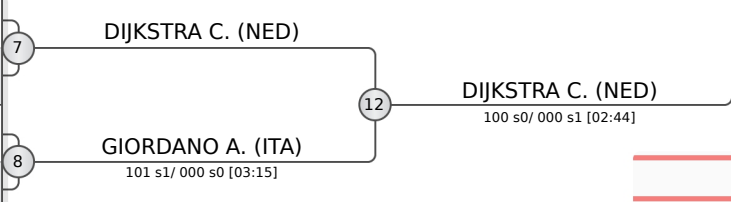

REPECHAGE

BOUVIER G. (BEL)	MARINI T. (ITA)
MARINI T. (ITA)	
TORKAR U. (SLO)	GIORDANO A. (ITA)
GIORDANO A. (ITA)	

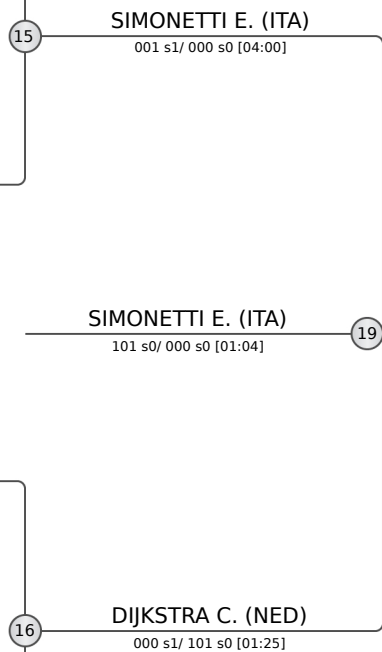
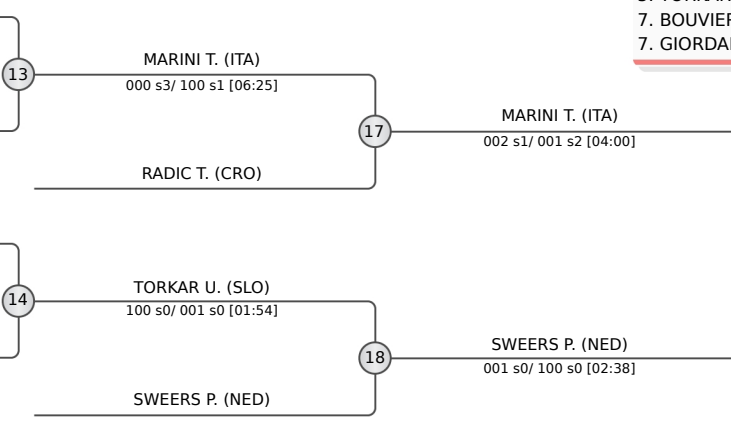

FINAL RESULTS		
1.	SIMONETTI Erica	ITA
2.	DIJKSTRA Carmen	NED
3.	MARINI Tiziana	ITA
3.	SWEERS Paulien	NED
5.	RADIC Tina	CRO
5.	TORKAR Urska	SLO
7.	BOUVIER Gabrielle	BEL
7.	GIORDANO Alessia	ITA

