



# Teplice Millennium Team Cadet European Cup 2025

Czechia, Teplice, 5-6 Apr 2025

## -50 kg

Cadets (30)

POOL A

	CUQ Axel	FRA
	MORO Andrea	ITA
	BAUER Eddie	GER
	CIMBOLAS Timas	LTU
	SANTOS Joao Almeida	POR
	CZINEGE David	HUN
	MARCHIORI Ugo	LUX

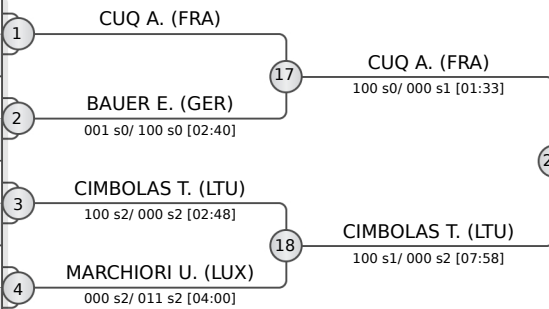

POOL B

	DOBROWOLSKI Bartlomiej	POL
	PORTELLI Leonardo	ITA
	LEMONS RODRIGUEZ Omar	ESP
	JAKL Marek	CZE
	CHIARELLA Luca	ITA
	GUL Ibrahim	TUR
	ZIMMERMANN Felix	GER
	STETS Kiril	UKR

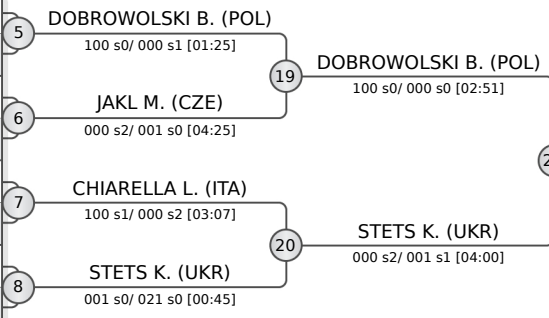

POOL C

	AVRAMOVIC Boban	SRB
	PAK Albert	POL
	KURGANS Edgars	LAT
	GULUA Aleks	GEO
	MEHABRA Ismael	ITA
	CONSTANTINIDES Angelos	CYP
	MARCHUK Serhii	UKR

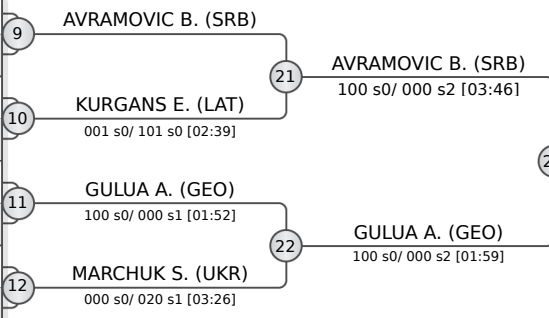

POOL D

	GULIYEV Anar	AZE
	VILLA Tim	FRA
	DOUINE Matteo	ITA
	PALKO Daniel	SVK
	TALIBOV Ibrahim	AZE
	COLAK Ismail	AUT
	KITAGAWA Julius	GER
	HUNTER Luke	GBR

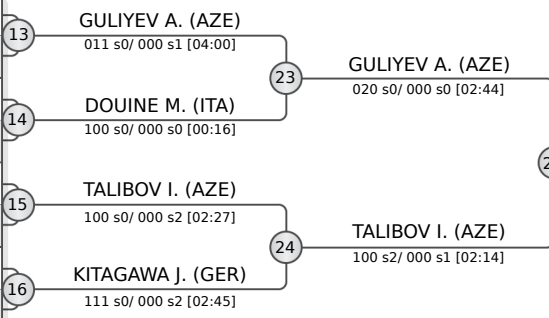

REPECHAGE

BAUER E. (GER) 29	BAUER E. (GER)
PORTELLI L. (ITA) 30	JAKL M. (CZE) 000 s3/ 100 s1 [05:22]
MEHABRA I. (ITA) 31	MEHABRA I. (ITA) 001 s0/ 000 s2 [04:16]
VILLA T. (FRA) 32	VILLA T. (FRA) 100 s0/ 000 s0 [01:03]
DOUINE M. (ITA) 32	TALIBOV I. (AZE) 001 s0/ 011 s1 [04:00]

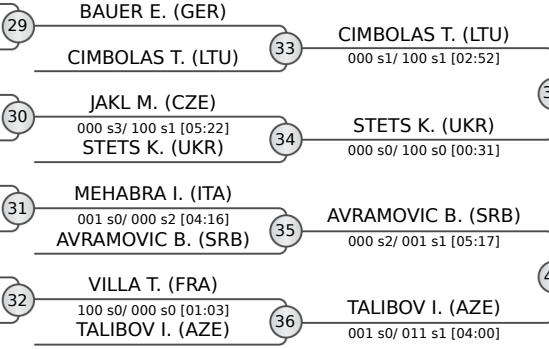

FINAL RESULTS	
1.	GULUA Aleks
2.	CUQ Axel
3.	GULIYEV Anar
3.	DOBROWOLSKI Bartlomiej
5.	STETS Kiril
5.	TALIBOV Ibrahim
7.	CIMBOLAS Timas
7.	AVRAMOVIC Boban

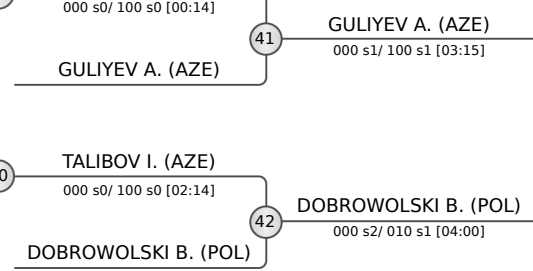



# Teplice Millennium Team Cadet European Cup 2025

Czechia, Teplice, 5-6 Apr 2025

## -55 kg

Cadets (60)

POOL A

1	BUTUCI Kristian (CRO)	1	BUTUCI K. (CRO)
2	GUR Ramazan Aykut (TUR)	33	GUR R. (TUR)
3	CERVINSKIS Bogdanas (LAT)	34	CERVINSKIS B. (LAT)
4	ALIZADA Rasul (AZE)	35	ALIZADA R. (AZE)
5	MARKOVICS Andrej (SVK)	36	MARKOVICS A. (SVK)
6	FRANZ Leonard (GER)	37	FRANZ L. (GER)
7	ALEKSEJUNAS Natas (LTU)	38	ALEKSEJUNAS N. (LTU)
8	WENCEL Jakub (POL)	39	WENCEL J. (POL)
9	KURBANOV Djamil (AUT)	40	KURBANOV D. (AUT)
10	MARINO Vincenzo (ITA)	41	MARINO V. (ITA)
11	MAINGOT Victor (FRA)	42	MAINGOT V. (FRA)

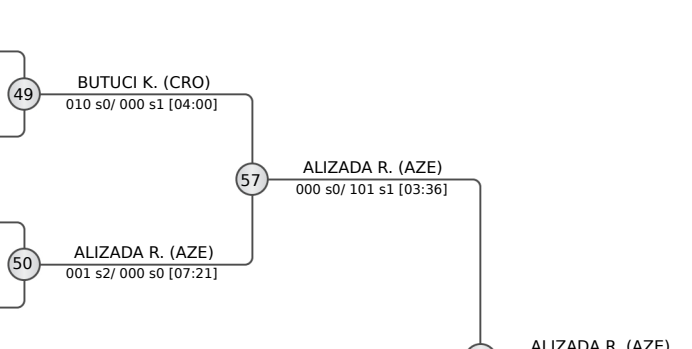

POOL B

9	CORI Silvano (SUI)	9	CORI S. (SUI)
10	SORICI Alin Marian (ROU)	37	SORICI A. (ROU)
11	RAMAZZOTTO Giulio (ITA)	38	RAMAZZOTTO G. (ITA)
12	ZVORC Jona (CRO)	39	ZVORC J. (CRO)
13	BULINGER Daniel (GER)	40	BULINGER D. (GER)
14	CZALBOWSKI Szymon (POL)	41	CZALBOWSKI S. (POL)
15	SPINU Arsenijs (LAT)	42	SPINU A. (LAT)
16	GUALANDI Matteo (ITA)	43	GUALANDI M. (ITA)
17	KOSTOEV Adam (SWE)	44	KOSTOEV A. (SWE)
18	MARKOVIC Petar (SRB)	45	MARKOVIC P. (SRB)
19	HONTIUK Roman (UKR)	46	HONTIUK R. (UKR)
20	SETROREDJO Levy (NED)	47	SETROREDJO L. (NED)
21	PETSCHALLIES Noah (GER)	48	PETSCHALLIES N. (GER)
22	WOJNA Dawid (POL)	49	WOJNA D. (POL)
23	SIMON Yonatan (ISR)	50	SIMON Y. (ISR)

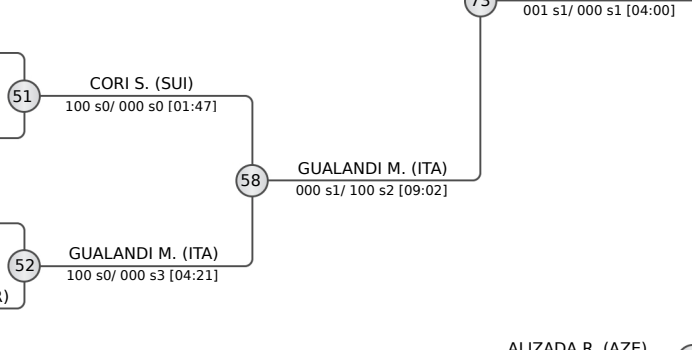

POOL C

17	JAKUBAUSKAS Adris (LTU)	17	JAKUBAUSKAS A. (LTU)
18	FUCHS Yuval (ISR)	41	FUCHS Y. (ISR)
19	ORNİK Yann (AUT)	42	ORNİK Y. (AUT)
20	SIENKIEWICZ Ryszard (POL)	43	SIENKIEWICZ R. (POL)
21	LUCIC Sime (CRO)	44	LUCIC S. (CRO)
22	GIVANNI Natan (ITA)	45	GIVANNI N. (ITA)
23	OESTERWIND Max (GER)	46	OESTERWIND M. (GER)
24	ZINCHUK Maksym (UKR)	47	ZINCHUK M. (UKR)
25	PETROVIC Nikola (SRB)	48	PETROVIC N. (SRB)
26	FEST Benedikt (GER)	49	FEST B. (GER)
27	UYAR Celil (NED)	50	UYAR C. (NED)
28	PIPAN Tim (SLO)	51	PIPAN T. (SLO)
29	EBNETER Ramon (SUI)	52	EBNETER R. (SUI)
30	KOLOSSOV Kristo (EST)	53	KOLOSSOV K. (EST)
31	RUCINSKI-ZAJAC Antoni (POL)	54	RUCINSKI-ZAJAC A. (POL)

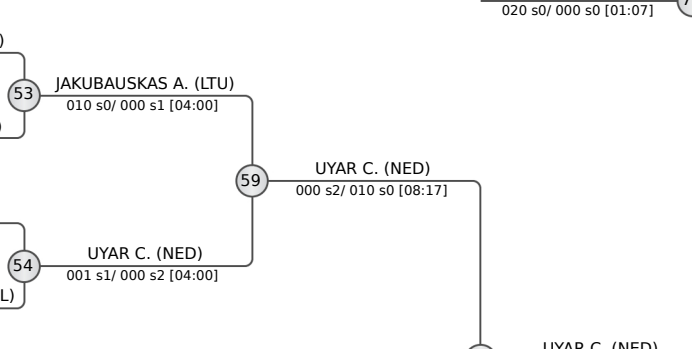

POOL D

25	LUCAS Titouan (FRA)	25	LUCAS T. (FRA)
26	TATARYN Nikita (UKR)	45	TATARYN N. (UKR)
27	GLENSKI Jakob (POL)	46	GLENSKI J. (POL)
28	HERMANN Leon (GER)	47	HERMANN L. (GER)
29	KATS Matvii (CZE)	48	KATS M. (CZE)
30	DAMM Oliver (HUN)	49	DAMM O. (HUN)
31	FRANZESE Francesco (ITA)	50	FRANZESE F. (ITA)
32	HUSIYEV Mahammadali (AZE)	51	HUSIYEV M. (AZE)
33	GHIDONI Thomas (ITA)	52	GHIDONI T. (ITA)
34	LOPEZ Ian (AND)	53	LOPEZ I. (AND)
35	LACIKA Silvio (SVK)	54	LACIKA S. (SVK)
36	MONTEIRO Davi (POR)	55	MONTEIRO D. (POR)
37	KUIPERS John Vincent (NED)	56	KUIPERS J. (NED)
38	SAULITE Toms (LAT)	57	SAULITE T. (LAT)
39	SCHUMANN Janek Paul (GER)	58	SCHUMANN J. (GER)

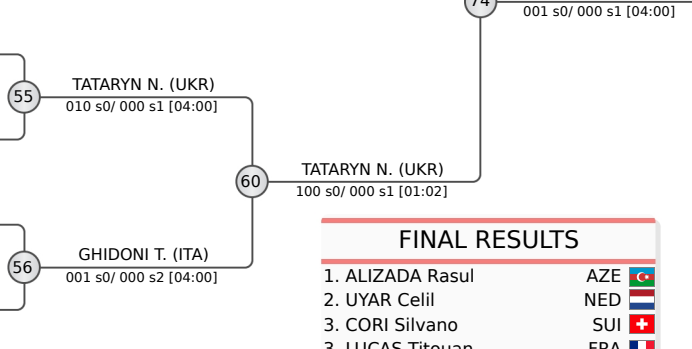

REPECHAGE

61	MARKOVICS A. (SVK)	61	MARKOVICS A. (SVK)
62	ALEKSEJUNAS N. (LTU)	62	ALEKSEJUNAS N. (LTU)
63	KOSTOEV A. (SWE)	63	KOSTOEV A. (SWE)
64	HONTIUK R. (UKR)	64	HONTIUK R. (UKR)
65	FEST B. (GER)	65	FEST B. (GER)
66	ZINCHUK M. (UKR)	66	ZINCHUK M. (UKR)
67	GLENSKI J. (POL)	67	GLENSKI J. (POL)
68	LUCAS T. (FRA)	68	LUCAS T. (FRA)

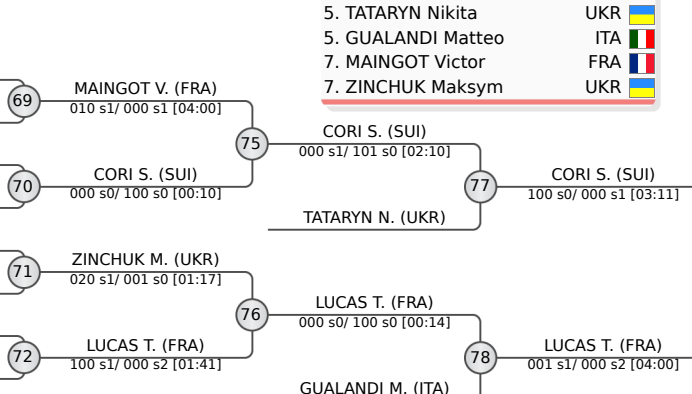

FINAL RESULTS	
1.	ALIZADA Rasul (AZE)
2.	UYAR Celil (NED)
3.	CORI Silvano (SUI)
3.	LUCAS Titouan (FRA)
5.	TATARYN Nikita (UKR)
5.	GUALANDI Matteo (ITA)
7.	MAINGOT Victor (FRA)
7.	ZINCHUK Maksym (UKR)



# Teplice Millennium Team Cadet European Cup 2025

Czechia, Teplice, 5-6 Apr 2025

## -60 kg

Cadets (71)

POOL A

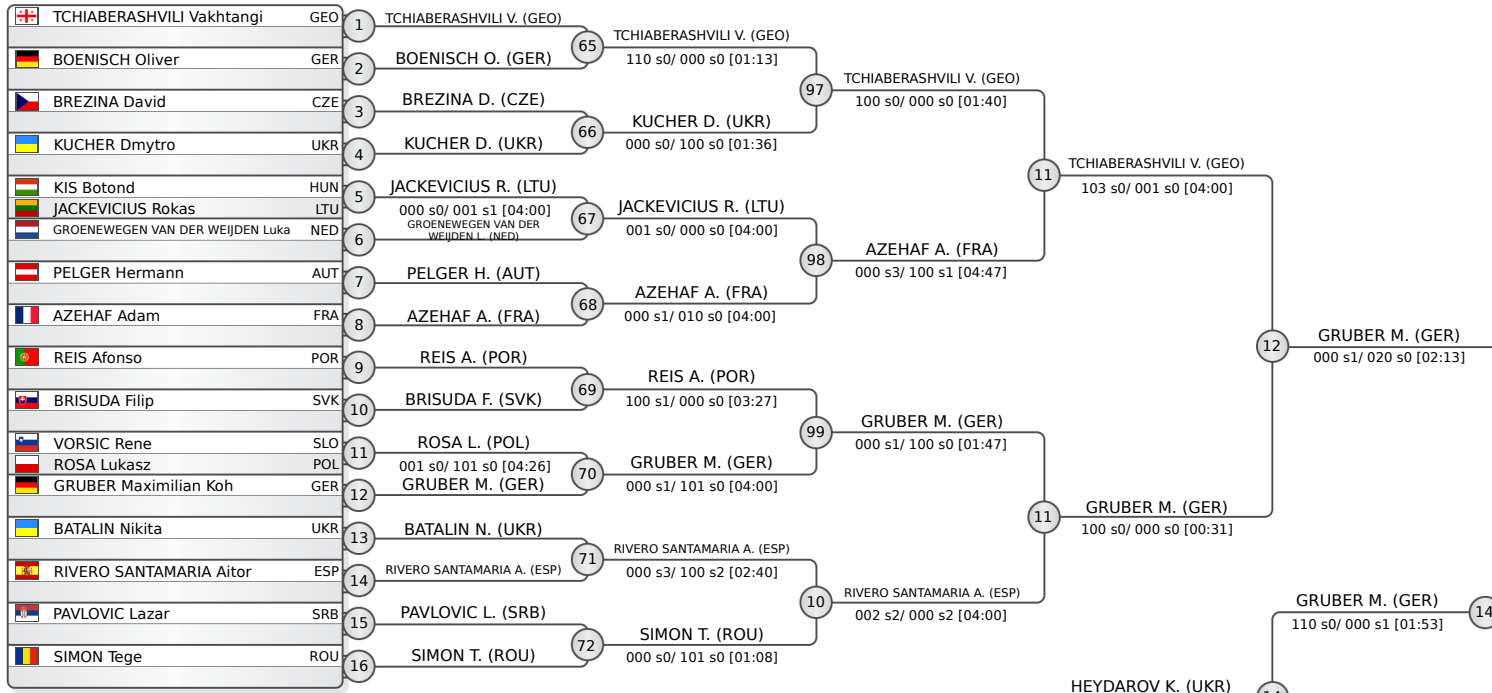

POOL B

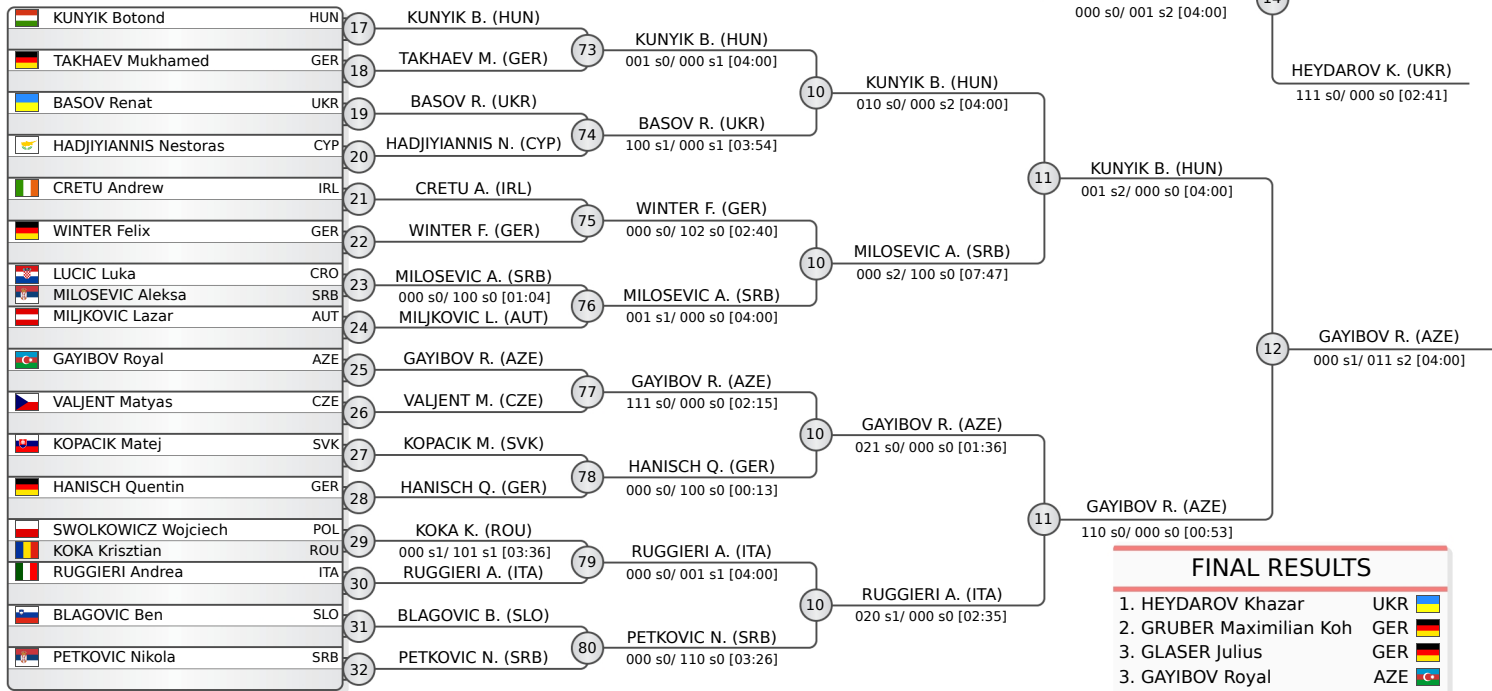

1.	HEYDAROV Khazar	UKR
2.	GRUBER Maximilian Koh	GER
3.	GLASER Julius	GER
3.	GAYIBOV Royal	AZE
5.	KUNYIK Botond	HUN
5.	ESENOGA Can Emirhan	TUR
7.	TCHIBERASHVILI Vakhtangi	GEO
7.	SCHRODL Kornel	HUN

REPECHAGE

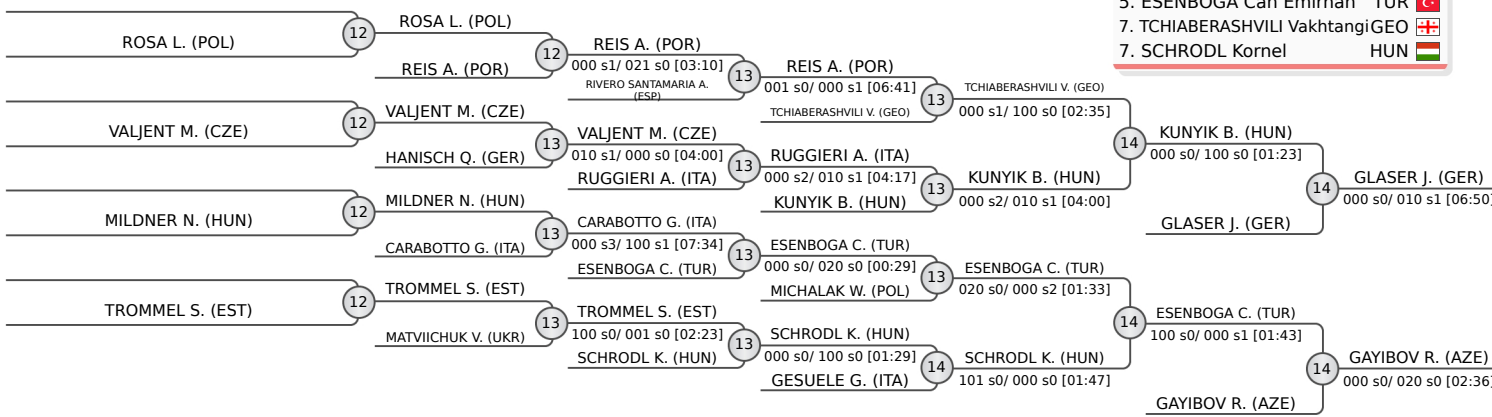



# Teplice Millennium Team Cadet European Cup 2025

Czechia, Teplice, 5-6 Apr 2025

## -60 kg

Cadets (71)

POOL C

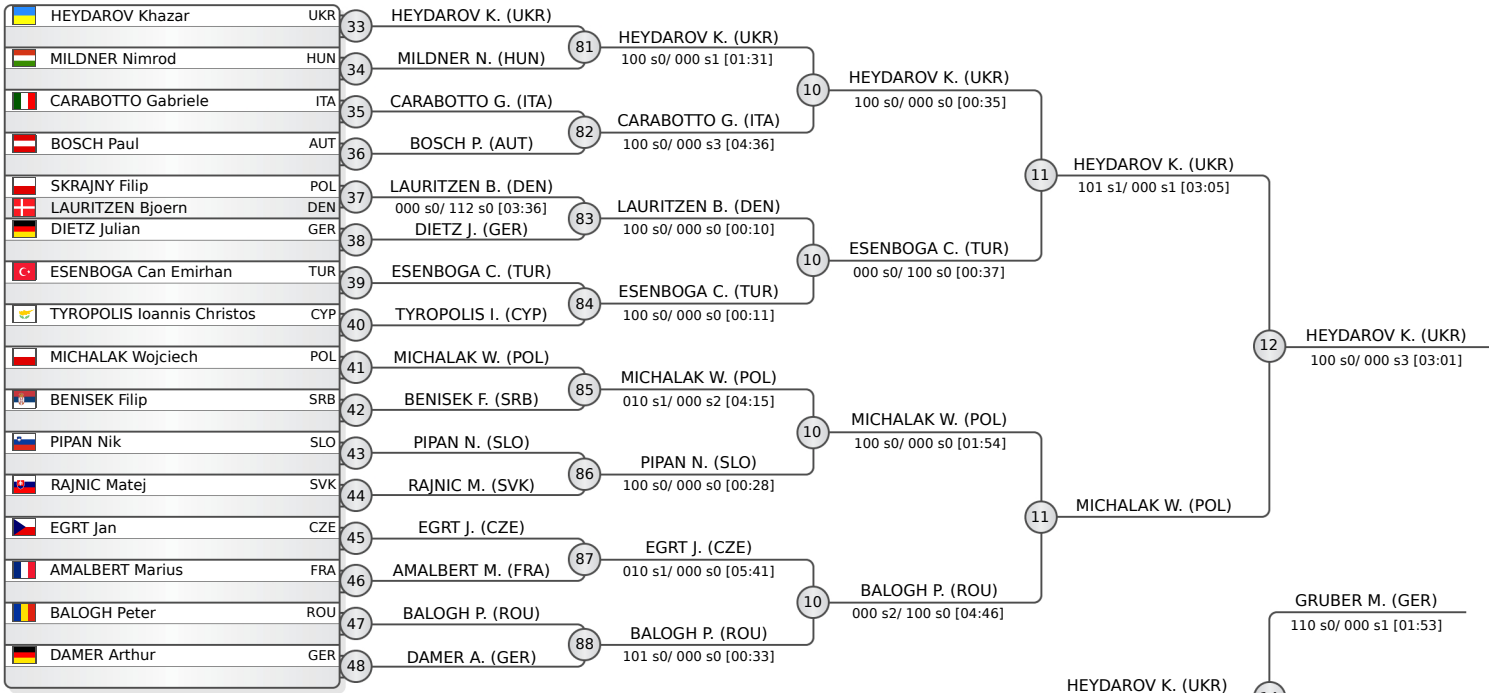

POOL D

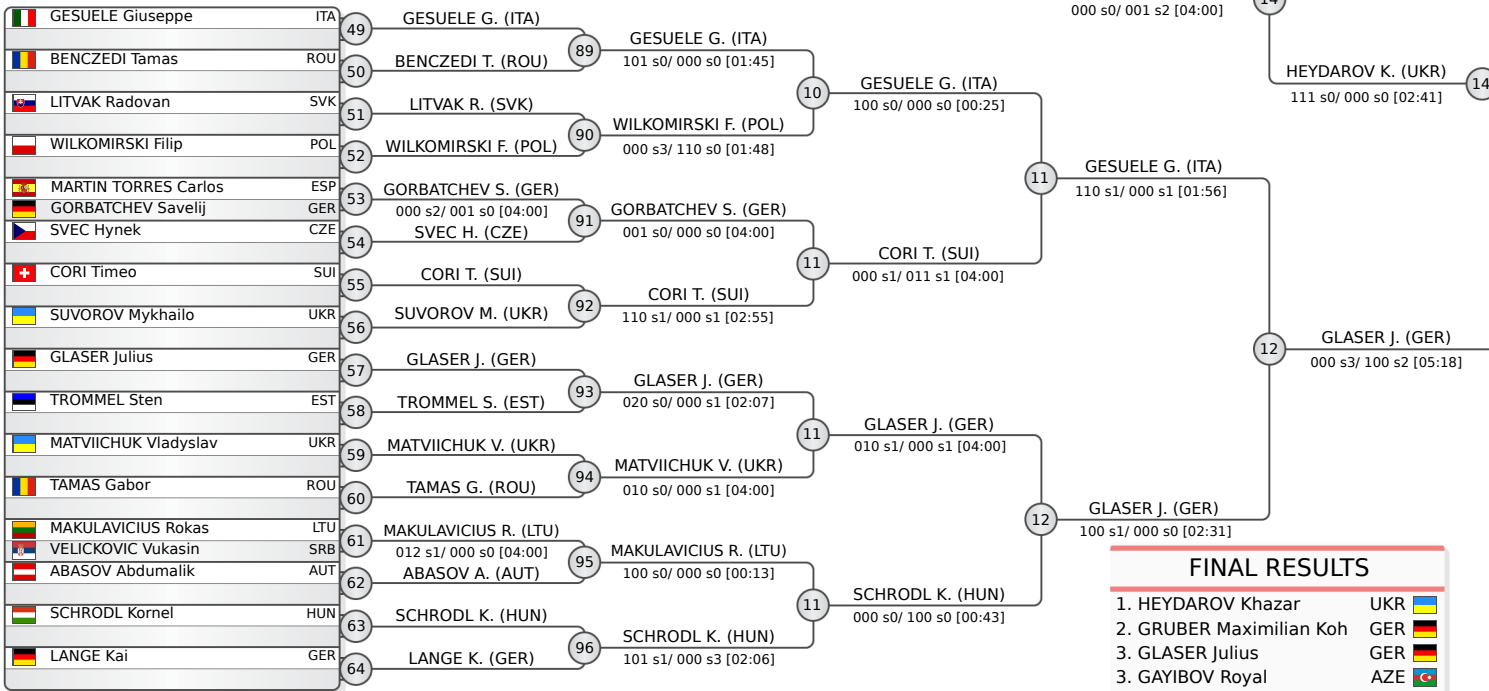

FINAL RESULTS		
1.	HEYDAROV Khazar	UKR
2.	GRUBER Maximilian Koh	GER
3.	GLASER Julius	GER
3.	GAYBOV Royal	AZE
5.	KUNYIK Botond	HUN
5.	ESEBBOGA Can Emirhan	TUR
7.	TCHIBERASHVILI Vakhtangi	GEO
7.	SCHRODL Kornel	HUN

REPECHAGE

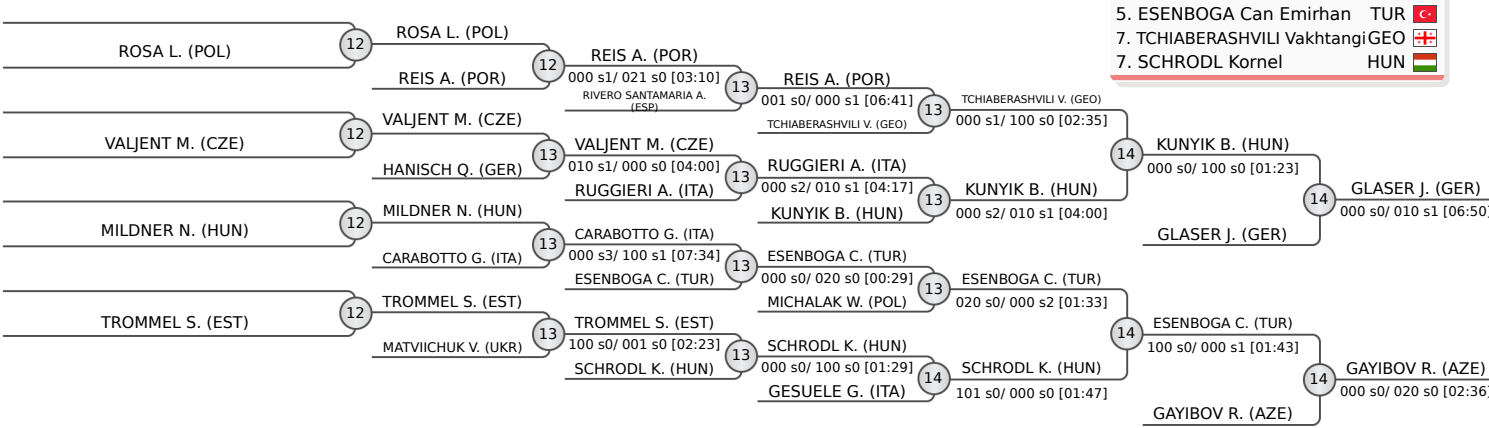



# Teplice Millennium Team Cadet European Cup 2025

Czechia, Teplice, 5-6 Apr 2025

## -66 kg

Cadets (95)

### POOL A

	NAZARENKO Illia	UKR
	BURTSCHER Philipp	AUT
	RUPPRICH Albert	GER
	LE DUC Tri	CZE
	GIANNONE Stefano	ITA
	TODOROVIC Ivan	CRO
	LAFORGE Yann	FRA
	KAPUSNIAK Kacper	POL
	KURGHINYAN Misha	NED
	SCHUERER Hannes	GER
	GAL Kristof	HUN
	MILOSIC Lan	SLO
	HOMKA Eriks	LAT
	JANUSIS Zygimantas	LTU
	TSCHERHEIKO Malik	GER
	PAIVA Nuno	POR
	ONAY Numan	TUR
	LIBRA Marek	CZE
	WROBEL Tomasz	POL
	BEZPALENKO Davyd	AUT
	HRYNKO Bohdan	UKR
	PAVLOVIC Luka	SRB
	ERCOLI Alessandro	ITA
	HARUTA Ion	GER

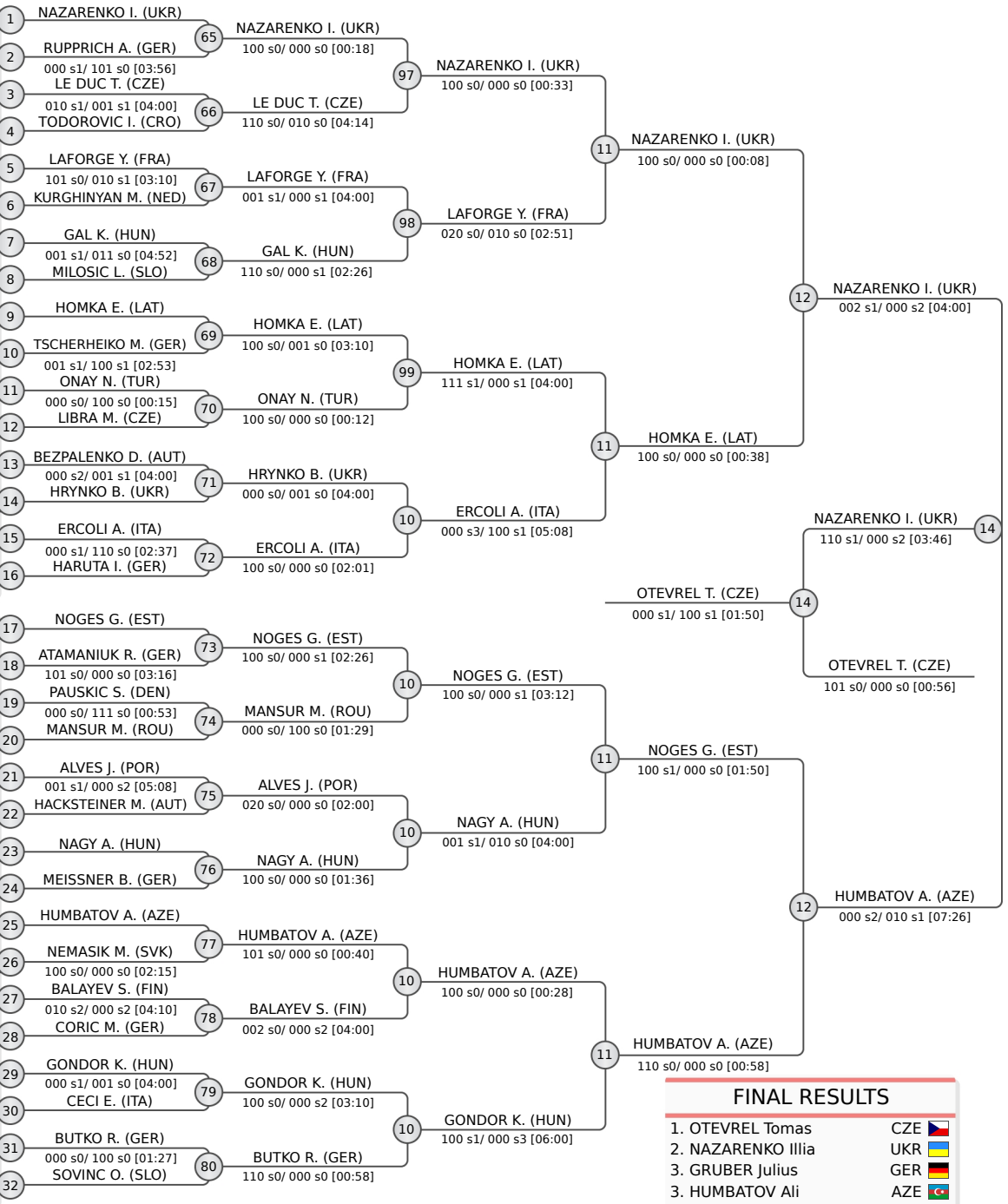

### POOL B

	NOGES Georg	EST
	ATAMANIUK Rostyslav	GER
	WATOLA Mateusz	POL
	MOUSIKOS Nikolas	CYP
	PAUSKIC Silas	DEN
	MANSUR Marwan	ROU
	ALVES Joao Tiago	POR
	SERAFINI Christian	ITA
	HACKSTEINER Michael	AUT
	NAGY Aron	HUN
	MEISSNER Barnabas	GER
	HUMBATOV Ali	AZE
	NEMASIK Matej	SVK
	KILADZE Lazare	GER
	BALAYEV Samir	FIN
	PRICHYSTAL Leon	CZE
	CORIC Martino	GER
	SEMENOVYCH Orest	UKR
	GONDOR Kristof	HUN
	CECI Emiliano	ITA
	MIS Karol	POL
	BUTKO Ruslan	GER
	SOVINC Ozbej	SLO

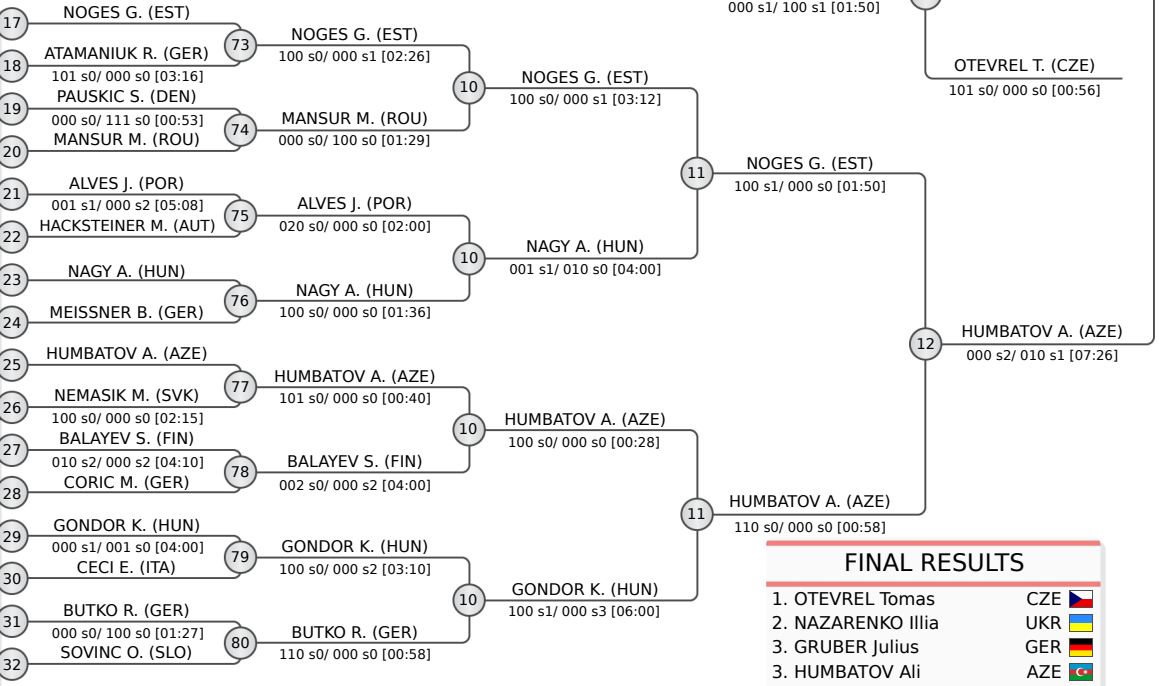

FINAL RESULTS		
1.	OTEVREL Tomas	CZE
2.	NAZARENKO Illia	UKR
3.	GRUBER Julius	GER
3.	HUMBATOV Ali	AZE
5.	NOGES Georg	EST
5.	OSTAPENKO Bohdan	UKR
7.	HOMKA Eriks	LAT
7.	GULIYEV Ozgan	AZE

### REPECHAGE

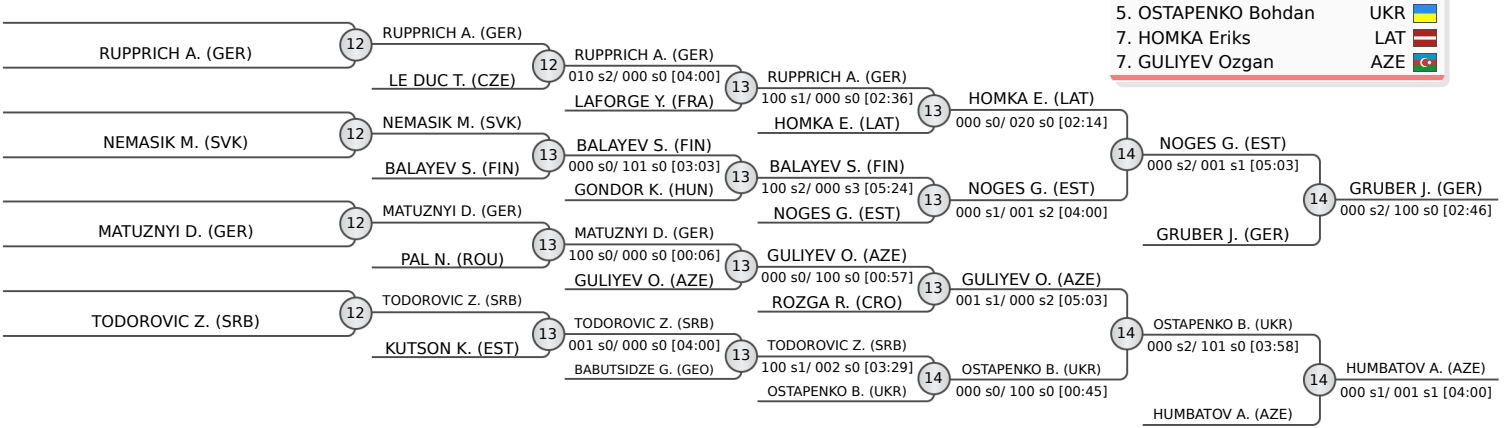



# Teplice Millennium Team Cadet European Cup 2025

Czechia, Teplice, 5-6 Apr 2025

## -66 kg

Cadets (95)

POOL C

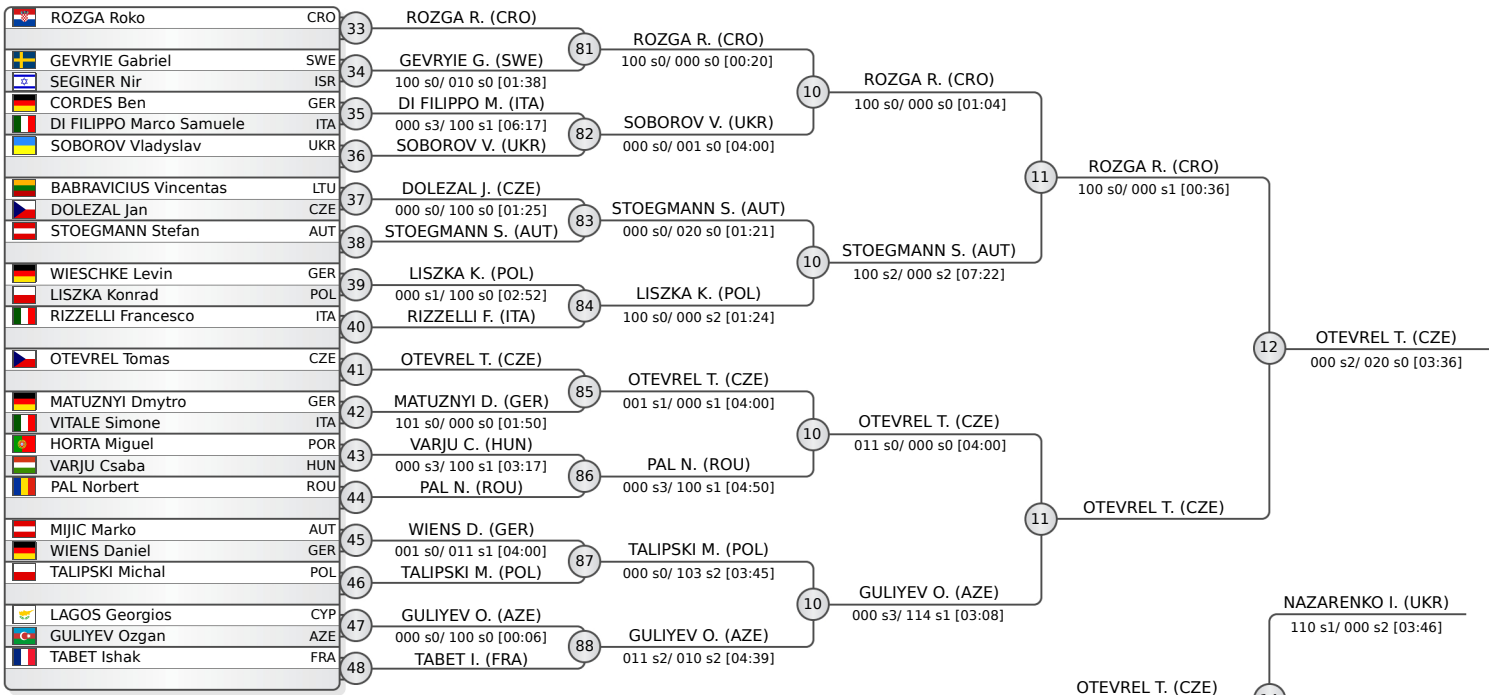

POOL D

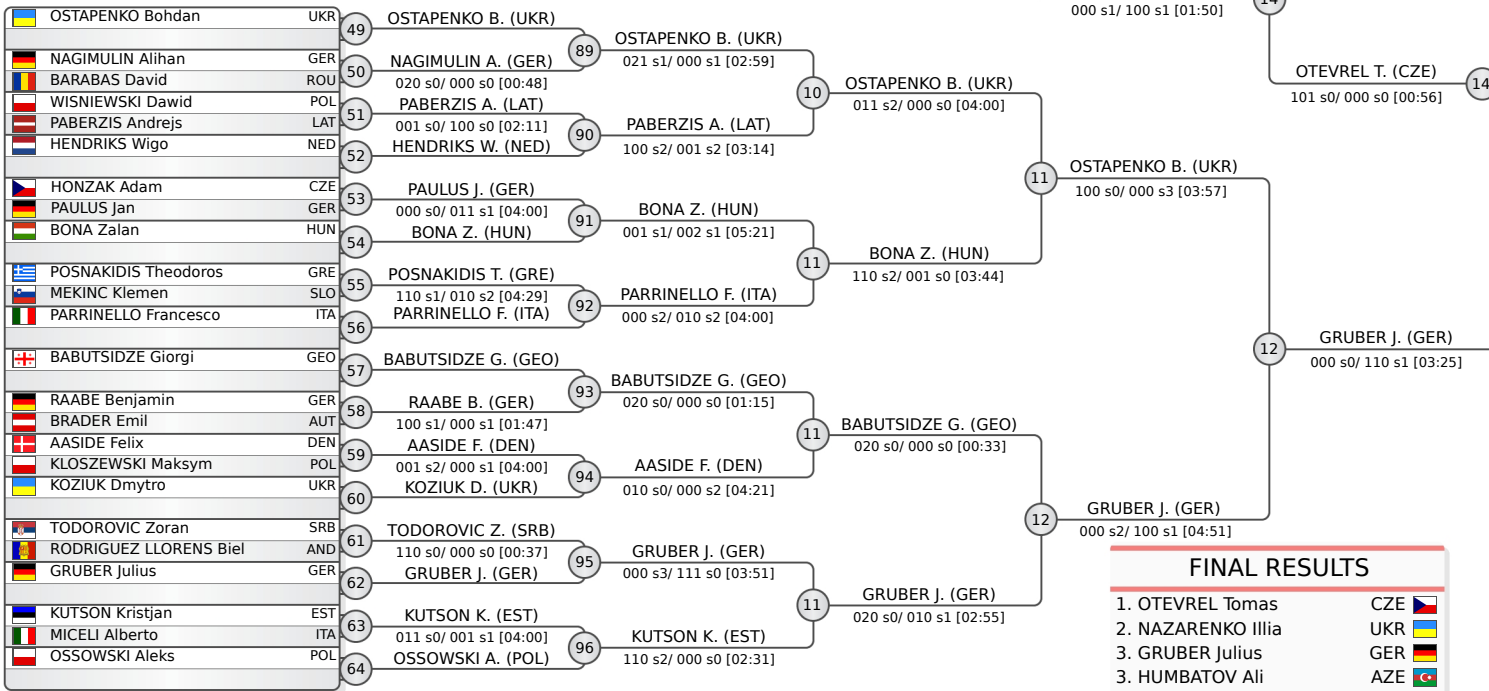

REPECHAGE

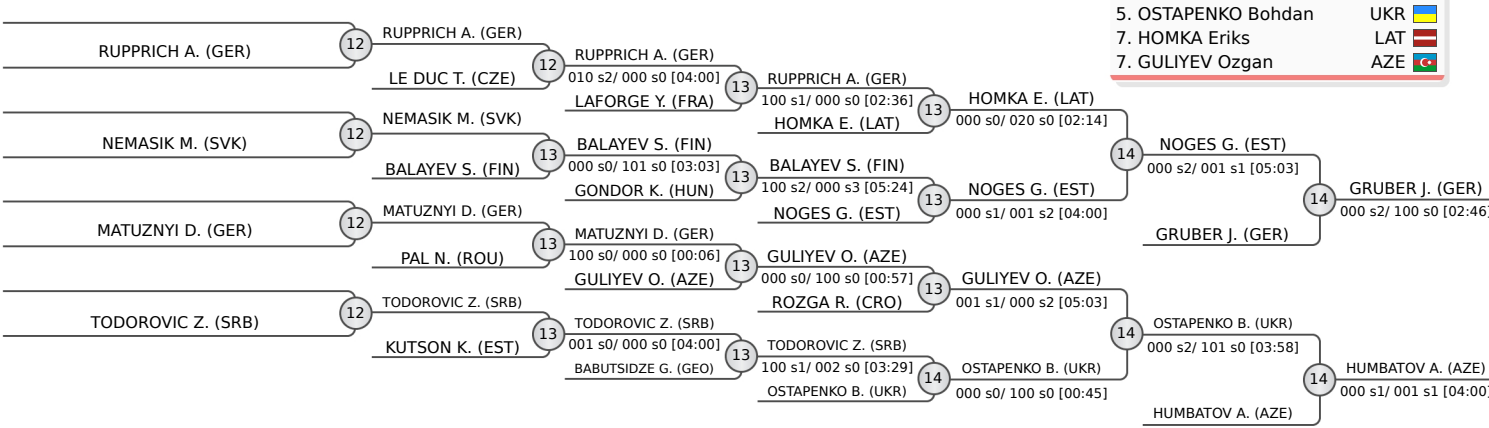

FINAL RESULTS		
1.	OTEVREL Tomas	CZE 🇨🇪
2.	NAZARENKO Illia	UKR 🇺🇦
3.	GRUBER Julius	GER 🇩🇪
3.	HUMBATOV Ali	AZE 🇦🇿
5.	NOGES Georg	EST 🇪🇸
5.	OSTAPENKO Bohdan	UKR 🇺🇦
7.	HOMKA Eriks	LAT 🇱🇻
7.	GULIYEV Ozgan	AZE 🇦🇿



# Teplice Millennium Team Cadet European Cup 2025

Czechia, Teplice, 5-6 Apr 2025

## -73 kg

### Cadets (80)

#### POOL A

	MILJIC Sinisa	SRB	1	MILJIC S. (SRB)
	SCHUMACHER Till	GER	2	SCHUMACHER T. (GER)
	HAMDAOUI Ahmed-Adam	FRA	3	HAMDAOUI A. (FRA)
	BRIGGER Ian	SUI	002 s0/ 001 s1 [04:50]	HAMDAOUI A. (FRA)
	HOLOVANOV Kyrylo	POL	4	HOLOVANOV K. (POL)
	WIEDERHOLD Jonathan	GER	5	WIEDERHOLD J. (GER)
	MAKSIMOVIC Vuk	BIH	001 s1/ 000 s0 [04:32]	WIEDERHOLD J. (GER)
	KHARCHENKO Mykyta	UKR	6	KHARCHENKO M. (UKR)
	SPO LJARIC Lovro	CRO	7	SPO LJARIC L. (CRO)
	LANTOS Levente	HUN	8	LANTOS L. (HUN)
	RUSNAK Adam	CZE	9	RUSNAK A. (CZE)
	TOMAS Michal	SVK	10	TOMAS M. (SVK)
	TEMNIKER Taj	SLO	011 s1/ 000 s2 [04:00]	RUSNAK A. (CZE)
	AGHAKISHIYEV Mahammad	AZE	11	AGHAKISHIYEV M. (AZE)
	PIKTEL Maksymilian	POL	12	PIKTEL M. (POL)
	DIRR Joe	AUT	13	GONSCHOREK P. (GER)
	GONSCHOREK Philipp	GER	14	PEHRSON L. (SWE)
	PEHRSON Leo	SWE	15	PEHRSON L. (SWE)
	STINER Noam	ISR	16	STINER N. (ISR)
	CERNIAVSKIJ Kiril	LTU	17	CERNIAVSKIJ K. (LTU)

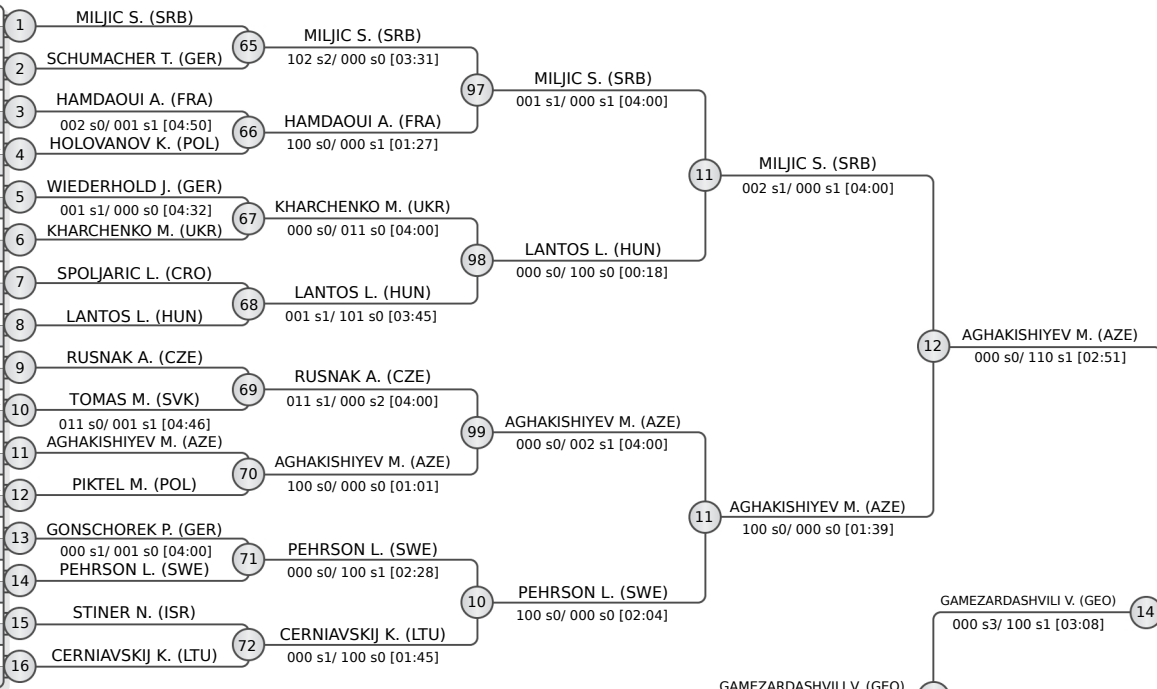

#### POOL B

	GAMEZARDASHVILI Vasil	GEO	17	GAMEZARDASHVILI V. (GEO)
	ZAK Adam	CZE	18	ZAK A. (CZE)
	TERJEK Temes	HUN	021 s0/ 000 s0 [03:20]	GAMEZARDASHVILI V. (GEO)
	TERESHONKOV Oleh	UKR	19	TERESHONKOV O. (UKR)
	DISTEL Roman	GER	20	DISTEL R. (GER)
	RZEMIENIECKI Filip	POL	21	RZEMIENIECKI F. (POL)
	POHLMANN Willi-Balduin	GER	22	POHLMANN W. (GER)
	KARALEVICIUS Zygimantas	LTU	23	KARALEVICIUS Z. (LTU)
	COMITTI Simone	ITA	001 s0/ 000 s2 [04:00]	STARING E. (NED)
	STARING Eros	NED	24	STARING E. (NED)
	SHARIFOV Said	AZE	25	SHARIFOV S. (AZE)
	ZBYTNIIEWSKI Aleksander	POL	26	ZBYTNIIEWSKI A. (POL)
	DJURISIC Balsa	MNE	27	GIGILASHVILI L. (GBR)
	GIGILASHVILI Luka	GBR	28	ISKENDEROV M. (GER)
	ISKENDEROV Mohammad Ali	GER	29	ISKENDEROV M. (GER)
	MIKONIS Dangiras	LTU	30	MIKONIS D. (LTU)
	TANASJJEVIC Aleksa	SRB	31	ADROVIC L. (SLO)
	ADROVIC Leon	SLO	32	ADROVIC L. (SLO)
	NAIDIUK Volodymyr	UKR	33	NAIDIUK V. (UKR)
	BERG Bert	EST	34	BERG B. (EST)

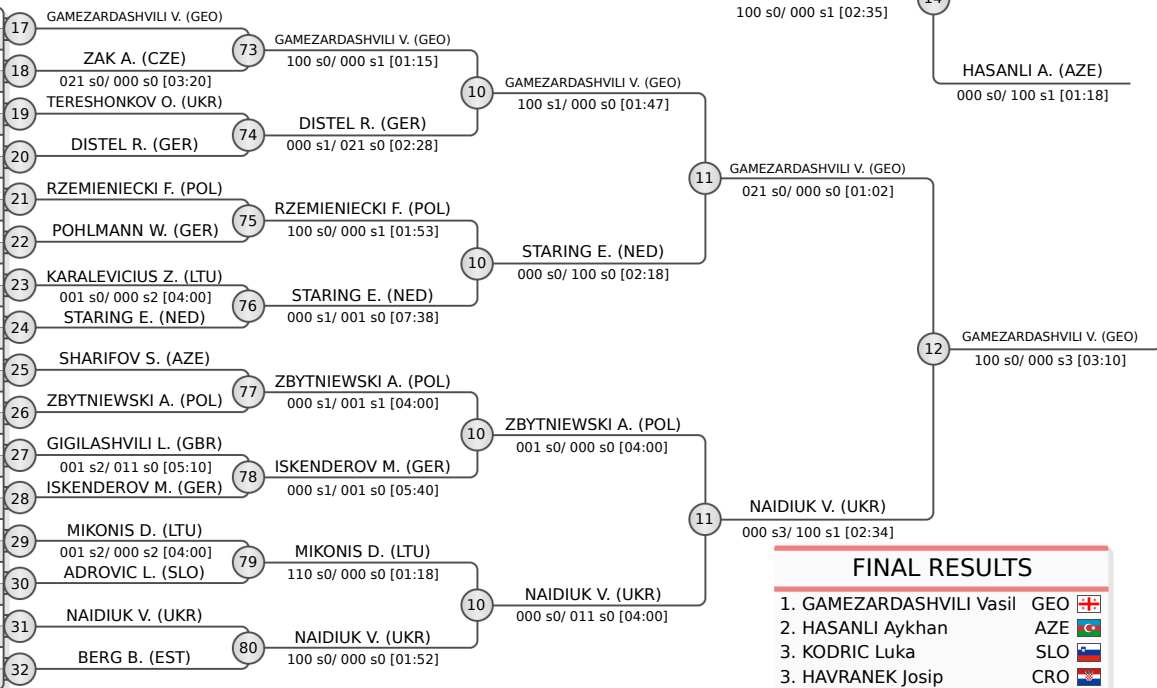

#### REPECHAGE

	PIKTEL M. (POL)	12	PIKTEL M. (POL)
	ZAK A. (CZE)	12	ZAK A. (CZE)
	GOMBKOTO M. (HUN)	12	GOMBKOTO M. (HUN)
	JALIC U. (SRB)	12	JALIC U. (SRB)
	RUSNAK A. (CZE)	13	RUSNAK A. (CZE)
	DISTEL R. (GER)	13	DISTEL R. (GER)
	KATRANIDIS I. (GRE)	13	KATRANIDIS I. (GRE)
	FUNKE T. (GER)	13	FUNKE T. (GER)
	RUSNAK A. (CZE)	13	RUSNAK A. (CZE)
	PEHRSON L. (SWE)	13	PEHRSON L. (SWE)
	DISTEL R. (GER)	13	DISTEL R. (GER)
	STARING E. (NED)	13	STARING E. (NED)
	KATRANIDIS I. (GRE)	13	KATRANIDIS I. (GRE)
	HAIJIYEV A. (SWE)	13	HAIJIYEV A. (SWE)
	PIVNIUK A. (UKR)	13	PIVNIUK A. (UKR)
	RUSNAK A. (CZE)	13	RUSNAK A. (CZE)
	ADROVIC L. (SLO)	13	ADROVIC L. (SLO)
	NAIDIUK V. (UKR)	13	NAIDIUK V. (UKR)
	KRIVOLAPOV E. (KGZ)	13	KRIVOLAPOV E. (KGZ)
	PIVNIUK A. (UKR)	13	PIVNIUK A. (UKR)
	HAVRANEK J. (CRO)	13	HAVRANEK J. (CRO)
	HAVRANEK J. (CRO)	14	HAVRANEK J. (CRO)
	AGHAKISHIYEV M. (AZE)	14	AGHAKISHIYEV M. (AZE)

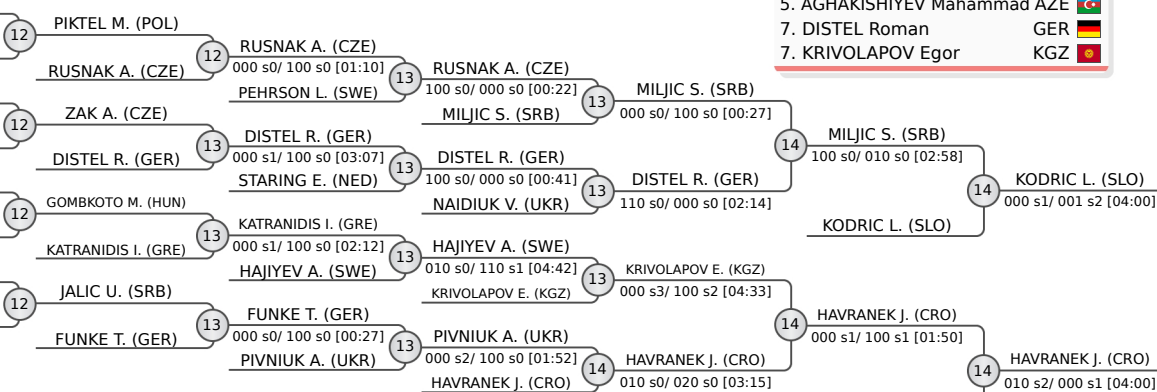

FINAL RESULTS		
1.	GAMEZARDASHVILI Vasil	GEO
2.	HASANLI Aykhan	AZE
3.	KODRIC Luka	SLO
3.	HAVRANEK Josip	CRO
5.	MILJIC Sinisa	SRB
5.	AGHAKISHIYEV Mahammad	AZE
7.	DISTEL Roman	GER
7.	KRIVOLAPOV Egor	KGZ



# Teplice Millennium Team Cadet European Cup 2025

Czechia, Teplice, 5-6 Apr 2025

## -73 kg

Cadets (80)

POOL C

	RICHNER Suleyman	SUI	33	RICHNER S. (SUI)
	SOLAN Maksymilian	POL	34	SOLAN M. (POL)
	RAJCIC Marko	CRO	35	HAJIYEV A. (SWE)
	HAJIYEV Ali	SWE	35	000 s1/ 100 s1 [02:56]
	SUMALO Mykhailo	UKR	36	SUMALO M. (UKR)
	BEVERLO Justin	NED	37	GOMBKOTO M. (HUN)
	GOMBKOTO Misa	HUN	37	000 s1/ 003 s0 [04:00]
	KODRIC Luka	SLO	38	KODRIC L. (SLO)
	PONOMARENKO Ivan	GER	39	PONOMARENKO I. (GER)
	KATRANIDIS Ioannis	GRE	40	KATRANIDIS I. (GRE)
	KRIVOLAPOV Egor	KGZ	41	KRIVOLAPOV E. (KGZ)
	WILKOSZ Szymon	POL	42	WILKOSZ S. (POL)
	VORON Kyrlo	UKR	43	VORON K. (UKR)
	SCHNEIDER Darwin	GER	43	100 s1/ 000 s3 [07:49]
	LAFAZANIS Artem	AUT	44	LAFAZANIS A. (AUT)
	GRIGORJEV Emilis	LTU	45	GRIGORJEV E. (LTU)
	GERAULT Pierick	FRA	46	GERAULT P. (FRA)
	YELKENCI Emin Levent	TUR	47	YELKENCI E. (TUR)
	MINICH Michail	GER	47	001 s1/ 000 s1 [04:00]
	JICINSKY Radim	CZE	48	JICINSKY R. (CZE)

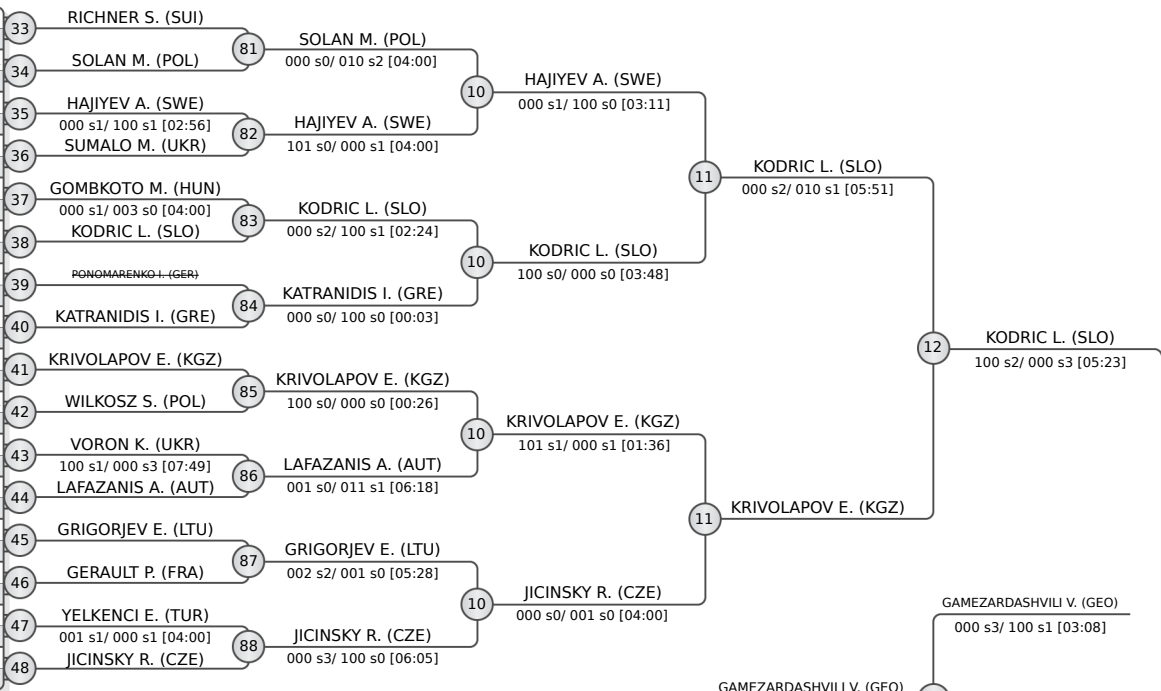

POOL D

	HAVRANEK Josip	CRO	49	HAVRANEK J. (CRO)
	BRUECKNER Hannes	GER	50	BORZECKI J. (POL)
	BORZECKI Jakub	POL	50	000 s0/ 100 s1 [03:32]
	IKEME MASCARO Sergi	ESP	51	IKEME MASCARO S. (ESP)
	CHARENKA Kajus	LTU	52	CHARENKA K. (LTU)
	KROTKO Til	SLO	53	CHEREMKHOV H. (UKR)
	CHEREMKHOV Hryhorii	UKR	53	000 s2/ 001 s1 [05:09]
	JAMAK Ahmed	BIH	54	JAMAK A. (BIH)
	MISHANOV Maksym	GER	55	MISHANOV M. (GER)
	FEKECS Gyula	HUN	56	FEKECS G. (HUN)
	HASANLI Aykhan	AZE	57	HASANLI A. (AZE)
	JALIC Uros	SRB	58	JALIC U. (SRB)
	SHADI Mohamed	AUT	58	011 s1/ 000 s1 [04:00]
	FONTANA Emanuele	ITA	59	FONTANA E. (ITA)
	FUNKE Thies	GER	60	FUNKE T. (GER)
	TELES Manuel	POR	61	TELES M. (POR)
	PIVNIUK Artem	UKR	62	PIVNIUK A. (UKR)
	SAAR Ken Marten	EST	63	WOZNIAK M. (POL)
	WOZNIAK Marcel	POL	63	000 s0/ 020 s1 [01:38]
	KLIMSA Jan	CZE	64	KLIMSA J. (CZE)

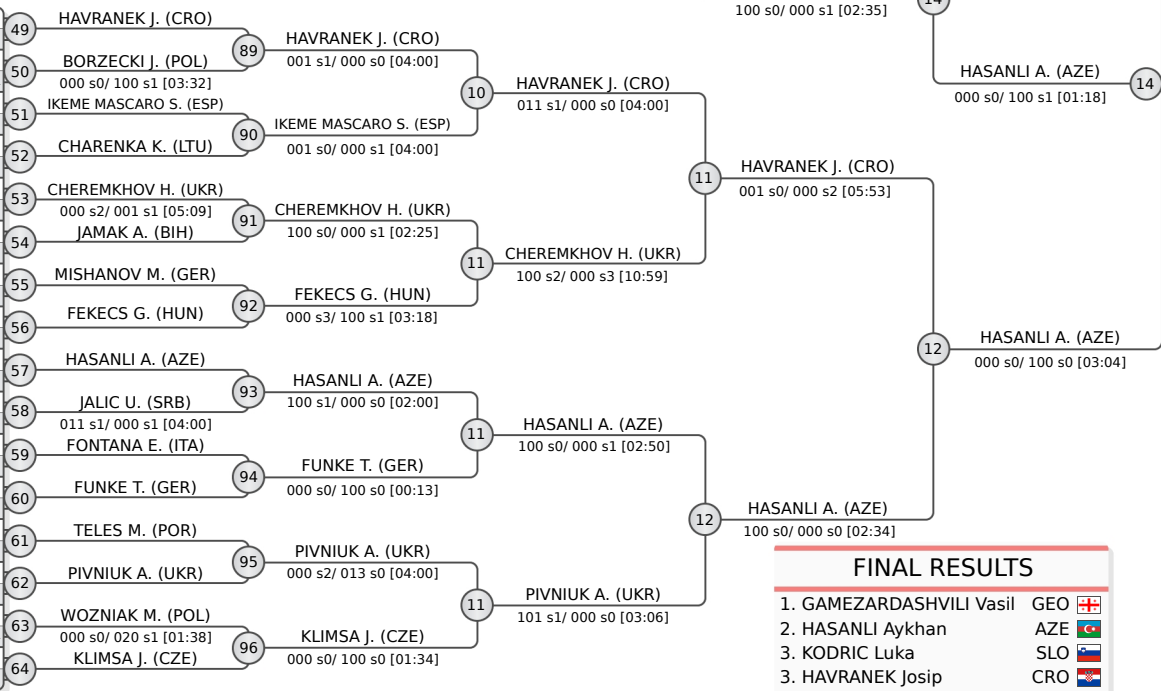

FINAL RESULTS	
1.	GAMEZARDASHVILI Vasil GEO
2.	HASANLI Aykhan AZE
3.	KODRIC Luka SLO
4.	HAVRANEK Josip CRO
5.	MILJIC Sinisa SRB
7.	AGHAKISHIYEV Mahammad AZE
7.	DISTEL Roman GER
7.	KRIVOLAPOV Egor KGZ

REPECHAGE

PIKTEL M. (POL)	12	PIKTEL M. (POL)
ZAK A. (CZE)	12	ZAK A. (CZE)
GOMBKOTO M. (HUN)	12	GOMBKOTO M. (HUN)
JALIC U. (SRB)	12	JALIC U. (SRB)

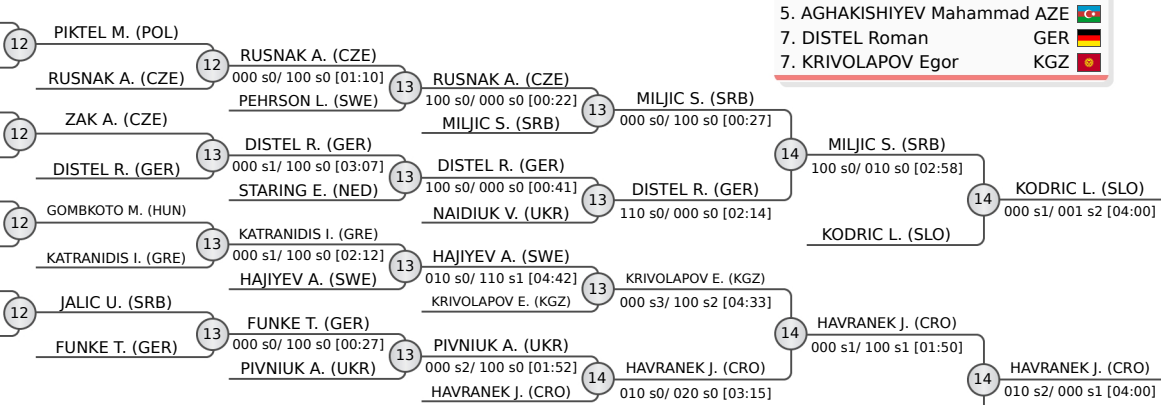





# Teplice Millennium Team Cadet European Cup 2025

Czechia, Teplice, 5-6 Apr 2025

## -81 kg

Cadets (59)

### POOL A

1	SOLIANYK Mykhailo (UKR)	1	SOLIANYK M. (UKR)
2	VLACH Marek (CZE)	2	VLACH M. (CZE)
3	TCHENDJE KENMEUE Arthur (FRA)	3	FREIRE GONZALEZ N. (ESP)
4	FREIRE GONZALEZ Nicolas (ESP)	4	MAN D. (ROU)
5	ARBULLA Alessandro (ITA)	5	MAN D. (ROU)
6	ADOLPH Jayden (GER)	6	SARBOCH A. (CZE)
7	MAN Darius (ROU)	7	VORONIN M. (POR)
8	SARBOCH Adam (CZE)	8	WOERMANSEDER K. (AUT)
9	SINCHUK Vladyslav (UKR)	9	GRAJFONER N. (SLO)
10	ERLICH Roland (GER)	10	WOERMANSEDER K. (AUT)
11	VORONIN Maksym (POR)	11	GRAJFONER N. (SLO)
12	WOERMANSEDER Klaus (AUT)	12	GRAJFONER N. (SLO)
13	CIBUR Michal (SVK)	13	GRAJFONER N. (SLO)
14	ABAKUNOV Petro (POL)	14	GRAJFONER N. (SLO)
15	GRAJFONER Niko (SLO)	15	GRAJFONER N. (SLO)

### POOL B

9	MUMLADZE Giorgi (GEO)	9	MUMLADZE G. (GEO)
10	BOROJEVIC Veljko (SRB)	10	BOROJEVIC V. (SRB)
11	CHARALAMPOUS Miltiadis (CYP)	11	SEMANJAKU E. (ITA)
12	SEMANJAKU Erik (ITA)	12	ROTAR M. (UKR)
13	AYDIN Arda (TUR)	13	ROTAR M. (UKR)
14	ROTDAR Maksym (UKR)	14	MEHDIYEV A. (AZE)
15	BERGLEZ KOS Val (SLO)	15	MEHDIYEV A. (AZE)
16	MEHDIYEV Amin (AZE)	16	VALA L. (CZE)
17	SVALINA Nikola (CRO)	17	VALA L. (CZE)
18	PERECZ Mark (HUN)	18	VALA L. (CZE)
19	FENSKI Ole (GER)	19	VALA L. (CZE)
20	MARGREITER Simon (AUT)	20	VALA L. (CZE)
21	VALA Lukas (CZE)	21	VALA L. (CZE)
22	SUPAKHUNOV David (LTU)	22	VALA L. (CZE)

### POOL C

17	BABAICENKO Tajus (LTU)	17	BABAICENKO T. (LTU)
18	VAN DEN HIL Mathijs (NED)	18	VAN DEN HIL M. (NED)
19	GROSS Tillmann (GER)	19	FICTUM M. (CZE)
20	FILIP Andrei (FRA)	20	FICTUM M. (CZE)
21	FICTUM Martin (CZE)	21	AMARO P. (POR)
22	CUCEREANU Liviu (AUT)	22	BETKOWSKI J. (POL)
23	AMARO Pedro (POR)	23	BETKOWSKI J. (POL)
24	BETKOWSKI Jeremiasz (POL)	24	KOTER T. (SLO)
25	LOEWEN Musa (GER)	25	ZADNIPRIANETS I. (UKR)
26	MIKLOSVOLGYI Mate (HUN)	26	ZADNIPRIANETS I. (UKR)
27	KERANEN Elmo (FIN)	27	ZADNIPRIANETS I. (UKR)
28	KERANEN Elmo (FIN)	28	ZADNIPRIANETS I. (UKR)
29	IANCU Robert (ROU)	29	ZADNIPRIANETS I. (UKR)
30	KOTER Tjan (SLO)	30	ZADNIPRIANETS I. (UKR)
31	ZUCCHERI Leonardo (ITA)	31	ZADNIPRIANETS I. (UKR)
32	ZADNIPRIANETS Ivan (UKR)	32	ZADNIPRIANETS I. (UKR)

### POOL D

25	KULLO Tits (LAT)	25	KULLO T. (LAT)
26	IAKOVOU Michalis (CYP)	26	IAKOVOU M. (CYP)
27	MARACHEV Pylip (UKR)	27	SCHEIBER F. (AUT)
28	SCHEIBER Felix (AUT)	28	SCHEIBER F. (AUT)
29	MATTSSON Wilmer (SWE)	29	SCHEIBER F. (AUT)
30	LECHOWICZ Marek (POL)	30	RAHMATOV A. (AZE)
31	BLASE Theodor (GER)	31	KLIMES V. (CZE)
32	RAHMATOV Abdullah (AZE)	32	RAHMATOV A. (AZE)
33	KOVSE Marko (SLO)	33	KLIMES V. (CZE)
34	ANESASVILI Varnito (GER)	34	KLIMES V. (CZE)
35	KLIMES Vojtech (CZE)	35	KLIMES V. (CZE)
36	MANDIC Veljko (SRB)	36	KLIMES V. (CZE)
37	SIGNORINI Nicolo (ITA)	37	KLIMES V. (CZE)
38	KARAKLIDIS Gkiorgki (GRE)	38	KLIMES V. (CZE)
39	SAKHAROV Nikita (UKR)	39	KLIMES V. (CZE)

### REPECHAGE

61	VLACH M. (CZE)	61	VLACH M. (CZE)
62	BOROJEVIC V. (SRB)	62	BOROJEVIC V. (SRB)
63	VAN DEN HIL M. (NED)	63	VAN DEN HIL M. (NED)
64	SIGNORINI N. (ITA)	64	SIGNORINI N. (ITA)
65	MAN D. (ROU)	65	MAN D. (ROU)
66	ROTAR M. (UKR)	66	ROTAR M. (UKR)
67	FICTUM M. (CZE)	67	FICTUM M. (CZE)
68	RAHMATOV A. (AZE)	68	RAHMATOV A. (AZE)
69	SARBOCH A. (CZE)	69	SARBOCH A. (CZE)
70	MEHDIYEV A. (AZE)	70	MEHDIYEV A. (AZE)
71	ZADNIPRIANETS I. (UKR)	71	ZADNIPRIANETS I. (UKR)
72	RAHMATOV A. (AZE)	72	RAHMATOV A. (AZE)
73	MUMLADZE G. (GEO)	73	MUMLADZE G. (GEO)
74	BABAICENKO T. (LTU)	74	BABAICENKO T. (LTU)
75	SARBOCH A. (CZE)	75	SARBOCH A. (CZE)
76	RAHMATOV A. (AZE)	76	RAHMATOV A. (AZE)
77	SAKHAROV N. (UKR)	77	SAKHAROV N. (UKR)
78	SOLIANYK M. (UKR)	78	SOLIANYK M. (UKR)

FINAL RESULTS		
1.	MUMLADZE Giorgi	GEO
2.	BABAICENKO Tajus	LTU
3.	SAKHAROV Nikita	UKR
5.	SOLIANYK Mykhailo	UKR
5.	SARBOCH Adam	CZE
7.	RAHMATOV Abdullah	AZE
7.	MEHDIYEV Amin	AZE
7.	ZADNIPRIANETS Ivan	UKR



# Teplice Millennium Team Cadet European Cup 2025

Czechia, Teplice, 5-6 Apr 2025

## -90 kg

Cadets (42)

POOL A

GENYS Majus	LTU
DZIAVORUK Ivan	UKR
NEACSU Rares	ROU
SAMUILAU Ivan	POL
MARX Gregor	AUT
HUSEYNOV Said	AZE
KORODI Zsombor	HUN
BELENDER Maxim	GER
NAUTA Jacob	NED
FERNANDES Diogo Salvador	POR
VUJICA Marko	CRO

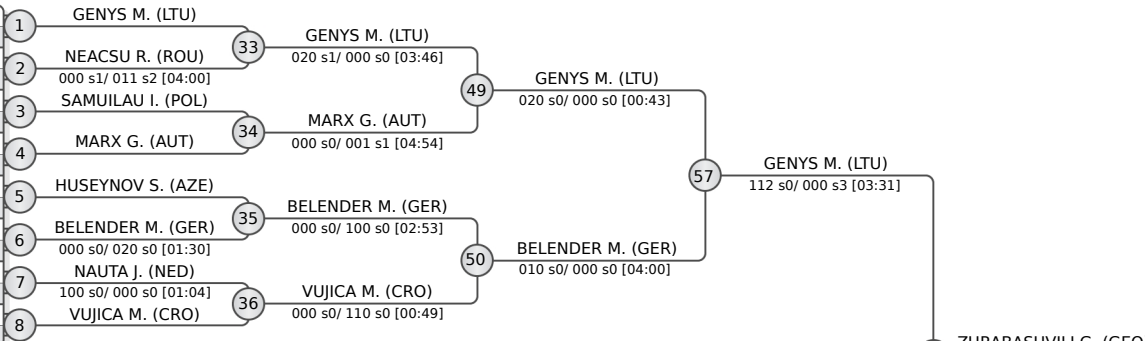

POOL B

ZURABASHVILI Giorgi	GEO
HECKO Daniel	SVK
CAPEZZUTO Antonio	ITA
JOVIC Dragan	SRB
BOYUNGA BOKULUTA Elie	FRA
ROMERO NAKHIL Carlos Karim	ESP
GOLTZ Jerome	GER
LAMBACKA Perttu	FIN
SZCZESNIAK Igor	POL
ROSENBERG Yoav	ISR

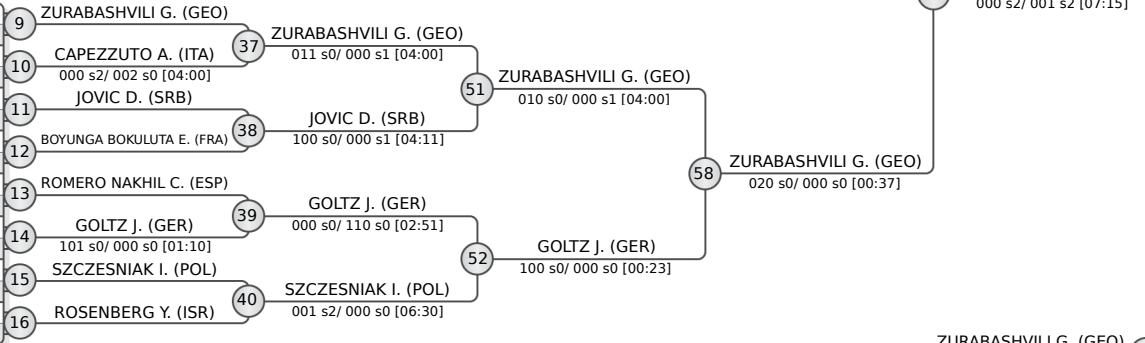

POOL C

MAKARENKO Artur	UKR
ROHDE Quint	NED
VOJINOVIC Lazar	BIH
PAWLAK Bartlomiej	POL
ZIZAK Nikola	CRO
PEREVERTAILO Kyrylo	UKR
VALENTIN Jeremy	LUX
SVATEK Jozef	SVK
D'HOOGHE Thor	SWE
ALIYEV Nuraddin	AZE
MORONI Leonardo	ITA

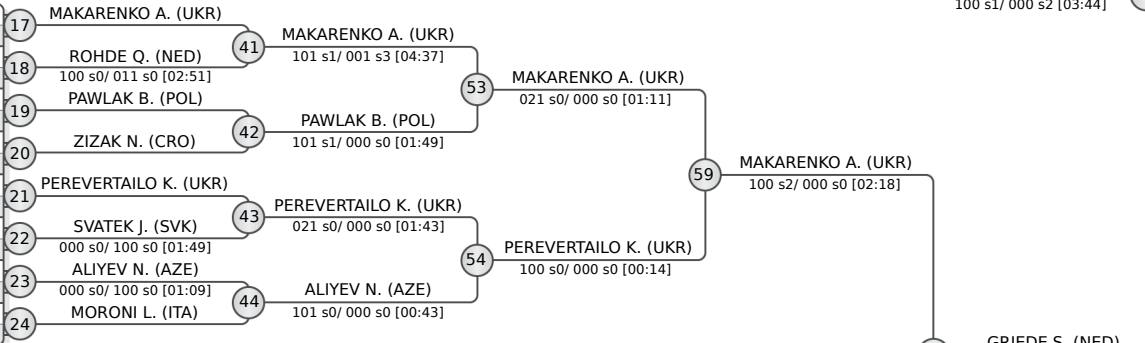

POOL D

GRIEDE Sieb	NED
MAREK Pawel	POL
SALAMON Barnabas	HUN
BARDIN Thibault	FRA
RICHTER Mikulas	CZE
PETRAUSKAS Majus	LTU
RUDI Eduard	GER
LOSANS Arnolds	LAT
CHLEBIK Samuel	SVK
OZEL Yusuf	TUR

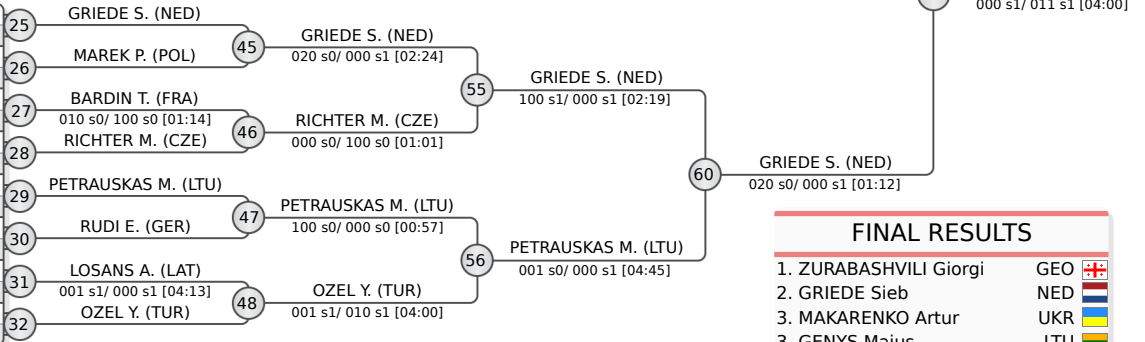

FINAL RESULTS	
1. ZURABASHVILI Giorgi	GEO
2. GRIEDE Sieb	NED
3. MAKARENKO Artur	UKR
3. GENYS Majus	LTU
5. NEACSU Rares	ROU
7. PEREVERTAILO Kyrylo	UKR
7. JOVIC Dragan	SRB
7. PETRAUSKAS Majus	LTU

REPECHAGE

NEACSU R. (ROU)	61	NEACSU R. (ROU)	65	NEACSU R. (ROU)	69
CAPEZZUTO A. (ITA)	62	MARX G. (AUT)	66	BELENDER M. (GER)	70
ROHDE Q. (NED)	63	JOVIC D. (SRB)	67	JOVIC D. (SRB)	71
MAREK P. (POL)	64	ROHDE Q. (NED)	68	PEREVERTAILO K. (UKR)	72

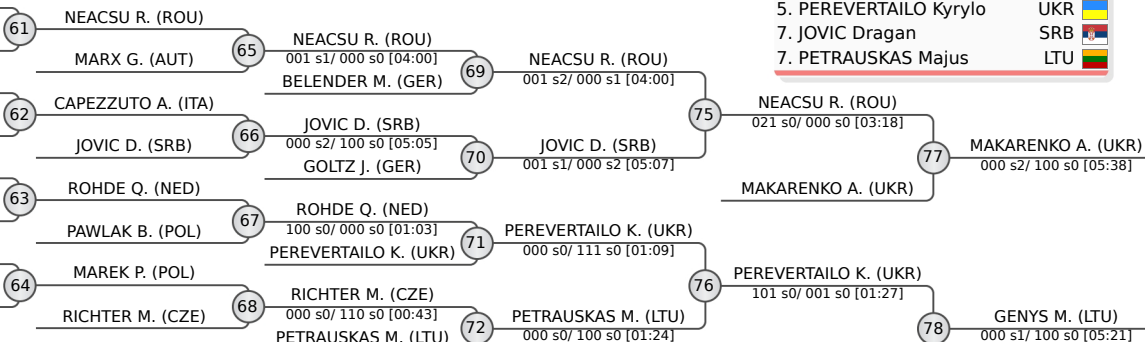



# Teplice Millennium Team Cadet European Cup 2025

Czechia, Teplice, 5-6 Apr 2025

## + 90 kg

Cadets (32)

POOL A

	AKHUNDOV Subhan	AZE
	LOFLING Pontus	SWE
	FRANGEZ Gal	SLO
	APSALONS Aleksandrs	LAT
	DEKENNE DIFFO Azriel	FRA
	NAZARCHUK Daniil	UKR
	BRUNNER Jan	CZE
	PALEICIKAS Nikolas	LTU

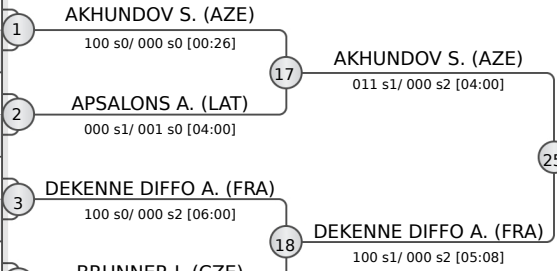

POOL B

	CSERMAK Daniel	HUN
	BISCHOFF Samuel	GER
	ZHADAN Serhii	UKR
	LABATE Federico	ITA
	ABALAKI Ioane	GEO
	NOVOTNY Jaroslav	CZE
	FLORENCIA Giovanni	NED
	TAURA Patrikas	LTU

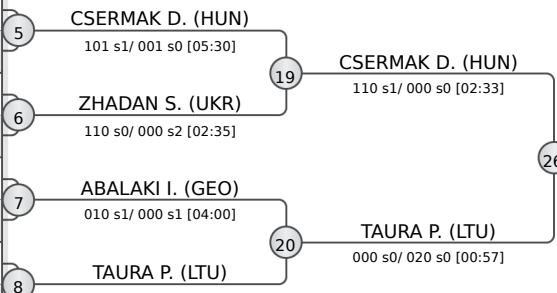

POOL C

	NOVAKOVIC Petar	SRB
	GURSKIJ Gabriel	LTU
	TEGELAAR Jack	SWE
	ANGERER Lukas	AUT
	SKODA Melichar	CZE
	HUBKO Yehor	UKR
	CUIBUS Raul	ROU
	FARZALIYEV Tunar	AZE

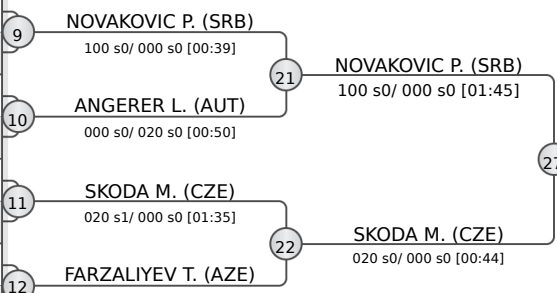

POOL D

	KARCHAIDZE Giorgi	GEO
	BEGIC Ivan	GER
	ELUARD Aaron	FRA
	TRUHLAR Martin	CZE
	SZEKERES Abel	HUN
	JESUS Miguel	POR
	KAMINSKI Dawid	POL
	TIUKH Yurii	UKR

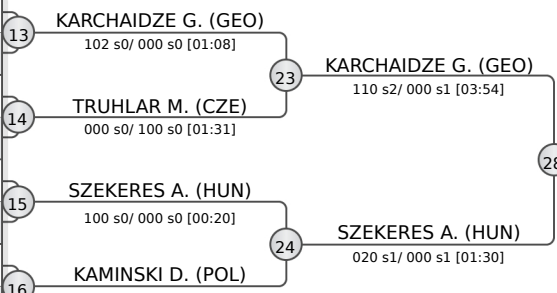

REPECHAGE

LOFLING P. (SWE)	29	APSALONS A. (LAT)	33
APSALONS A. (LAT)		DEKENNE DIFFO A. (FRA)	
BISCHOFF S. (GER)	30	ZHADAN S. (UKR)	34
ZHADAN S. (UKR)		TAURA P. (LTU)	
HUBKO Y. (UKR)	31	FARZALIYEV T. (AZE)	35
FARZALIYEV T. (AZE)		NOVAKOVIC P. (SRB)	
BEGIC I. (GER)	32	TRUHLAR M. (CZE)	36
TRUHLAR M. (CZE)		SZEKERES A. (HUN)	



FINAL RESULTS	
1. SKODA Melichar	CZE
2. AKHUNDOV Subhan	AZE
3. DEKENNE DIFFO Azriel	FRA
3. CSERMAK Daniel	HUN
5. KARCHAIDZE Giorgi	GEO
5. SZEKERES Abel	HUN
7. ZHADAN Serhii	UKR
7. FARZALIYEV Tunar	AZE



# Teplice Millennium Team Cadet European Cup 2025

Czechia, Teplice, 5-6 Apr 2025

## -40 kg

Cadets (12)

### POOL A

	COSKUN Busra Ceylin	TUR
	HRYHORENKO Anna	UKR
	MARIAN Daria	ROU

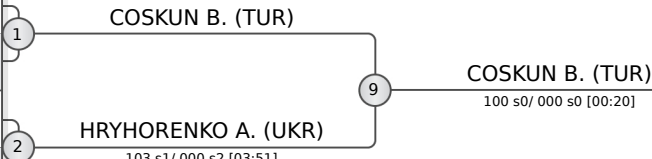

### POOL B

	PALAMARENKO Sofia	UKR
	HUSEYNOVA Madina	AZE
	GRACOVA Dominika	CZE

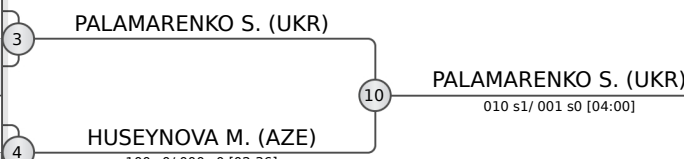

### POOL C

	DA COSTA Clelia	FRA
	LAVERGNE Joanne	FRA
	CIUMAS Bianca	ROU

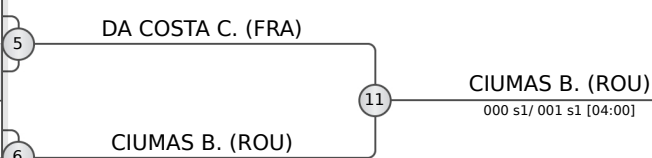

### POOL D

	YILMAZTURK Yagmur	TUR
	LIETI Alice	ITA
	TAKACS Nora	HUN

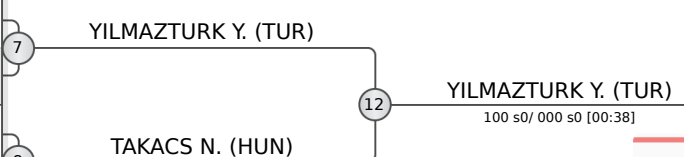

### REPECHAGE

HRYHORENKO A. (UKR)	13	HRYHORENKO A. (UKR)
HUSEYNOVA M. (AZE)	14	HUSEYNOVA M. (AZE)
LAVERGNE J. (FRA)	15	DA COSTA C. (FRA)
DA COSTA C. (FRA)	15	DA COSTA C. (FRA)
TAKACS N. (HUN)	16	TAKACS N. (HUN)

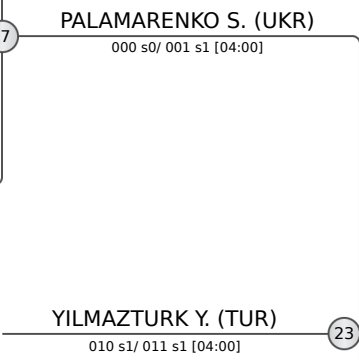
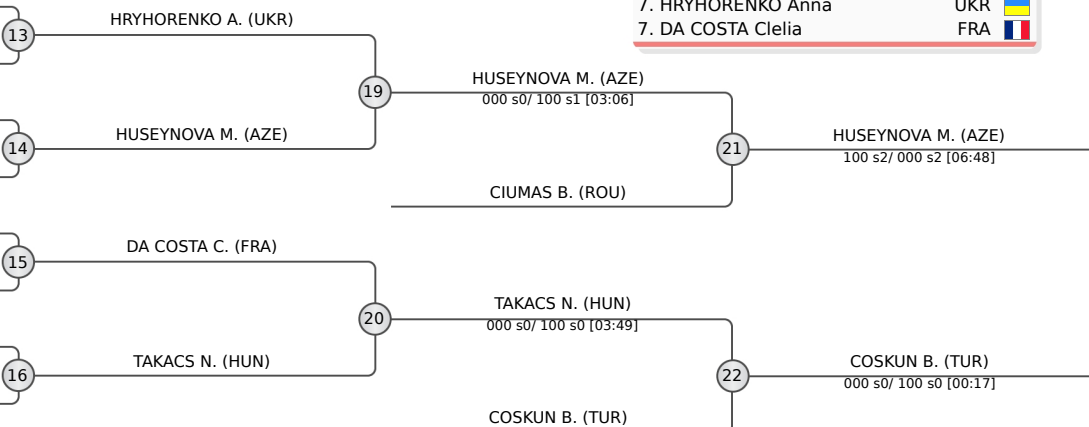

### FINAL RESULTS

1.	YILMAZTURK Yagmur	TUR	
2.	PALAMARENKO Sofia	UKR	
3.	HUSEYNOVA Madina	AZE	
3.	COSKUN Busra Ceylin	TUR	
5.	CIUMAS Bianca	ROU	
5.	TAKACS Nora	HUN	
7.	HRYHORENKO Anna	UKR	
7.	DA COSTA Clelia	FRA	



# Teplice Millennium Team Cadet European Cup 2025

Czechia, Teplice, 5-6 Apr 2025

## -44 kg

Cadets (26)

POOL A

	SERBAN Denisa	ROU
	DUDAS Regina	HUN
	MARTIN TORRES Jimena	ESP
	BLASZCZYK Julia	POL
	HUSEYNOVA Gulshan	AZE
	STORIONE Ludovica	ITA
	SEGURA Chloe	FRA

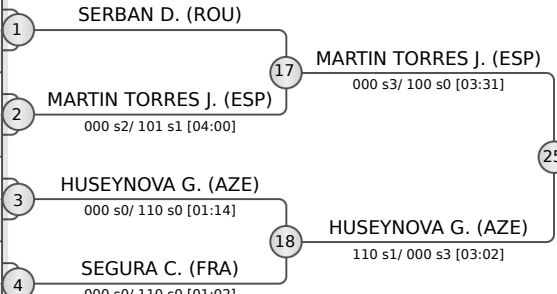

POOL B

	TIGANOV Cristina	ITA
	CUSA Carla	ROU
	GASPAR Matilde	POR
	GORANOVIC Katarina	SRB
	HLUSHCHENKO Tetiana	UKR
	ABDULLAYEVA Fatima	AZE

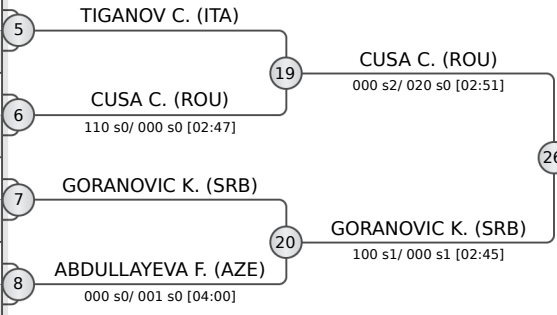

POOL C

	KAYIR Livanur	TUR
	SZCZEPANSKA Julia	POL
	ZVAJKER Sara	SLO
	SPONSELEE Mare	NED
	TANASE Abigail	ROU
	PECHORINA Yeva	UKR
	FERRO Aurora	ITA

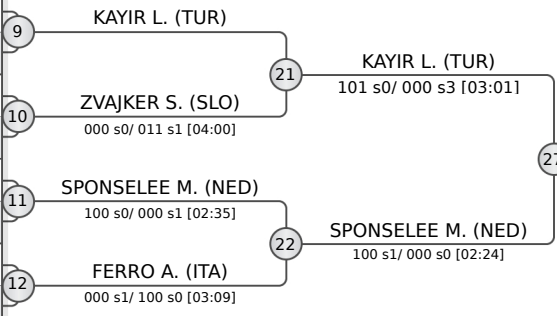

POOL D

	AUREL Mathilde	FRA
	LONGO Sofia	ITA
	BAHAMONDE GARCIA Elena	ESP
	ABDULLAYEVA Khadija	AZE
	SILVA Noa	POR
	RIEZNIK Vladyslava	UKR

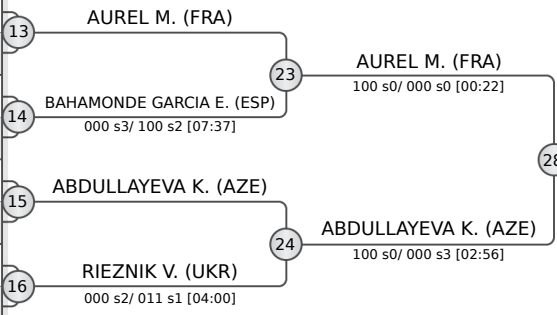

REPECHAGE

BLASZCZYK J. (POL)	BLASZCZYK J. (POL)	29
SEGURA C. (FRA)	MARTIN TORRES J. (ESP)	33
GASPAR M. (POR)	TIGANOV C. (ITA)	30
TIGANOV C. (ITA)	GORANOVIC K. (SRB)	34
TANASE A. (ROU)	FERRO A. (ITA)	31
FERRO A. (ITA)	KAYIR L. (TUR)	35
BAHAMONDE GARCIA E. (ESP)	ABDULLAYEVA K. (AZE)	36

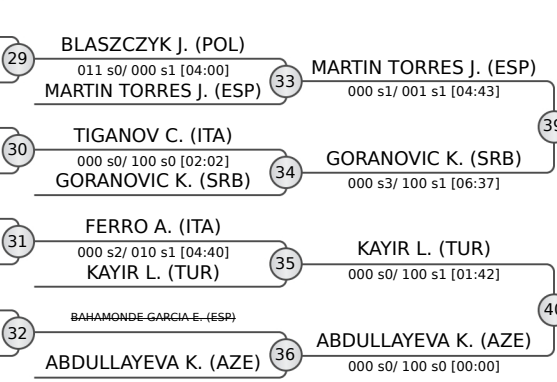

FINAL RESULTS	
1. AUREL Mathilde	FRA
2. HUSEYNOVA Gulshan	AZE
3. SPONSELEE Mare	NED
3. KAYIR Livanur	TUR
5. GORANOVIC Katarina	SRB
5. CUSA Carla	ROU
7. MARTIN TORRES Jimena	ESP
7. ABDULLAYEVA Khadija	AZE



# Teplice Millennium Team Cadet European Cup 2025

Czechia, Teplice, 5-6 Apr 2025

## -48 kg

Cadets (41)

POOL A

	KISS Viktoria	HUN	1
	TRAMPITSCH Maja	AUT	2
	MONTALBANO Aurora	ITA	3
	FALDT Lova	SWE	4
	ALAKBAROVA Leyla	AZE	4
	BRONZIN Alice	ITA	5
	FERTIG Maya	GER	6
	SIELSKA Zuzanna	POL	7
	BOSKUP Aysenur	TUR	7
	PRITULEAC Iana	MDA	8

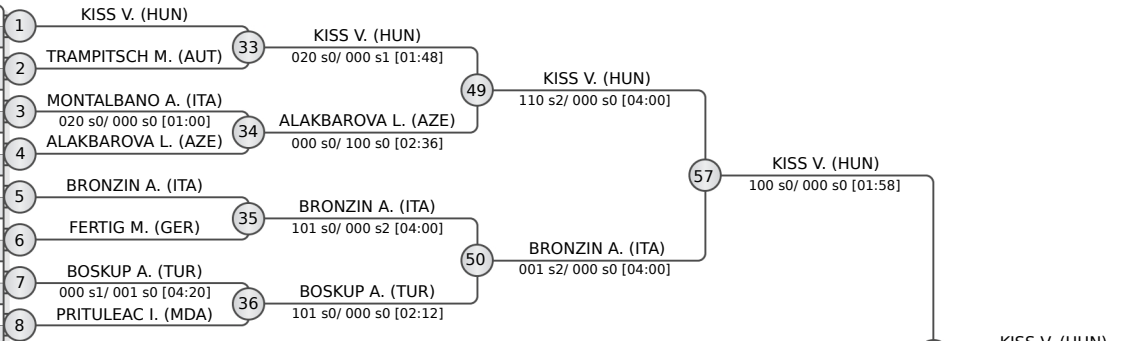

POOL B

	PODYMSKA Nina	POL	9
	MATEJKOVA Teresa	SVK	10
	IDDIR Celine	FRA	10
	MAYRHOFER Lena	AUT	11
	LIETI Sofia	ITA	12
	AHMADOVA Nargiz	AZE	12
	CHRISP Taylor	GBR	13
	HENDRIKS Tess	NED	14
	RASIC Mara	SRB	14
	MUNTEANU Ana Maria	ROU	15
	SOARES Maria	POR	16

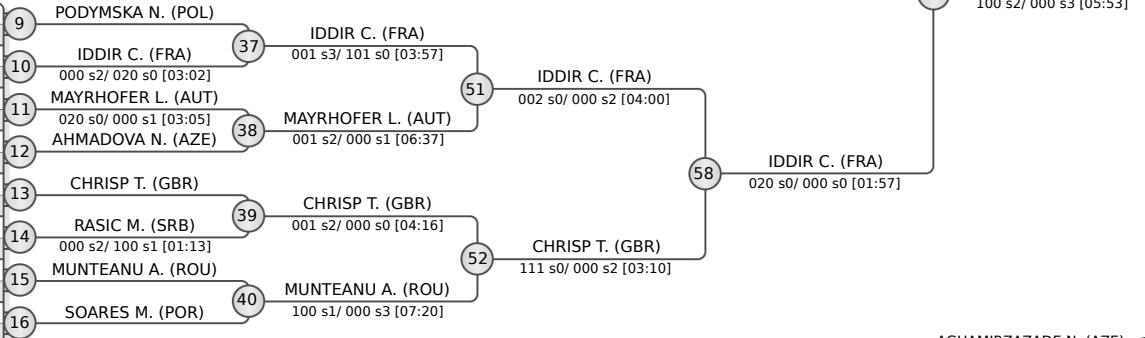

POOL C

	MOUSSATI Nourane	FRA	17
	PAPAI Stella	HUN	18
	PIELOCH Oliwia	POL	18
	ARTEAGA Evelin	SWE	19
	PULJIC Lucija	CRO	20
	EYVAZLI Konul	AZE	21
	NEDVYHA Yaroslava	UKR	22
	IVALDI Beatrice	ITA	23
	MERKVILADZE Salome	GEO	23
	GANGL Anna	AUT	24

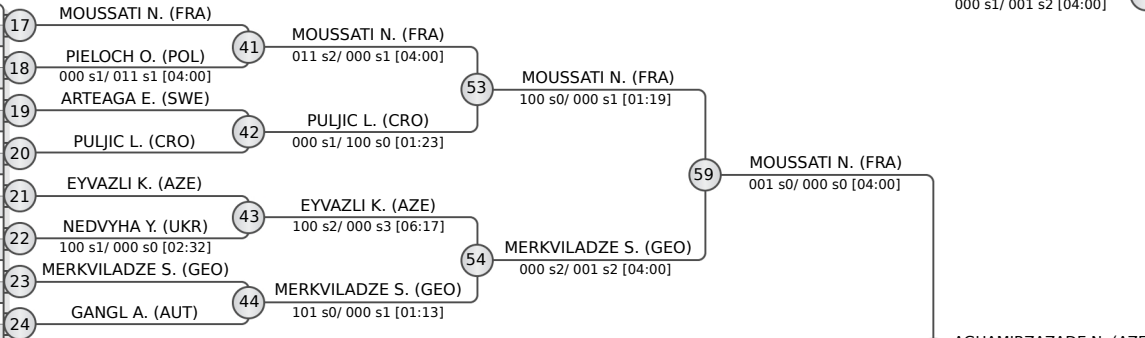

POOL D

	MANIBOG Malia	USA	25
	SOUSA LAVANDEIRA Zeltia	ESP	26
	AGHAMIRZAZADE Narmin	AZE	26
	ALOISE Ginevra	ITA	27
	PLICH Emily Chiara	GER	28
	PEREIRA Mariana	POR	29
	OANCEA Irina	ROU	30
	MANTYKENTTA Sara	FIN	30
	STOLLAROVA Sofia	SVK	31
	CZERWINSKA-KOWAR Karina	POL	32

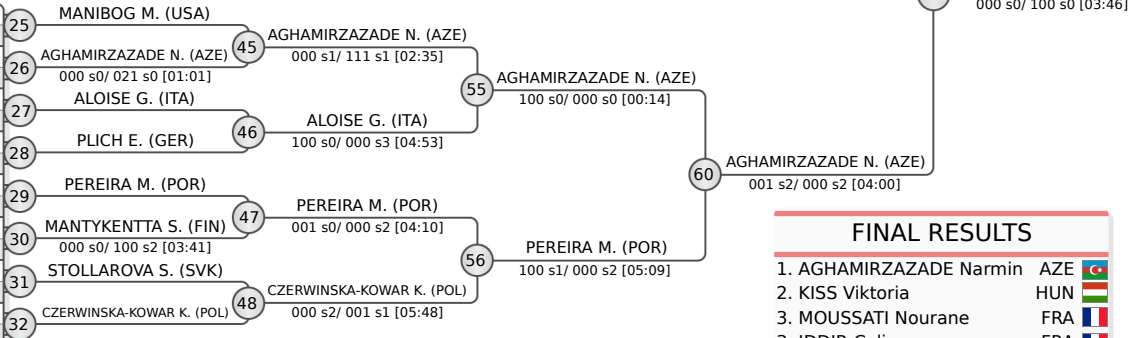

FINAL RESULTS		
1.	AGHAMIRZAZADE Narmin	AZE
2.	KISS Viktoria	HUN
3.	MOUSSATI Nourane	FRA
3.	IDDIR Celine	FRA
5.	MAYRHOFER Lena	AUT
5.	MERKVILADZE Salome	GEO
7.	BRONZIN Alice	ITA
7.	MANIBOG Malia	USA

REPECHAGE

	TRAMPITSCH M. (AUT)	61
	ALAKBAROVA L. (AZE)	65
	MATEJKOVA T. (SVK)	62
	PODYMSKA N. (POL)	62
	PIELOCH O. (POL)	63
	SOUSA LAVANDEIRA Z. (ESP)	64
	MANIBOG M. (USA)	64

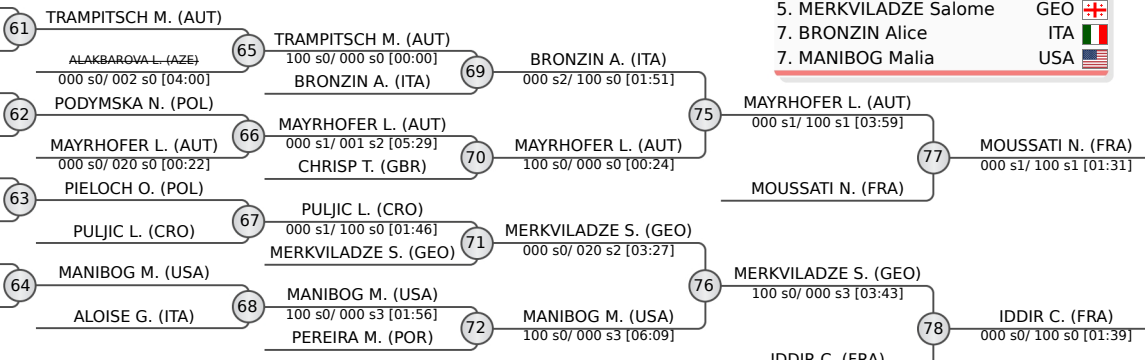



# Teplice Millennium Team Cadet European Cup 2025

Czechia, Teplice, 5-6 Apr 2025

## -52 kg

Cadets (44)

### POOL A

VAS Mira	HUN
HELCELETOVA Lilly Sofie	CZE
VADOVICOVA Vivien	SVK
GLAUNER Hannah	GER
GUION Sofia	ITA
STOJANOV Lenka	SRB
MONNEY Lya	SUI
LEMM Emilia	GER
LAHRIFI Lalla-Dounia	FRA
ZIVKOVIC Valentina	CRO
KYRYLCHUK Kseniia	UKR

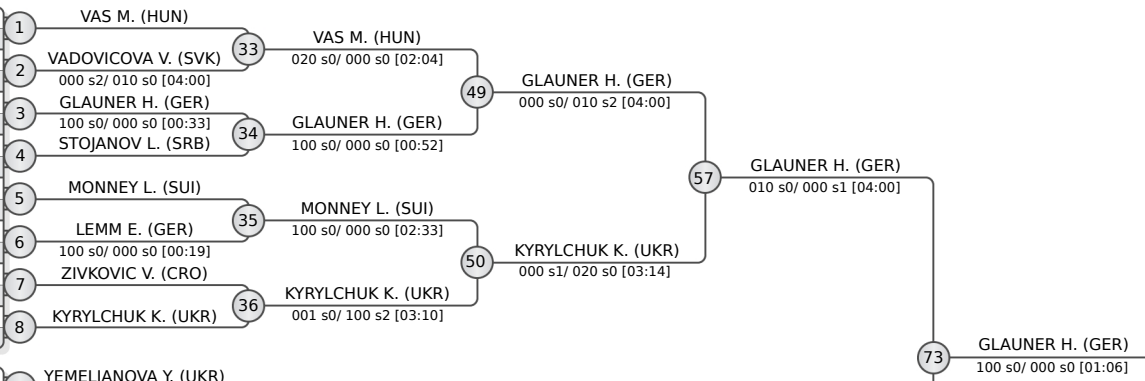

### POOL B

YEMELIANOVA Yelyzaveta	UKR
JIRASKOVA Darina	CZE
MAJEWSKA Julia	POL
TEISANU Teodora	ROU
SAS-ZALOZIECKI Valerie	AUT
GOTTFRIED Eleonora	GER
HAMDAOUI Dina-Syrine	FRA
XAVIER Maria	POR
ECKARDT Marissa	GER
SCHMITZ Lotus	NED
URBANOVA Natalie	CZE

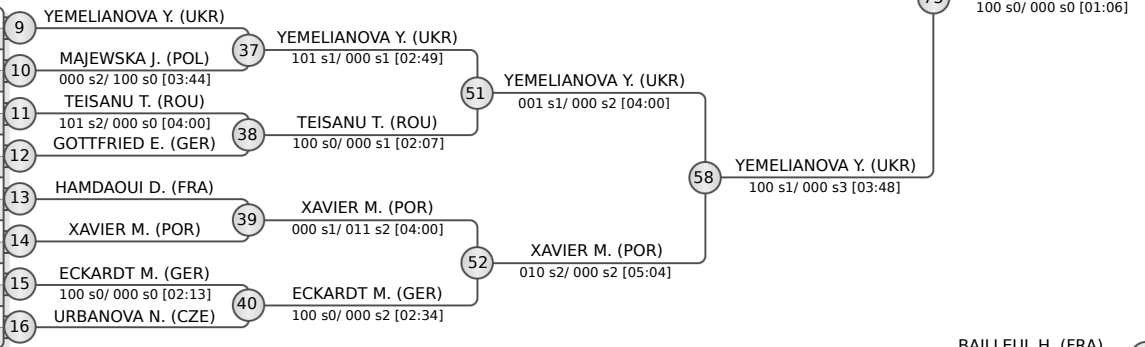

### POOL C

MOS Marika	POL
GREGOR Stefanie	GER
GALHARDAS Francisca	POR
PAJERICH Anna	HUN
TUCAJ Martina	CRO
KARNA Olivia	FIN
ZARUBA Viktorija	LTU
GUETH Sarah	GER
BABAYEVA Tovsiyya	AZE
POSPISILOVA Adela	CZE
NIUTTA Sofia	ITA

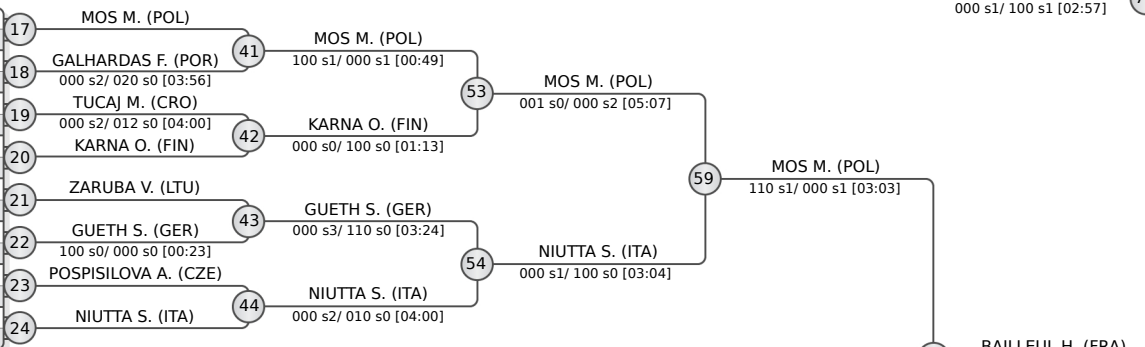

### POOL D

CORDOVA Sofia	SWE
TUMKO Polina	UKR
VAN DER KAMP Quinn	NED
WOERNER Daphne	GER
HAVLICKOVA Tereza	CZE
SLOTH HANSEN Alice	DEN
DI LEONARDO Noemi	ITA
WAMHOF Matilda	GER
OZDIL Aysenur	TUR
BAILLEUL Helea	FRA
GASPAR Sofia	POR

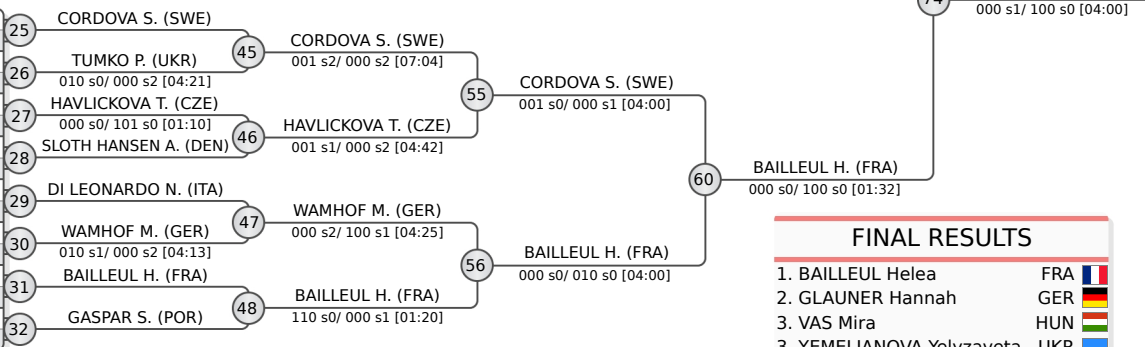

FINAL RESULTS		
1. BAILLEUL Helea	FRA	
2. GLAUNER Hannah	GER	
3. VAS Mira	HUN	
3. YEMELIANOVA Yelyzaveta	UKR	
5. MOS Marika	POL	
5. CORDOVA Sofia	SWE	
7. XAVIER Maria	POR	
7. NIUTTA Sofia	ITA	

### REPECHAGE

GUION S. (ITA)	61
STOJANOV L. (SRB)	62
MAJEWSKA J. (POL)	63
GALHARDAS F. (POR)	64
STOJANOV L. (SRB)	65
MAJEWSKA J. (POL)	66
GALHARDAS F. (POR)	67
GASPAR S. (POR)	68

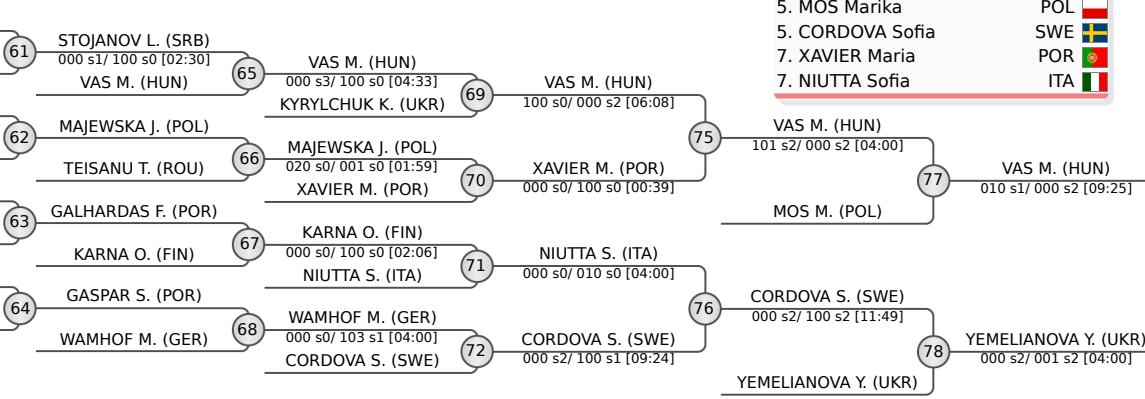



# Teplice Millennium Team Cadet European Cup 2025

Czechia, Teplice, 5-6 Apr 2025

## -57 kg

Cadets (81)

POOL A

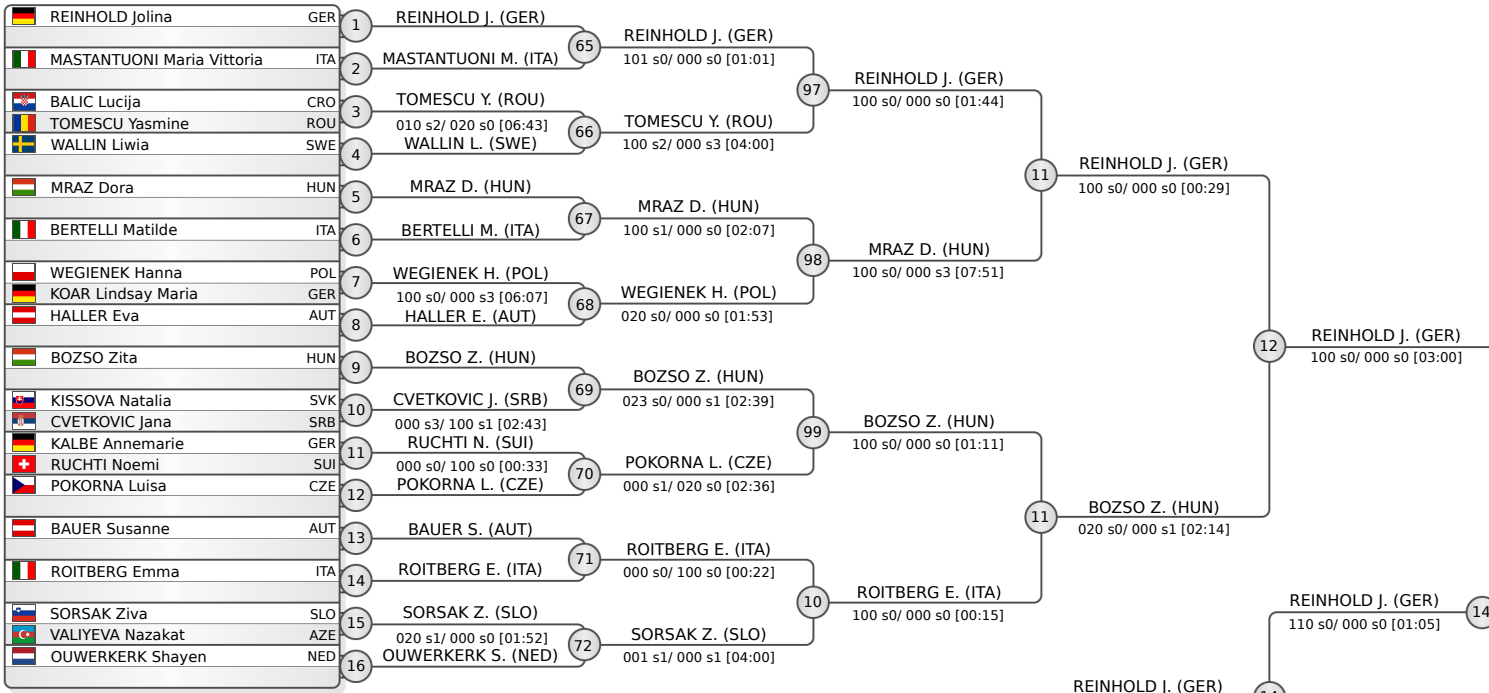

POOL B

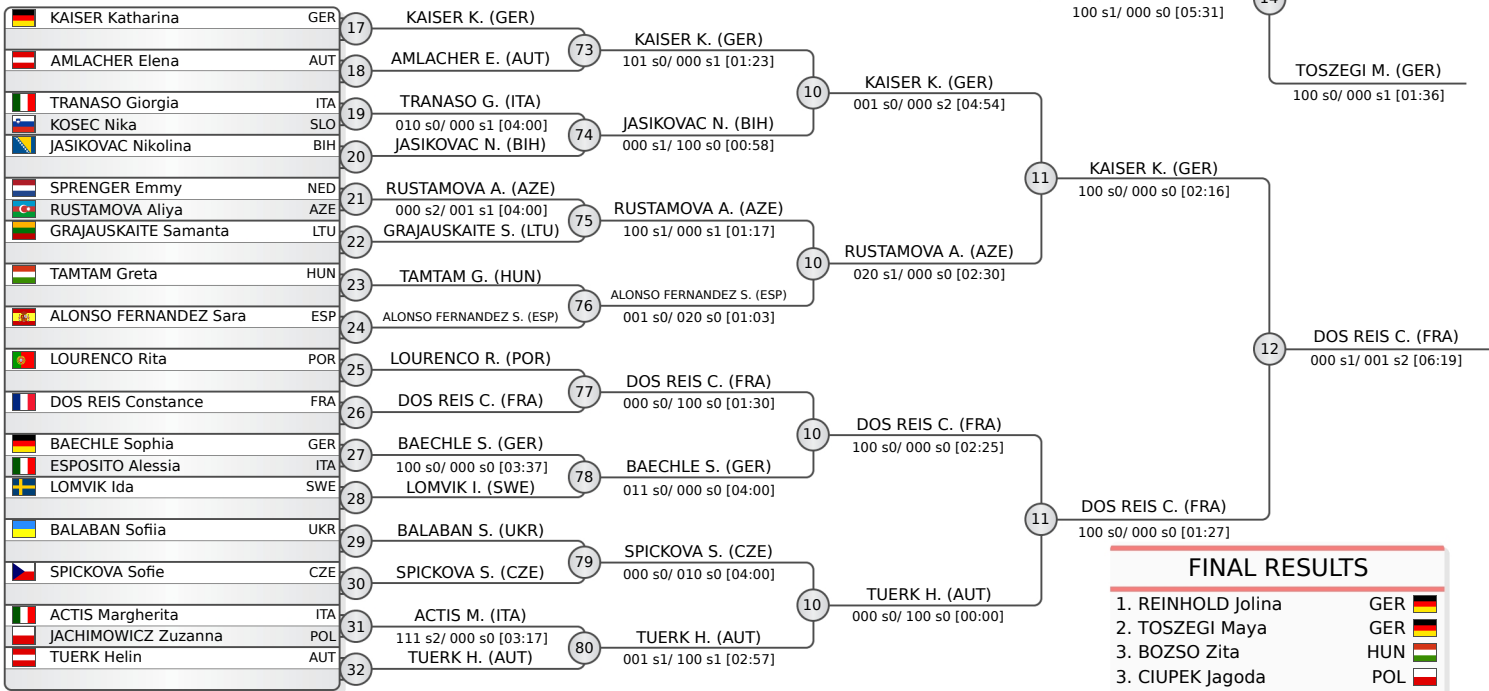

FINAL RESULTS	
1.	REINHOLD Jolina GER
2.	TOSZEGI Maya GER
3.	BOZSO Zita HUN
4.	CIUPEK Jagoda POL
5.	SIEMKO Julia POL
6.	DOS REIS Constance FRA
7.	KAISER Katharina GER
8.	VEINHANDBL OBAID Haya SLO

REPECHAGE

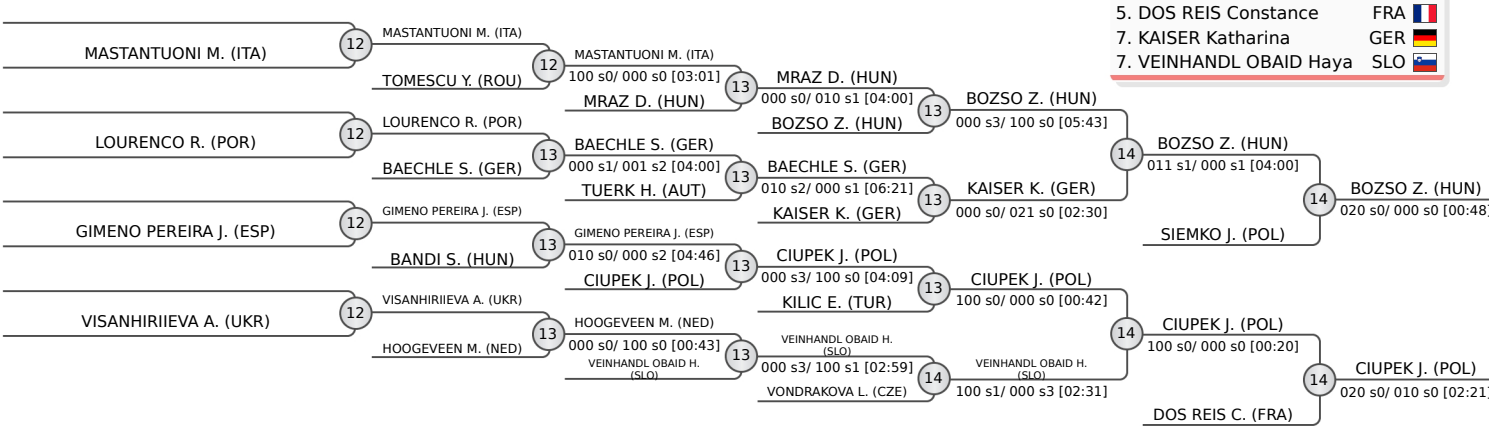





# Teplice Millennium Team Cadet European Cup 2025

Czechia, Teplice, 5-6 Apr 2025

## -57 kg

Cadets (81)

POOL C

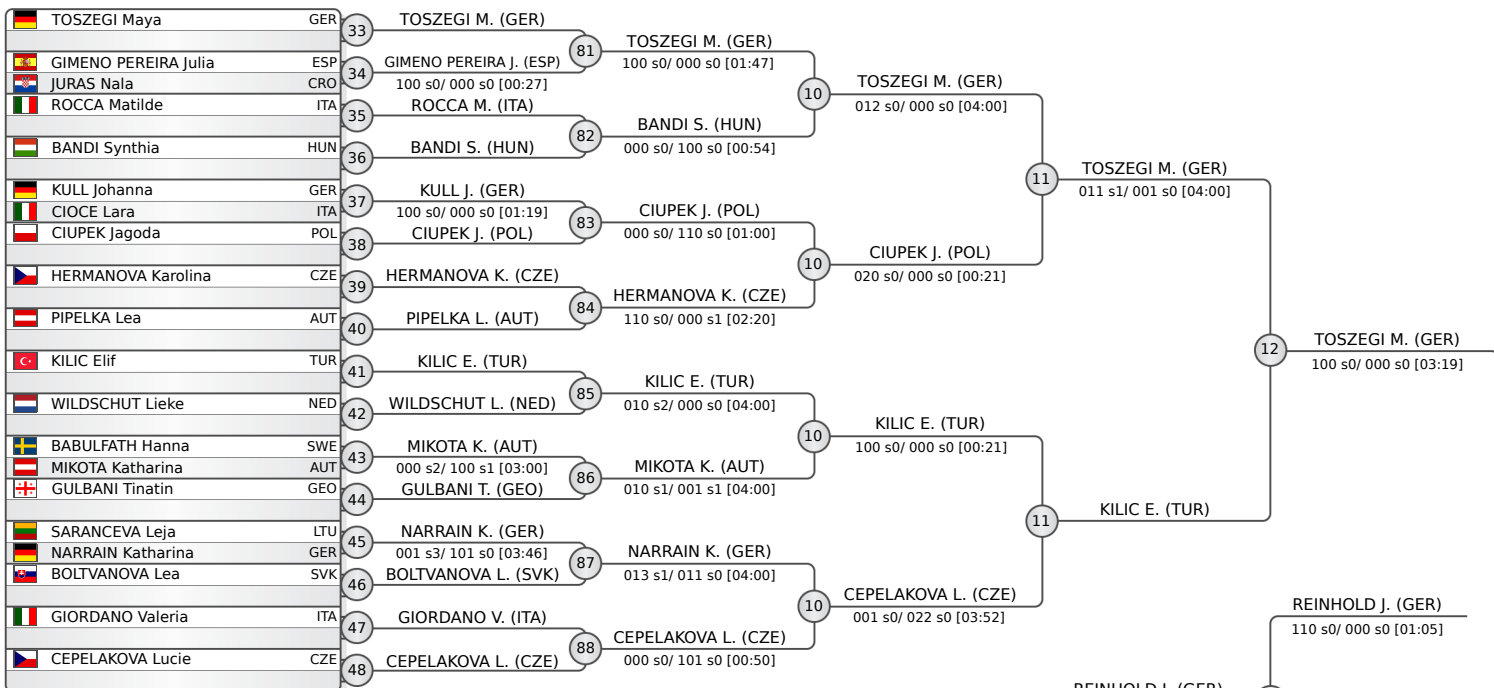

POOL D

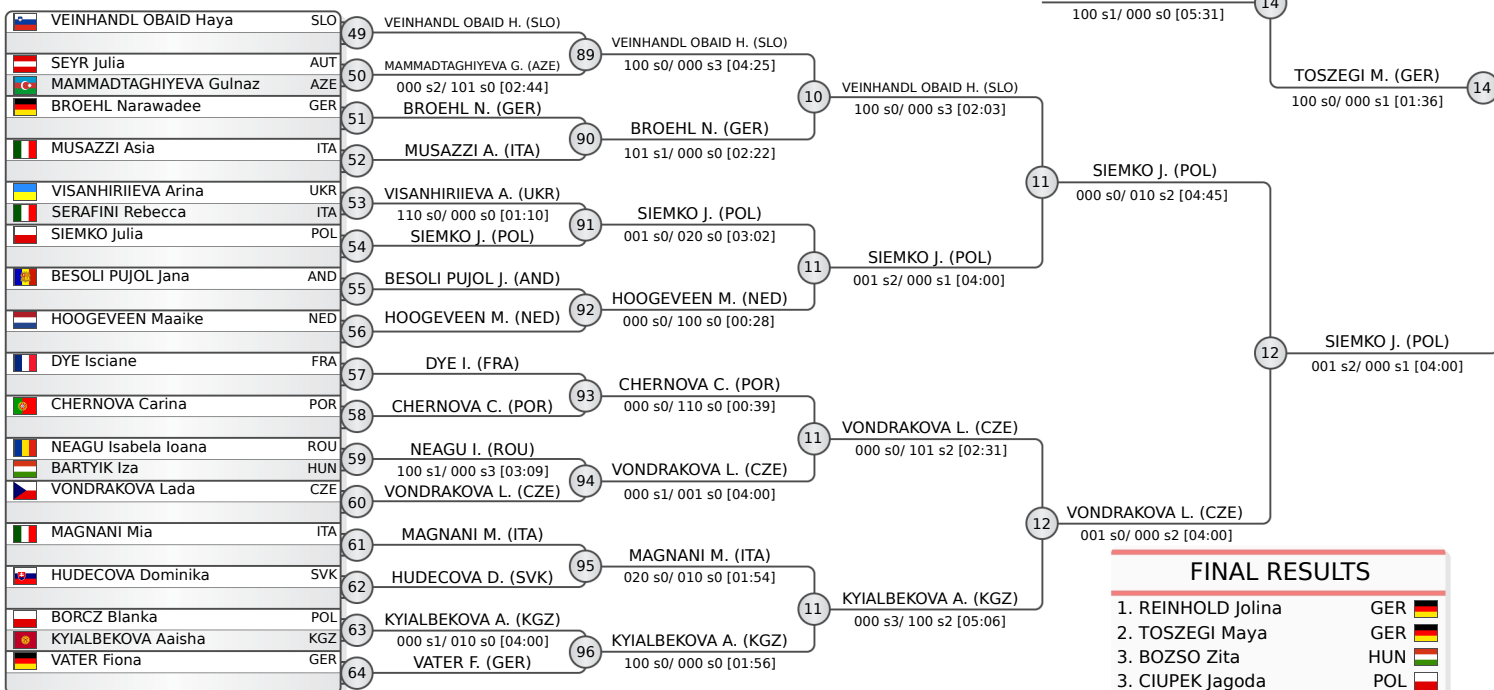

FINAL RESULTS		
1.	REINHOLD Jolina	GER
2.	TOSZEGI Maya	GER
3.	BOZSO Zita	HUN
3.	CIUPEK Jagoda	POL
5.	SIEMKO Julia	POL
5.	DOS REIS Constance	FRA
7.	KAISER Katharina	GER
7.	VEINHANDL OBAID Haya	SLO

REPECHAGE

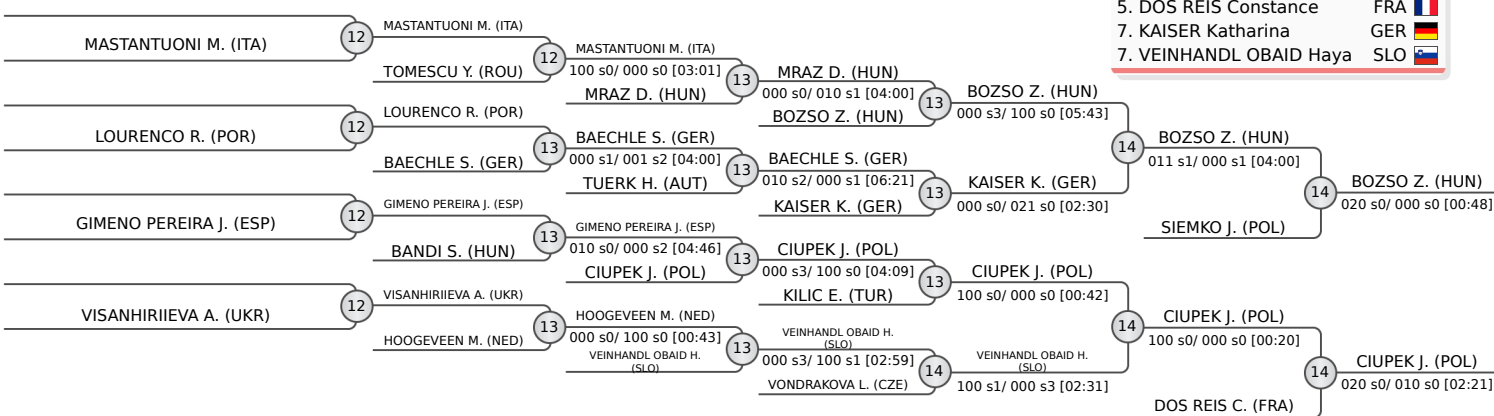



# Teplice Millennium Team Cadet European Cup 2025

Czechia, Teplice, 5-6 Apr 2025

# -63 kg

## Cadets (64)

### POOL A

1	TSURKAN Ilariia (UKR)	100 s0/ 000 s0 [00:34]	33	TSURKAN I. (UKR)	020 s0/ 000 s0 [00:29]
2	ADAMACHI Maya (ROU)	010 s0/ 000 s1 [04:00]			
3	WENDT Lena (GER)	020 s0/ 000 s0 [03:51]	34	WENDT L. (GER)	110 s0/ 000 s1 [01:54]
4	SISKOVA Stela (CZE)	000 s0/ 020 s0 [01:36]			
5	GUENNEUGUES Audren (FRA)	020 s0/ 000 s0 [00:59]	35	KOMODOWSKI I. (DEN)	000 s0/ 020 s0 [01:27]
6	KOMODOWSKI Ingrid (DEN)	000 s1/ 100 s0 [03:04]			
7	AKOPJAN Adele (GER)	000 s0/ 100 s0 [00:30]	36	JANCIKOVA M. (CZE)	000 s3/ 100 s1 [05:34]
8	JANCIKOVA Monika (CZE)	000 s0/ 020 s0 [01:18]			

### POOL B

9	SADILKOVA Zuzana (CZE)	110 s1/ 001 s0 [03:27]	37	CAVAGLIA M. (ITA)	000 s0/ 010 s0 [04:00]
10	CAVAGLIA Marika (ITA)	000 s3/ 100 s1 [04:38]			
11	RAMA B. (AUT)	000 s0/ 110 s1 [03:02]	38	SELAN P. (SLO)	000 s0/ 100 s0 [00:49]
12	AYDIN Isil Sinem (TUR)	101 s0/ 000 s0 [02:29]			
13	PAVLOVIC Nevena (SRB)	100 s0/ 000 s0 [01:19]	39	PAVLOVIC N. (SRB)	100 s0/ 000 s1 [00:40]
14	KOPACZ Sarolta (ROU)	000 s3/ 100 s0 [04:47]			
15	POKLOPOVA Lucie (CZE)	010 s2/ 000 s2 [05:24]	40	POKLOPOVA L. (CZE)	100 s2/ 000 s3 [08:27]
16	STOCK Luisa (GER)	100 s0/ 000 s0 [01:18]			

### POOL C

17	FROSONI Giorgia (ITA)	101 s0/ 000 s0 [00:56]	41	FROSONI G. (ITA)	110 s0/ 000 s3 [03:24]
18	GLIGA Ana (ROU)	000 s0/ 011 s0 [04:00]			
19	RYBICKA Agata (POL)	010 s1/ 100 s1 [01:37]	42	KLINKEBIEL J. (GER)	000 s0/ 102 s0 [02:37]
20	KLINKEBIEL Julia (GER)	100 s0/ 000 s1 [01:37]			
21	KILICKAYA Rumeysa Hatice (TUR)	020 s1/ 000 s0 [03:47]	43	STORM S. (GER)	000 s1/ 110 s1 [01:49]
22	STORM Sophia Grace (GER)	000 s0/ 020 s0 [02:44]			
23	ROEMMER Amelie (GER)	020 s0/ 000 s1 [04:00]	44	ROEMMER A. (GER)	101 s0/ 000 s0 [01:42]
24	GOMBA-LOUIS-JEAN Kaylia (FRA)	000 s0/ 101 s0 [04:00]			

### POOL D

25	BUETTNER Alesia (GER)	100 s0/ 000 s2 [02:40]	45	BUETTNER A. (GER)	020 s1/ 000 s0 [03:02]
26	BACHLER Anna (AUT)	102 s1/ 000 s2 [04:00]			
27	CIESZYNSKA Oliwia (POL)	100 s0/ 000 s0 [02:16]	46	POPOVIC K. (CRO)	000 s0/ 102 s0 [01:42]
28	POPOVIC Kaja (CRO)	000 s0/ 100 s0 [00:29]			
29	SAMOILIU D. (UKR)	020 s1/ 000 s0 [02:50]	47	SAMOILIU D. (UKR)	100 s0/ 000 s1 [02:31]
30	JEAN C. (FRA)	000 s0/ 110 s0 [00:18]			
31	SCERBOVA Amalie (CZE)	100 s0/ 010 s0 [01:42]	48	SCERBOVA A. (CZE)	110 s0/ 000 s0 [02:22]
32	KONNAPER E. (EST)	000 s0/ 100 s0 [02:16]			

### REPECHAGE

61	ADAMACHI M. (ROU)	000 s1/ 110 s0 [01:56]	65	WENDT L. (GER)	000 s0/ 110 s0 [03:44]
62	KULIKAUSKAITE M. (LTU)	101 s1/ 000 s0 [02:38]	66	POKLOPOVA L. (CZE)	000 s2/ 020 s0 [04:00]
63	KILICKAYA R. (TUR)	101 s0/ 000 s1 [01:34]	67	KILICKAYA R. (TUR)	101 s0/ 000 s1 [01:34]
64	JEAN C. (FRA)	001 s2/ 000 s2 [04:00]	68	SCERBOVA A. (CZE)	001 s2/ 000 s2 [04:00]
69	KOMODOWSKI I. (DEN)	000 s0/ 100 s1 [03:15]	70	CAVAGLIA M. (ITA)	000 s1/ 010 s0 [05:09]
71	KILICKAYA R. (TUR)	100 s2/ 000 s3 [04:17]	72	JEAN C. (FRA)	100 s0/ 000 s0 [01:11]

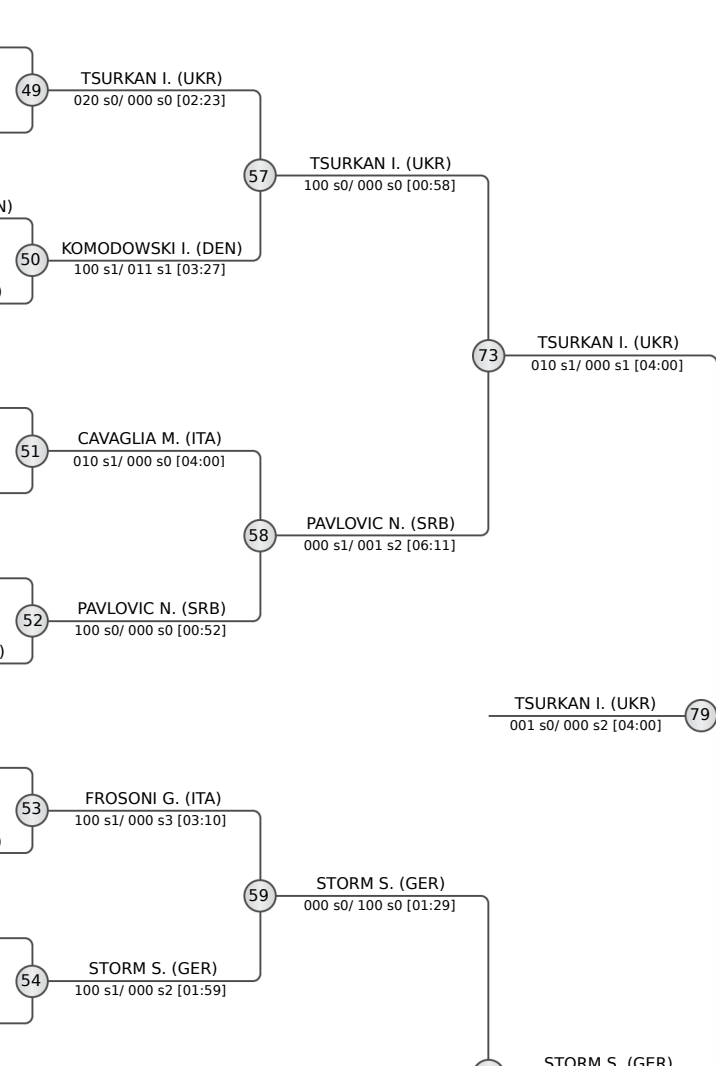

FINAL RESULTS		
1.	TSURKAN Ilariia	UKR
2.	STORM Sophia Grace	GER
3.	SAMOILIU Diana	UKR
3.	PAVLOVIC Nevena	SRB
5.	CAVAGLIA Marika	ITA
5.	JEAN Chloe	FRA
7.	KOMODOWSKI Ingrid	DEN
7.	KILICKAYA Rumeysa Hatice	TUR



# Teplice Millennium Team Cadet European Cup 2025

Czechia, Teplice, 5-6 Apr 2025

## -70 kg

Cadets (42)

POOL A

1	WELTER Leni (LUX)	2	WELTER L. (LUX)
2	RAGAUSKAITE Viktorija (LTU)	3	RAGAUSKAITE V. (LTU)
3	CAFARO Ginevra Margherita Pia (ITA)	4	CAFARO G. (ITA)
4	GOTTSCHALK Hedda (GER)	5	CAFARO G. (ITA)
5	SMUSZOVA Jirina (CZE)	6	SMUSZOVA J. (CZE)
6	BOB Isabel (ROU)	7	BOB I. (ROU)
7	KEDING Svenja (GER)	8	KEDING S. (GER)
8	BAUMANN Rosalie (AUT)	9	MAMMADLI M. (AZE)
9	MAMMADLI Masuma (AZE)	10	ZUIDWIJK N. (NED)
10	ZUIDWIJK Noel (NED)	11	ZUIDWIJK N. (NED)

POOL B

9	BOELCSKEI Hanna (GER)	10	BOELCSKEI H. (GER)
10	SHIVITZ Mia (ITA)	11	SHIVITZ M. (ITA)
11	OMACKOVA Amalie (CZE)	12	DZAGANIA N. (GEO)
12	DZAGANIA Nini (GEO)	13	DZAGANIA N. (GEO)
13	PANOVICS Hanga (HUN)	14	DOVHUN Y. (UKR)
14	DOVHUN Yana (UKR)	15	GRASSI G. (ITA)
15	GRASSI Giorgia (ITA)	16	GRASSI G. (ITA)
16	LATKOWSKI Antonia (GER)	17	LATKOWSKI A. (GER)
17	PAVIC Natasa (AUT)	18	DOGSA L. (SLO)
18	DOGSA Lara (SLO)	19	BOGDAN S. (ROU)
19	BOGDAN Smaranda (ROU)	20	BOGDAN S. (ROU)

POOL C

17	MENANTEAU Jeanne (FRA)	18	MENANTEAU J. (FRA)
18	KARAFFOVA Vanessa (CZE)	19	KARAFFOVA V. (CZE)
19	MICHAIL Maria (CYP)	20	WAGNER E. (GER)
20	DALL ASTA Margherita (ITA)	21	WAGNER E. (GER)
21	WAGNER Emelie (GER)	22	MRAVCAKOVA K. (SVK)
22	MRAVCAKOVA Karolina (SVK)	23	FEHER Z. (ROU)
23	FEHER Zara (ROU)	24	FEHER Z. (ROU)
24	ZOLEZZI Noemi (ITA)	25	JURCIKOVA V. (CZE)
25	JURCIKOVA Viktorie (CZE)	26	JURCIKOVA V. (CZE)
26	MALCZAK Lara Katharina (GER)	27	MALCZAK L. (GER)
27	RABL Mavie (AUT)	28	RABL M. (AUT)
28	RABL M. (AUT)	29	RABL M. (AUT)

POOL D

25	KURDGELIA Elene (GEO)	26	KURDGELIA E. (GEO)
26	JAMER Lara (SLO)	27	JAMER L. (SLO)
27	AHMADOVA Rena (AZE)	28	FARAUANU I. (ROU)
28	FARAUANU Iasmina (ROU)	29	FILZWIESER E. (AUT)
29	FILZWIESER Emma (AUT)	30	FILZWIESER E. (AUT)
30	WOEGERER Selina (AUT)	31	WOEGERER S. (AUT)
31	WOEGERER Selina (AUT)	32	ENS D. (GER)
32	ENS Daaje (GER)	33	ZENUNI Sara (ITA)
33	ZENUNI Sara (ITA)	34	KUCEROVA A. (CZE)
34	KUCEROVA Anna (CZE)	35	MOREIRA J. (POR)
35	MOREIRA Joana (POR)	36	MOREIRA J. (POR)

REPECHAGE

61	MAMMADLI M. (AZE)	62	MAMMADLI M. (AZE)
62	LATKOWSKI A. (GER)	63	LATKOWSKI A. (GER)
63	MICHAIL M. (CYP)	64	DOGSA L. (SLO)
64	MENANTEAU J. (FRA)	65	MENANTEAU J. (FRA)
65	MENANTEAU J. (FRA)	66	WAGNER E. (GER)
66	JAMER L. (SLO)	67	JAMER L. (SLO)
67	FILZWIESER E. (AUT)	68	FILZWIESER E. (AUT)
68	WOEGERER S. (AUT)	69	WOEGERER S. (AUT)
69	WOEGERER S. (AUT)	70	WOEGERER S. (AUT)
70	WOEGERER S. (AUT)	71	WOEGERER S. (AUT)
71	WOEGERER S. (AUT)	72	WOEGERER S. (AUT)
72	WOEGERER S. (AUT)	73	WOEGERER S. (AUT)
73	WOEGERER S. (AUT)	74	WOEGERER S. (AUT)
74	WOEGERER S. (AUT)	75	WOEGERER S. (AUT)
75	WOEGERER S. (AUT)	76	WOEGERER S. (AUT)
76	WOEGERER S. (AUT)	77	WOEGERER S. (AUT)
77	WOEGERER S. (AUT)	78	WOEGERER S. (AUT)
78	WOEGERER S. (AUT)	79	WOEGERER S. (AUT)

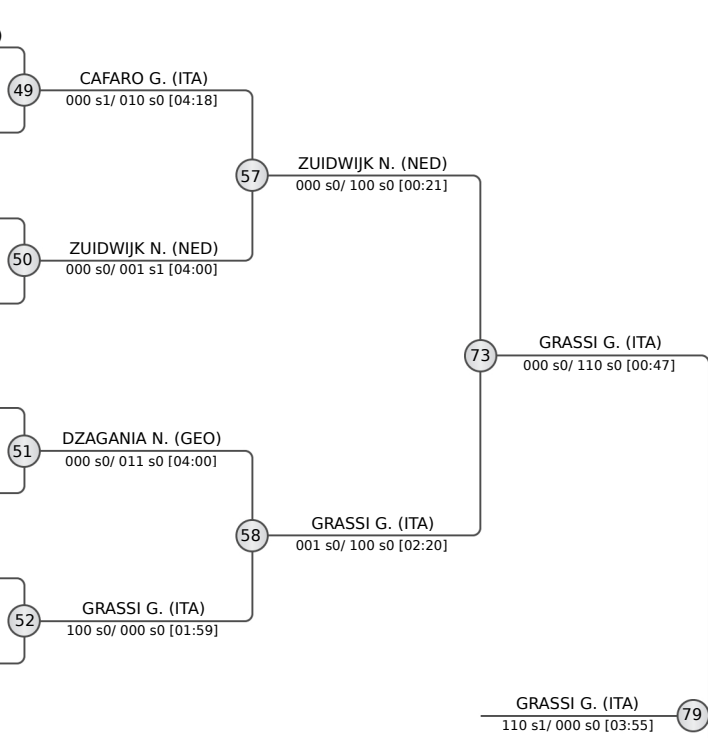

1.	GRASSI Giorgia	ITA	
2.	KURDGELIA Elene	GEO	
3.	DZAGANIA Nini	GEO	
3.	WOEGERER Selina	AUT	
5.	KARAFFOVA Vanessa	CZE	
5.	ZUIDWIJK Noel	NED	
7.	CAFARO Ginevra Margherita Pia	ITA	
7.	MENANTEAU Jeanne	FRA	



# Teplice Millennium Team Cadet European Cup 2025

Czechia, Teplice, 5-6 Apr 2025

## +70 kg

Cadets (26)

POOL A

ZAREBA Nikola	POL
ALIYEVA Zemfira	AZE
PALERMO Elisa	ITA
DILGER Elina	GER
HVALEC Klara	SLO
COULIBALY TOURE Ballalo	ESP
KHIMCHYK Myroslava	UKR

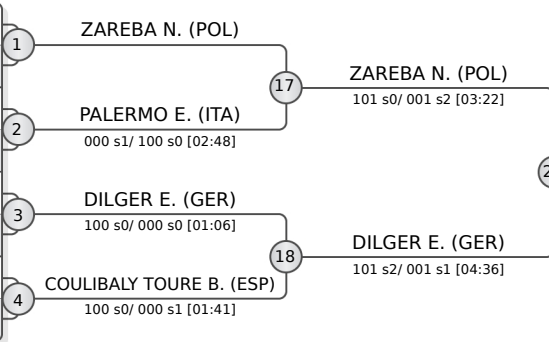

POOL B

HOELLWART Michaela	AUT
BAHMET Kira	UKR
FERREIRA Margarida	POR
SACKO Astan	FRA
VAN DRIEL Nova	NED
PFISTER Arlette	GER

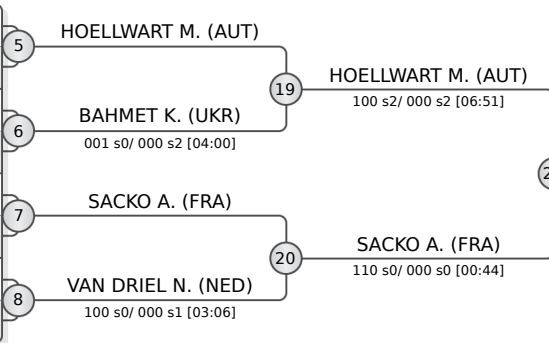

POOL C

SCHIAVON Carlotta	ITA
JURAK Jazmin	HUN
BARTHEL Tina	GER
SERIN Nisanur	TUR
SKRABAN Lana	SLO
SAMOLIUK Anna	UKR
PEREIRA Kelly	POR

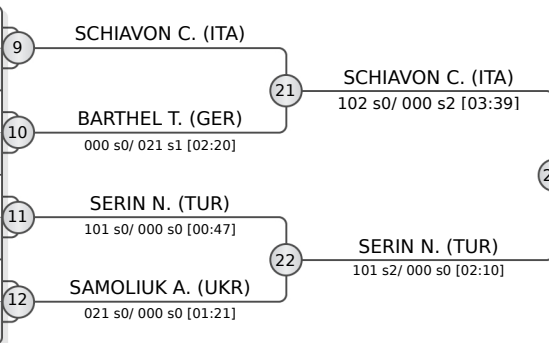

POOL D

AJDUKOVIC Antea	CRO
MAGASSA FOFANA Sogona	ESP
PRUESSE Elina	GER
EININGE Saule	LTU
DJEDIAT Imen	SUI
PODZEMNA Zuzana	CZE

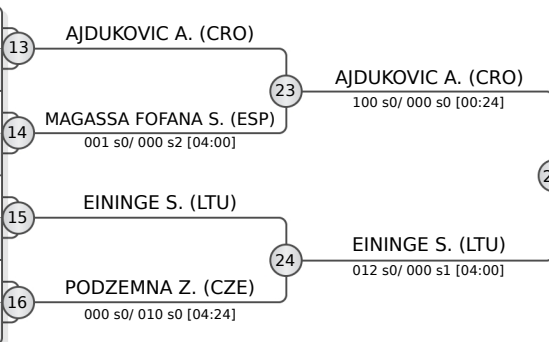

REPECHAGE

HVALEC K. (SLO)	29
COULIBALY TOURE B. (ESP)	30
VAN DRIEL N. (NED)	31
BARTHEL T. (GER)	32
MAGASSA FOFANA S. (ESP)	33

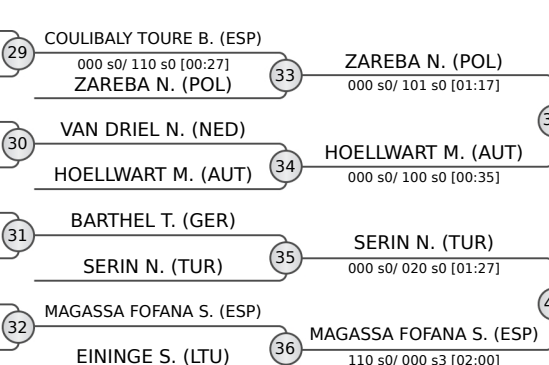

FINAL RESULTS	
1. AJDUKOVIC Antea	CRO
2. DILGER Elina	GER
3. ZAREBA Nikola	POL
3. SACKO Astan	FRA
5. SCHIAVON Carlotta	ITA
5. SERIN Nisanur	TUR
7. HOELLWART Michaela	AUT
7. MAGASSA FOFANA Sogona	ESP