



Berlin Millennium Team Cadet European Cup 2026

Germany, Berlin, 25-26 Apr 2026

-50 kg

Cadets (50)

POOL A

| | | | | |
|----|--------------------------|-----|----|--------------------------|
| 1 | GAT MUALEM Hillel | ISR | 1 | GAT MUALEM H. (ISR) |
| 2 | FOTA Mina Robin | ROU | 33 | CABEZAS SEVILLA V. (ESP) |
| 3 | CABEZAS SEVILLA Victor | ESP | 34 | ZUBETS R. (EST) |
| 4 | GAFFARLI Ali | GER | 35 | ROLNICKI A. (ISR) |
| 5 | GEUNS Gust | BEL | 36 | LAHRIFI M. (FRA) |
| 6 | ZUBETS Rodion | EST | 37 | DOGRU S. (TUR) |
| 7 | SEGUIN Louie | GBR | 38 | LOPEZ PEREIRA H. (ESP) |
| 8 | ROLNICKI Alon | ISR | 39 | ABDUVAKHOBOV M. (UZB) |
| 9 | MATANOVIC Luka | SRB | 40 | MAMATOV A. (KGZ) |
| 10 | POELSTRA Ferron | NED | 41 | DOBROVOLSKIS M. (LTU) |
| 11 | MUNTEANU Ruslan | MDA | 42 | MOUSSAID M. (BEL) |
| 12 | SPURK Paul | GER | 43 | RAHMANI N. (ISR) |
| 13 | LAHRIFI Moulay-Mountasir | FRA | 44 | MAMETYEY R. (GER) |

POOL B

| | | | | |
|----|-----------------------|-----|----|------------------------|
| 9 | DOGRU Suleyman | TUR | 37 | DOGRU S. (TUR) |
| 10 | ILCHEV Martin | BUL | 38 | LOPEZ PEREIRA H. (ESP) |
| 11 | PATZ John-Lukas | GER | 39 | ABDUVAKHOBOV M. (UZB) |
| 12 | JASAITIS Rokas | LTU | 40 | MAMATOV A. (KGZ) |
| 13 | LOPEZ PEREIRA Hugo | ESP | 41 | DOBROVOLSKIS M. (LTU) |
| 14 | KOSLAEV Muhammad | AUT | 42 | MOUSSAID M. (BEL) |
| 15 | ABDUVAKHOBOV Mamurjon | UZB | 43 | RAHMANI N. (ISR) |
| 16 | PALMAERTS Jolan | BEL | 44 | MAMETYEY R. (GER) |
| 17 | KRETZSCHMAR Dwayne | GER | 45 | ASIK T. (TUR) |
| 18 | MAST Tom | ISR | 46 | BLASCO PEREZ I. (ESP) |
| 19 | ALVES Andre Henrique | POR | 47 | STOLAKIS M. (GER) |
| 20 | MAMATOV Ariet | KGZ | 48 | SCHMIDT C. (GER) |

POOL C

| | | | | |
|----|---------------------|-----|----|-----------------------|
| 17 | HEIMANS Klaas | NED | 41 | DOBROVOLSKIS M. (LTU) |
| 18 | TANASI Sando | LAT | 42 | MOUSSAID M. (BEL) |
| 19 | DOBROVOLSKIS Mantas | LTU | 43 | RAHMANI N. (ISR) |
| 20 | NAKASH Itai | ISR | 44 | MAMETYEY R. (GER) |
| 21 | MOUSSAID Mehdi | BEL | 45 | ASIK T. (TUR) |
| 22 | DAVYDOV Henry | GER | 46 | BLASCO PEREZ I. (ESP) |
| 23 | YAGUE LANCHA Ruben | ESP | 47 | STOLAKIS M. (GER) |
| 24 | SOUKUP Matyas | CZE | 48 | SCHMIDT C. (GER) |
| 25 | RAHMANI Noam | ISR | 49 | GAFFARLI A. (GER) |
| 26 | BERNUZ Hugo | FRA | 50 | LAHRIFI M. (FRA) |
| 27 | MURTAZALIEV Samad | AUT | 51 | DOGRU S. (TUR) |
| 28 | ISHENALIEV Syimyk | KGZ | 52 | ABDUVAKHOBOV M. (UZB) |
| 29 | MAMETYEY Roman | GER | 53 | DOBROVOLSKIS M. (LTU) |

POOL D

| | | | | |
|----|-----------------------------|-----|----|-----------------------|
| 25 | KELLER Aaron Joshua | GER | 45 | KELLER A. (GER) |
| 26 | MINZAT Marius | MDA | 46 | BLASCO PEREZ I. (ESP) |
| 27 | ASIK Taha Baran | TUR | 47 | STOLAKIS M. (GER) |
| 28 | LEVINGER Ehud | ISR | 48 | SCHMIDT C. (GER) |
| 29 | DEWULF Lorn | BEL | 49 | GAFFARLI A. (GER) |
| 30 | BLASCO PEREZ Imanol | ESP | 50 | LAHRIFI M. (FRA) |
| 31 | STOLAKIS Mariano | GER | 51 | DOGRU S. (TUR) |
| 32 | QUINTINO Armando | POR | 52 | ABDUVAKHOBOV M. (UZB) |
| 33 | TUDOR Alin | ROU | 53 | DOBROVOLSKIS M. (LTU) |
| 34 | MAISURADZE Mate | GEO | 54 | MAMETYEY R. (GER) |
| 35 | AGHAYEV Nihad | AZE | 55 | KELLER A. (GER) |
| 36 | SCHMIDT Constantin Matthias | GER | 56 | AGHAYEV N. (AZE) |

REPECHAGE

| | | | |
|----|--------------------|----|--------------------|
| 61 | MUNTEANU R. (MDA) | 65 | ROLNICKI A. (ISR) |
| 62 | PALMAERTS J. (BEL) | 66 | PALMAERTS J. (BEL) |
| 63 | TANASI S. (LAT) | 67 | HEIMANS K. (NED) |
| 64 | SCHMIDT C. (GER) | 68 | STOLAKIS M. (GER) |

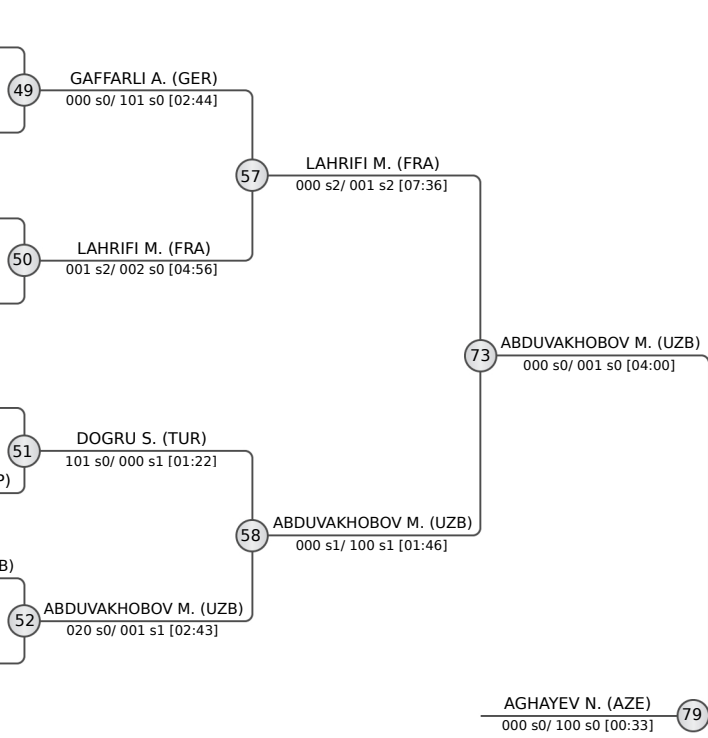



Berlin Millennium Team Cadet European Cup 2026

Germany, Berlin, 25-26 Apr 2026

-55 kg

Cadets (63)

POOL A

| | | | |
|----|------------------------------|---|-----------------------|
| 1 | UYAR Celil (NED) | 1 | UYAR C. (NED) |
| 2 | LEUPOLD Ansgar Thorben (GER) | 2 | BEN LULU J. (ISR) |
| 3 | BEN LULU Jonathan (ISR) | 3 | KREMER A. (GER) |
| 4 | KREMER Arthur (GER) | 4 | DE LAURENTIS M. (ITA) |
| 5 | DOCHERTY Jack (GBR) | 5 | PICKEL D. (ISR) |
| 6 | BIOSCA GARCIA Renat (ESP) | 6 | KOKKONEN V. (FIN) |
| 7 | DE LAURENTIS Mattia (ITA) | 7 | NOETZEL L. (GER) |
| 8 | PICKEL Daniel (ISR) | 8 | VUSHEV A. (BUL) |
| 9 | SEFSAF Hamza (BEL) | | |
| 10 | KOKKONEN Valtteri (FIN) | | |
| 11 | DREWS Fabian (GER) | | |
| 12 | RACKAUSKAS Ignas (LTU) | | |
| 13 | NOETZEL Linus (GER) | | |
| 14 | SINAGINS Nils (LAT) | | |
| 15 | VUSHEV Aleksandar (BUL) | | |

POOL B

| | | | |
|----|-----------------------------|----|--------------------|
| 9 | KHALILLI Rza (AZE) | 9 | ISMAILOV B. (KGZ) |
| 10 | ISMAILOV Baiel (KGZ) | 10 | TANSINGCO G. (GER) |
| 11 | TANSINGCO Gabryl (GER) | 11 | FUCHS Y. (ISR) |
| 12 | AMARAL Joao (POR) | 12 | GARVE S. (GER) |
| 13 | BROWN Ishmael (GBR) | 13 | TALIBOV I. (AZE) |
| 14 | FUCHS Yuval (ISR) | 14 | PETROSINO E. (ITA) |
| 15 | GARVE Sou (GER) | 15 | GAFFARLI A. (GER) |
| 16 | LEGER VILLA Lucien (FRA) | 16 | ROMI G. (ISR) |
| 17 | TALIBOV Ibrahim (AZE) | | |
| 18 | PANDAY Diego (NED) | | |
| 19 | KURBANOV Djamil (AUT) | | |
| 20 | PETROSINO Errico (ITA) | | |
| 21 | GAFFARLI Al-Hasan (GER) | | |
| 22 | OLARASU Constantin (MDA) | | |
| 23 | ROMI Guy (ISR) | | |
| 24 | LEMONS RODRIGUEZ Omar (ESP) | | |

POOL C

| | | | |
|----|---------------------------|----|----------------------|
| 17 | SHREBERK Guy (ISR) | 17 | SHREBERK G. (ISR) |
| 18 | EVERS Fynn (GER) | 18 | KHUDIYEV F. (AZE) |
| 19 | KHUDIYEV Farid (AZE) | 19 | BLACKSHAW R. (GBR) |
| 20 | ZIRAKASHVILI Merabi (GEO) | 20 | KAMCHYBEKOV Y. (KGZ) |
| 21 | BLACKSHAW Reece (GBR) | 21 | SHVARTS A. (ISR) |
| 22 | BARAK Davor (GER) | 22 | LASICA A. (CRO) |
| 23 | HILARIO Rodrigo (POR) | 23 | DOUINE M. (ITA) |
| 24 | KAMCHYBEKOV Yiman (KGZ) | 24 | MANSUR X. (NED) |
| 25 | SHVARTS Amit (ISR) | | |
| 26 | VLAD Sorin (ROU) | | |
| 27 | VUSHEV Mihail (BUL) | | |
| 28 | LASICA Andrej (CRO) | | |
| 29 | TABACHNIK Liam (ISR) | | |
| 30 | DOUINE Matteo (ITA) | | |
| 31 | MANSUR Xavio (NED) | | |
| 32 | PETROV Stephan (GER) | | |

POOL D

| | | | |
|----|------------------------------------|----|-----------------------|
| 25 | YUSUPOV Bobur (UZB) | 25 | YUSUPOV B. (UZB) |
| 26 | SILEN Topi (FIN) | 26 | IEVINS M. (LAT) |
| 27 | BERMAN Shayan (ISR) | 27 | JAKL M. (CZE) |
| 28 | IEVINS Martins (LAT) | 28 | FELLOUKA L. (CYP) |
| 29 | JAKL Marek (CZE) | 29 | FELLOUKA Loizos (CYP) |
| 30 | MUELLER Andrej (GER) | 30 | ASILBEKOV R. (KGZ) |
| 31 | HUNTER Luke (GBR) | 31 | HARDT C. (GER) |
| 32 | FELLOUKA Loizos (CYP) | 32 | TARASOV A. (ISR) |
| 33 | USMONOV Shokhjakhon (UZB) | 33 | BAUER E. (GER) |
| 34 | ASILBEKOV Ramis Stalbekovich (KGZ) | | |
| 35 | HARDT Constantin (GER) | | |
| 36 | JOERGENSEN Romeo (DEN) | | |
| 37 | RHODES Lewis (GBR) | | |
| 38 | TARASOV Aleksander (ISR) | | |
| 39 | LLENA CARDIL Ivan (ESP) | | |
| 40 | BAUER Eddie (GER) | | |

REPECHAGE

| | | | |
|----|-----------------------|----|--------------------|
| 61 | BEN LULU J. (ISR) | 61 | BEN LULU J. (ISR) |
| 62 | PANDAY D. (NED) | 62 | PETROSINO E. (ITA) |
| 63 | PETROSINO E. (ITA) | 63 | SHREBERK G. (ISR) |
| 64 | ZIRAKASHVILI M. (GEO) | 64 | SILEN T. (FIN) |
| 65 | DE LAURENTIS M. (ITA) | 65 | JAKL M. (CZE) |
| 66 | PETROSINO E. (ITA) | 66 | ASILBEKOV R. (KGZ) |
| 67 | SHREBERK G. (ISR) | 67 | SHREBERK G. (ISR) |
| 68 | SILEN T. (FIN) | 68 | ASILBEKOV R. (KGZ) |
| 69 | DE LAURENTIS M. (ITA) | 69 | PICKEL D. (ISR) |
| 70 | PETROSINO E. (ITA) | 70 | PETROSINO E. (ITA) |
| 71 | SHREBERK G. (ISR) | 71 | SHREBERK G. (ISR) |
| 72 | JAKL M. (CZE) | 72 | ASILBEKOV R. (KGZ) |
| 73 | TALIBOV I. (AZE) | 73 | TALIBOV I. (AZE) |
| 74 | KHUDIYEV F. (AZE) | 74 | KHUDIYEV F. (AZE) |
| 75 | PETROSINO E. (ITA) | 75 | PETROSINO E. (ITA) |
| 76 | SHREBERK G. (ISR) | 76 | SHREBERK G. (ISR) |
| 77 | YUSUPOV B. (UZB) | 77 | YUSUPOV B. (UZB) |
| 78 | UYAR C. (NED) | 78 | UYAR C. (NED) |

| FINAL RESULTS | | |
|---------------|------------------------------|-----|
| 1. | KHUDIYEV Farid | AZE |
| 2. | TALIBOV Ibrahim | AZE |
| 3. | UYAR Celil | NED |
| 3. | PETROSINO Errico | ITA |
| 5. | SHREBERK Guy | ISR |
| 7. | PICKEL Daniel | ISR |
| 7. | ASILBEKOV Ramis Stalbekovich | KGZ |





Berlin Millennium Team Cadet European Cup 2026

Germany, Berlin, 25-26 Apr 2026

-60 kg

Cadets (89)

POOL A

| | | | | |
|--|----------------------------------|-----|----|------------------------------|
| | CORI Timeo | SUI | 1 | CORI T. (SUI) |
| | PUSEY Stanley | GBR | 2 | SCHREURS P. (NED) |
| | SCHREURS Pim | NED | | 001 s0/ 002 s0 [04:00] |
| | PLUHATYROV Roman | GER | 3 | DASKAL E. (ISR) |
| | DASKAL Eyal | ISR | | 000 s0/ 012 s0 [04:00] |
| | HRISTOV Emo | BUL | 4 | HRISTOV E. (BUL) |
| | ZYCHLINSKI Ide | ISR | 5 | ZYCHLINSKI I. (ISR) |
| | LAZORKINS Timofejs | LAT | 6 | LAZORKINS T. (LAT) |
| | MEZHIEV Rasul | GER | 7 | MEZHIEV R. (GER) |
| | KOLOSSOV Kristo | EST | | 013 s0/ 010 s0 [04:00] |
| | BISTRICEANU Luca | ROU | 8 | BISTRICEANU L. (ROU) |
| | CARABOTTO Gabriele | ITA | 9 | CARABOTTO G. (ITA) |
| | BLAZHKO Oleksandr | AUT | 10 | BLAZHKO O. (AUT) |
| | USINASHVILI Andro | GEO | 11 | USINASHVILI A. (GEO) |
| | CABECANA Phil | GER | | 100 s0/ 000 s0 [05:17] |
| | FILISTOVICH Maksim | SWE | 12 | FILISTOVICH M. (SWE) |
| | BURLACU CACALETEANU Vlad Andreas | ESP | 13 | BURLACU CACALETEANU V. (ESP) |
| | PINTRIJEL David | ROU | | 100 s0/ 000 s0 [04:49] |
| | RAIDOS Aristotelis | GER | 14 | RAIDOS A. (GER) |
| | GOLUBOVSKIJ Liutauras | LTU | 15 | PAULA L. (POR) |
| | PAULA Lourenco | POR | | 000 s0/ 100 s0 [01:08] |
| | WINKLER Inbar | ISR | 16 | WINKLER I. (ISR) |
| | | | | 001 s0/ 100 s1 [03:29] |

POOL B

| | | | | |
|--|----------------------|-----|----|------------------------|
| | GUR Ramazan Aykut | TUR | 17 | GUR R. (TUR) |
| | ASGAROV Mehman | AZE | 18 | ASGAROV M. (AZE) |
| | LUTZ Georgij | GER | | 100 s0/ 000 s3 [03:39] |
| | SAMARTZIDIS Sergios | AUT | 19 | SAMARTZIDIS S. (AUT) |
| | CAVALJI Serghei | CZE | | 100 s0/ 000 s0 [00:31] |
| | HENSSENS Noah | BEL | 20 | HENSSENS N. (BEL) |
| | KASIS Noam | ISR | 21 | KASIS N. (ISR) |
| | DAMIAN Veaceslav | ROU | | 100 s0/ 000 s0 [00:50] |
| | GALIMZHANOV Kainazar | KGZ | 22 | GALIMZHANOV K. (KGZ) |
| | MONTES OLIVA Lucas | ESP | 23 | NICOLAS T. (FRA) |
| | NICOLAS Thibault | FRA | | 000 s0/ 101 s0 [02:01] |
| | SCHUBERT Moritz | GER | 24 | SCHUBERT M. (GER) |
| | KOSTOEV Adam | SWE | 25 | KOSTOEV A. (SWE) |
| | LOKK Dmitriy | GER | 26 | SATTOROV A. (UZB) |
| | SATTOROV Abubakr | UZB | | 000 s2/ 020 s0 [03:04] |
| | LOWENSTERN Nadav | ISR | 27 | LOWENSTERN N. (ISR) |
| | HOFFMANN Linus | GER | | 100 s0/ 000 s0 [00:09] |
| | RICHARDSON Michael | GBR | 28 | RICHARDSON M. (GBR) |
| | SCHUMANN Janek Paul | GER | 29 | SLOBODIAN V. (FIN) |
| | SLOBODIAN Vladyslav | FIN | | 000 s0/ 101 s2 [03:37] |
| | MIGUNOV GOMEZ Maksim | ESP | 30 | MIGUNOV GOMEZ M. (ESP) |
| | | | | 000 s3/ 100 s1 [05:02] |
| | MARLAIS Oliver Vlaho | CRO | 31 | MARLAIS O. (CRO) |
| | GOLDSHMIDT Eli | ISR | 32 | GOLDSHMIDT E. (ISR) |
| | | | | 000 s1/ 100 s0 [01:28] |

REPECHAGE

| | | | | |
|--|----------------------|----|----|------------------------------|
| | CABECANA P. (GER) | | | CABECANA P. (GER) |
| | FILISTOVICH M. (SWE) | 12 | | CARABOTTO G. (ITA) |
| | | | 12 | CARABOTTO G. (ITA) |
| | LOKK D. (GER) | | | WINKLER I. (ISR) |
| | KOSTOEV A. (SWE) | 12 | | KOSTOEV A. (SWE) |
| | | | 13 | RICHARDSON M. (GBR) |
| | OSTERBERG S. (SWE) | | | GOLDSHMIDT E. (ISR) |
| | MILIC M. (MNE) | 12 | | OSTERBERG S. (SWE) |
| | | | 13 | GROSS I. (ISR) |
| | GELBAR D. (ISR) | | | GROSS I. (ISR) |
| | | | 13 | CERVINSKIS B. (LAT) |
| | MIHUT S. (ROU) | 12 | | GELBAR D. (ISR) |
| | | | 13 | GROMYK D. (GER) |
| | | | | GROMYK D. (GER) |
| | | | | SANCES TURON M. (ESP) |
| | | | | SANCES TURON M. (ESP) |
| | | | | CHIARRONI CUITILLAS A. (ESP) |

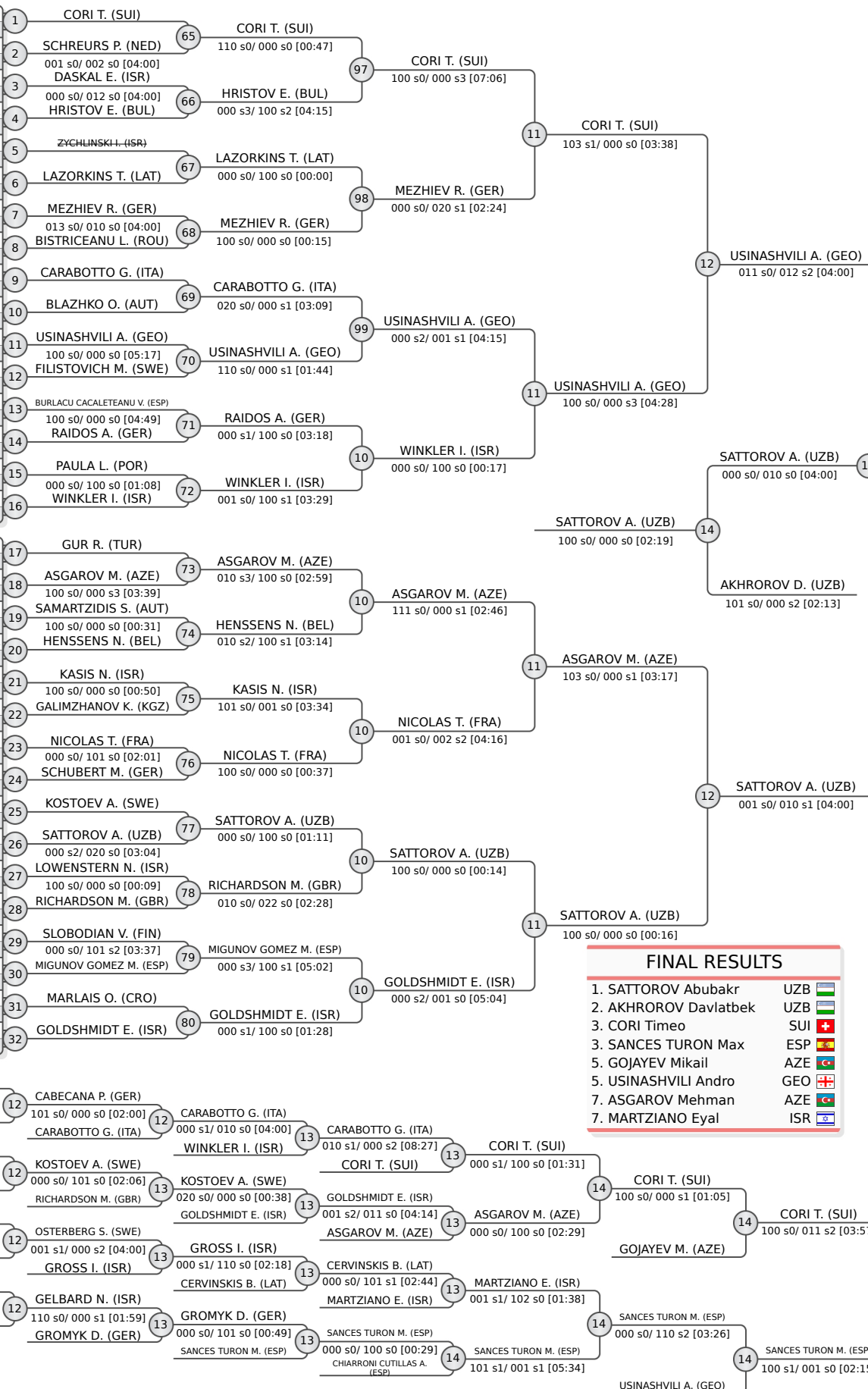

| FINAL RESULTS | |
|-----------------------|-----|
| 1. SATTOROV Abubakr | UZB |
| 2. AKHROROV Davlatbek | UZB |
| 3. CORI Timeo | SUI |
| 5. SANCES TURON Max | ESP |
| 5. GOJAYEV Mikail | AZE |
| 7. USINASHVILI Andro | GEO |
| 7. ASGAROV Mehman | AZE |
| 7. MARTZIANO Eyal | ISR |





Berlin Millennium Team Cadet European Cup 2026

Germany, Berlin, 25-26 Apr 2026

-60 kg

Cadets (89)

POOL C

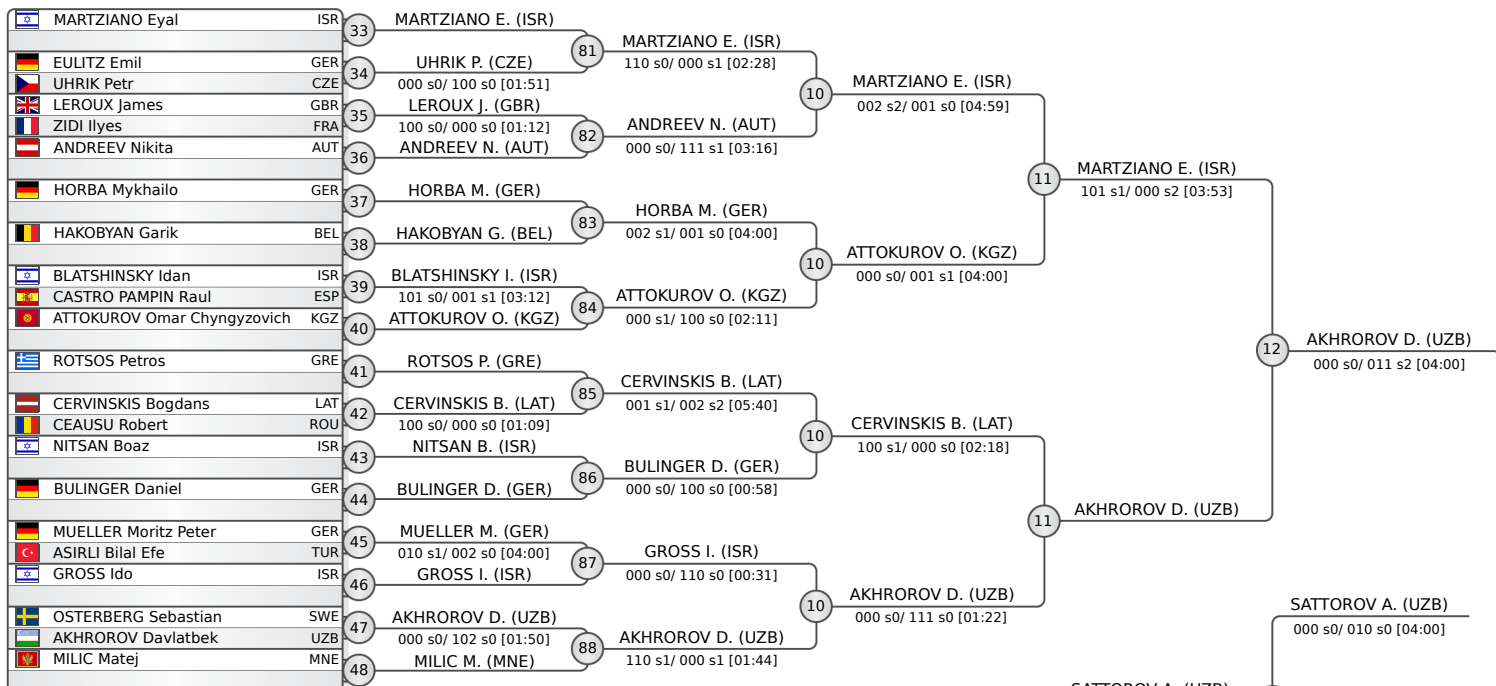

POOL D

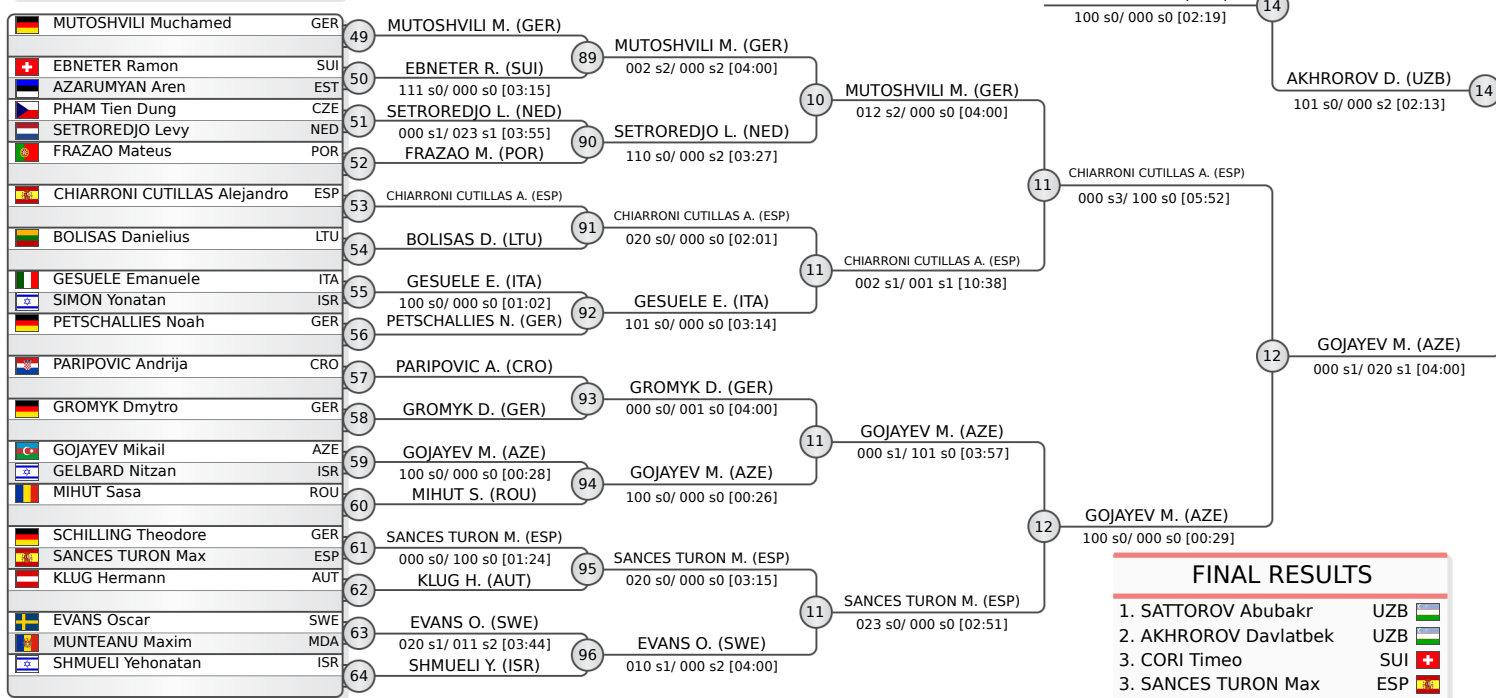

| FINAL RESULTS | | |
|---------------|--------------------|-----|
| 1. | SATTOROV Abubakr | UZB |
| 2. | AKHROROV Davlatbek | UZB |
| 3. | CORI Timeo | SUI |
| 5. | SANCES TURON Max | ESP |
| 5. | GOJAYEV Mikail | AZE |
| 7. | ASGAROV Mehman | AZE |
| 7. | MARTZIANO Eyal | ISR |

REPECHAGE

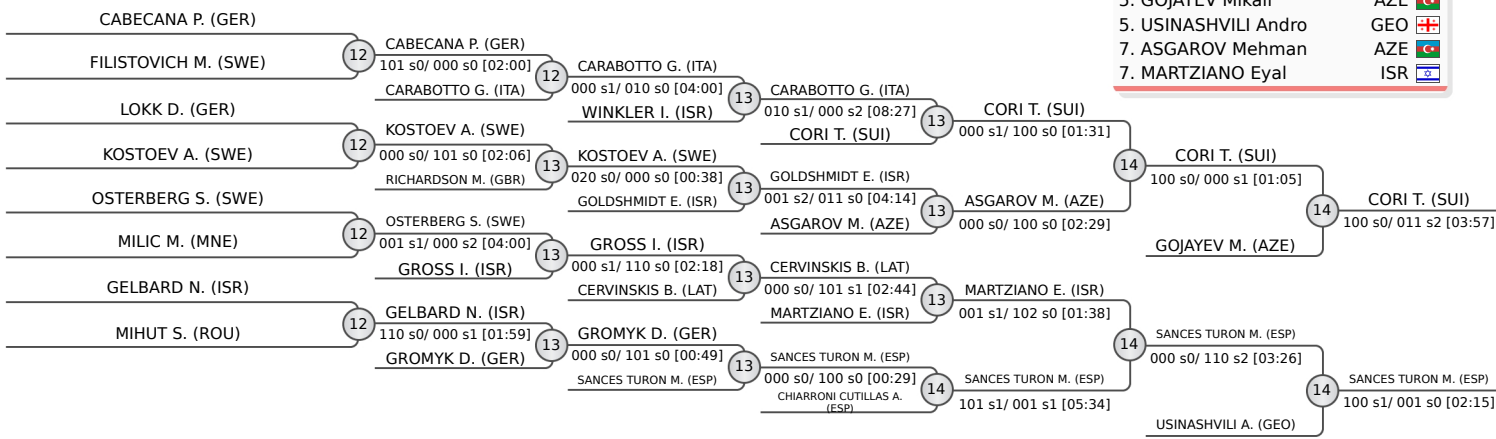



Berlin Millennium Team Cadet European Cup 2026

Germany, Berlin, 25-26 Apr 2026

-66 kg

Cadets (76)

POOL A

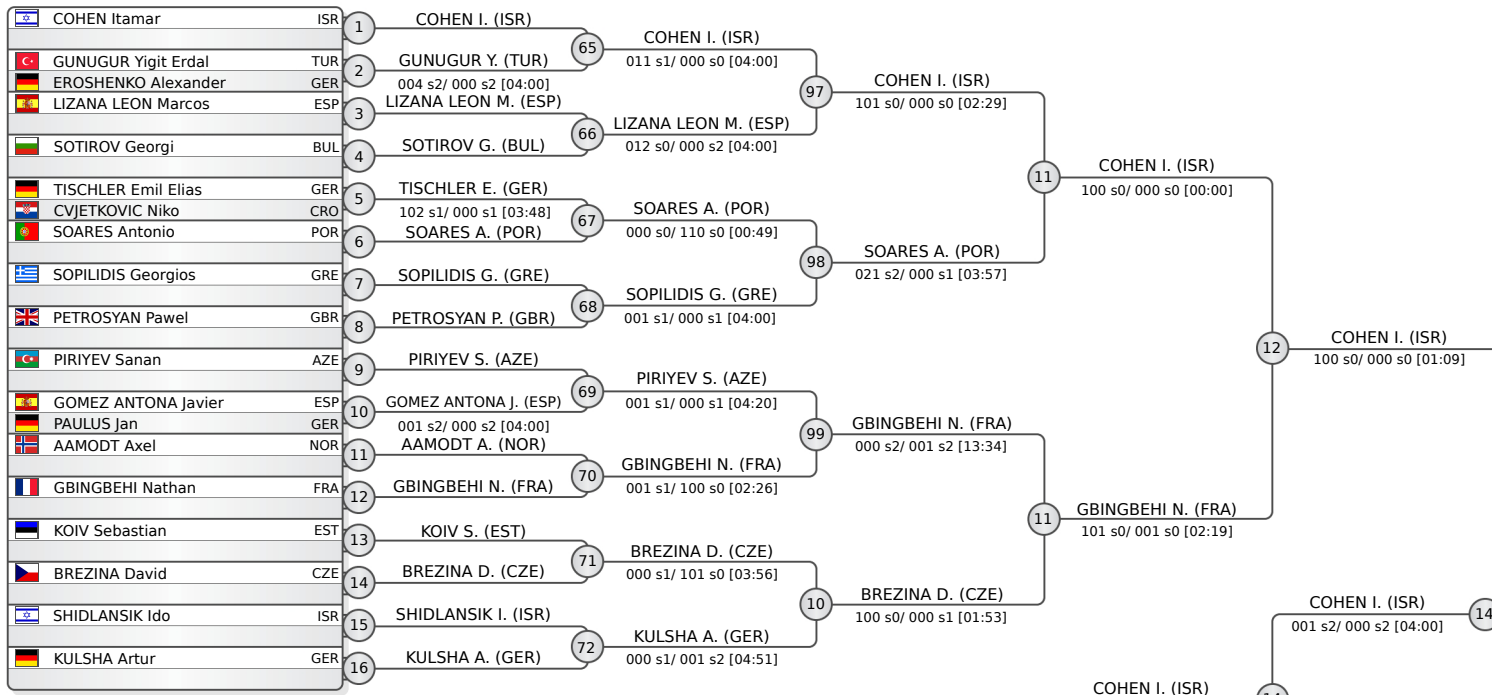

POOL B

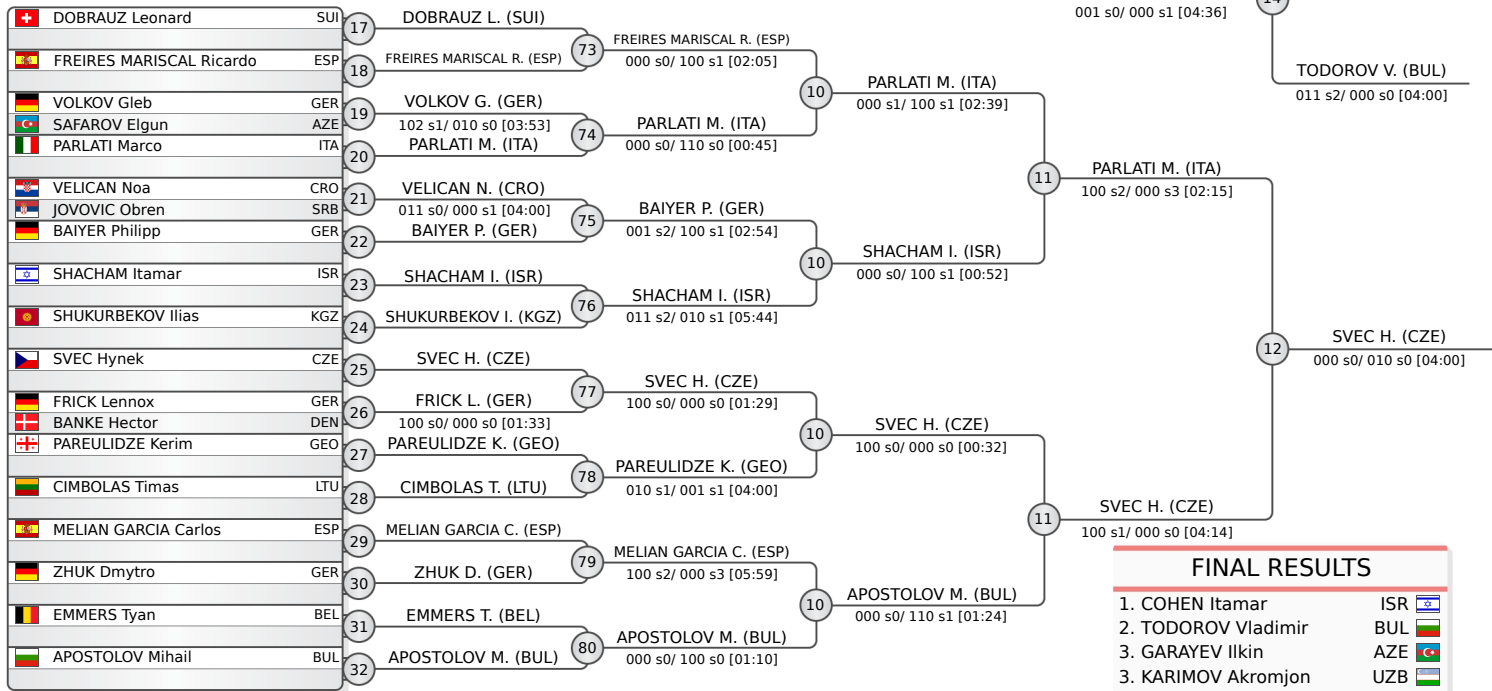

| FINAL RESULTS | |
|------------------------|-----|
| 1. COHEN Itamar | ISR |
| 2. TODOROV Vladimir | BUL |
| 3. GARAYEV Ilkin | AZE |
| 5. KARIMOV Akromjon | UZB |
| 5. PARLATI Marco | ITA |
| 5. SVEC Hynek | CZE |
| 7. GBINGBEHI Nathan | FRA |
| 7. ATAMANIUK Rostyslav | GER |

REPECHAGE

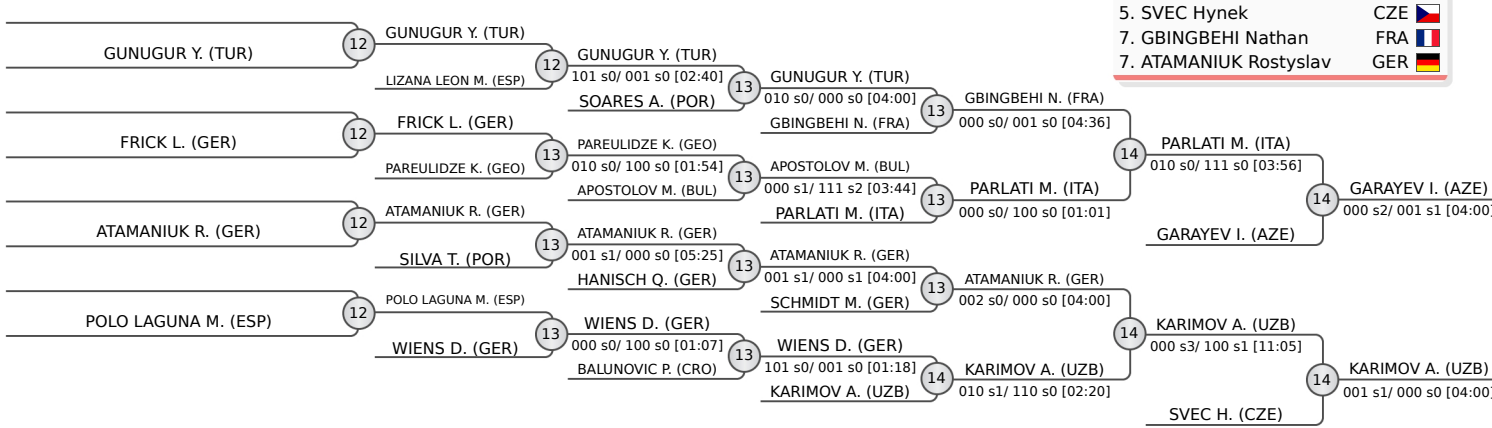



Berlin Millennium Team Cadet European Cup 2026

Germany, Berlin, 25-26 Apr 2026

-66 kg

Cadets (76)

POOL C

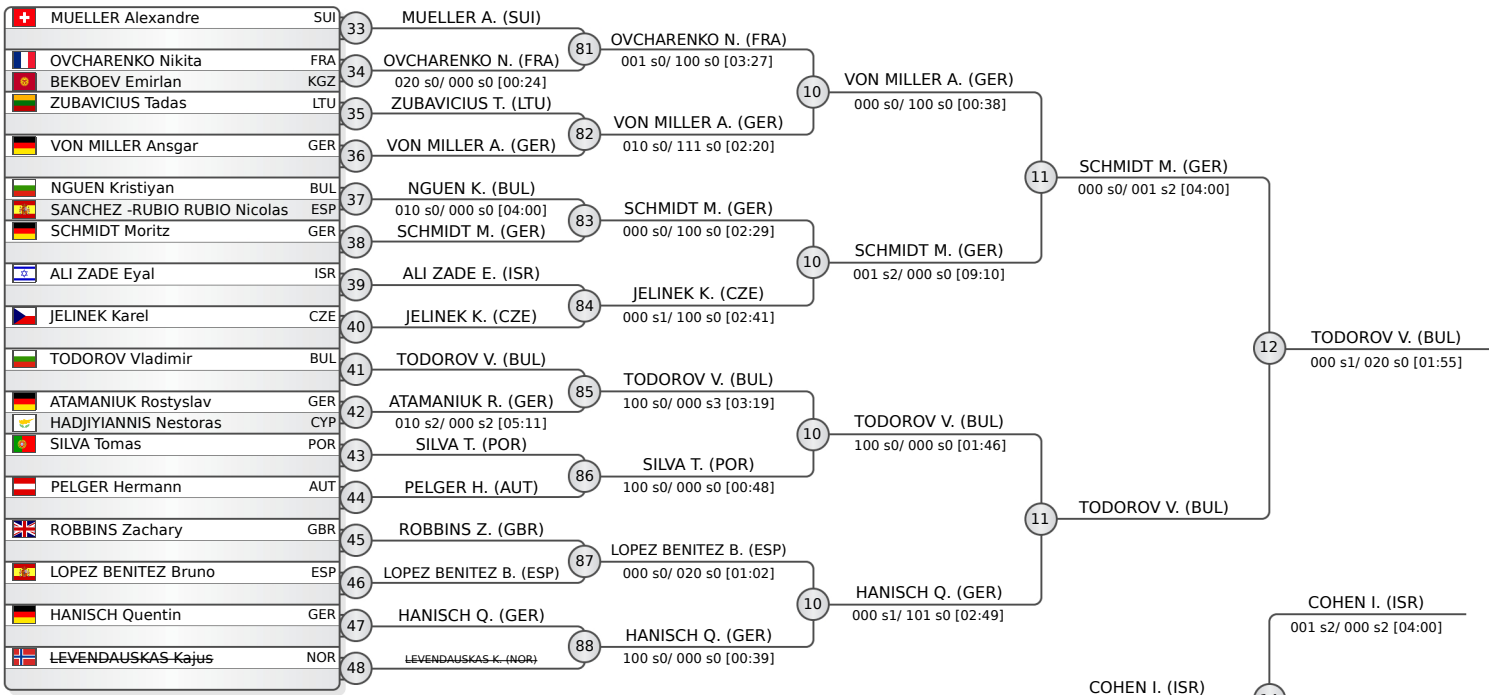

POOL D

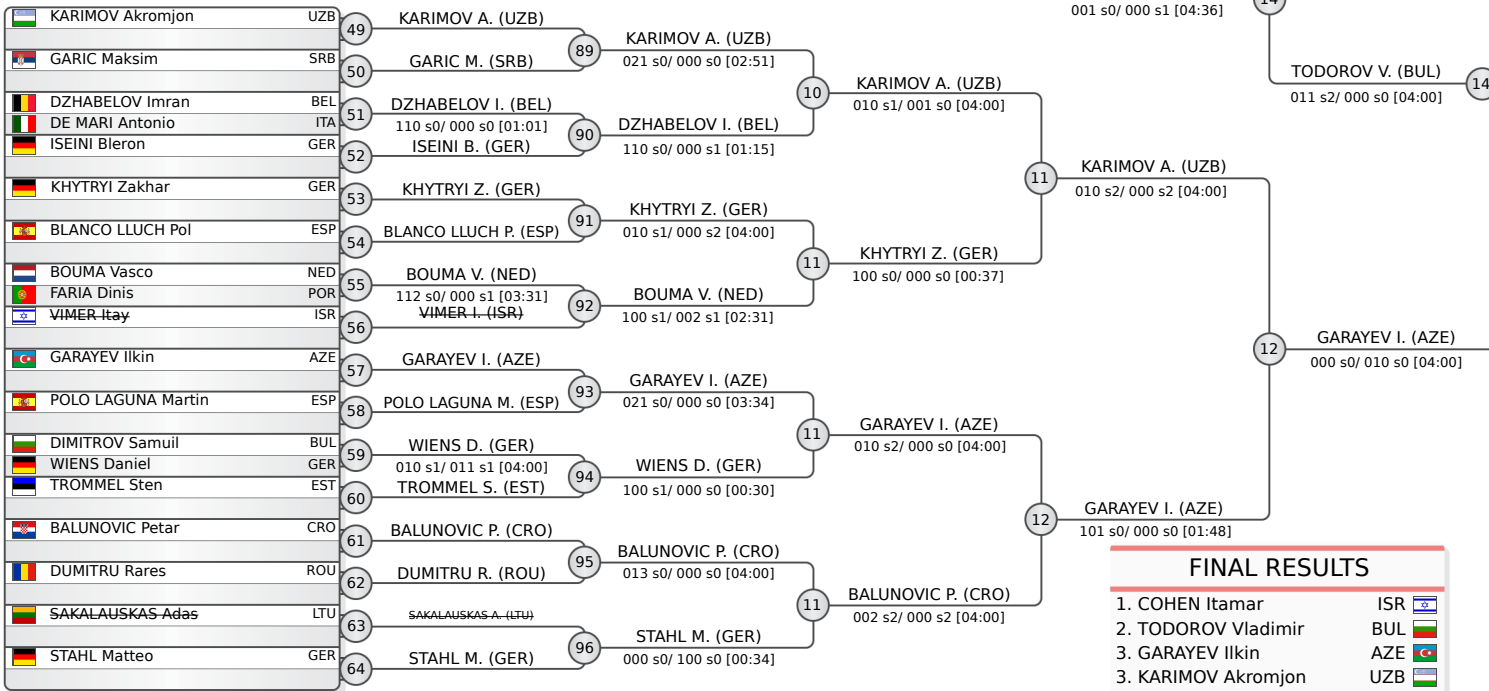

| FINAL RESULTS | | |
|---------------|---------------------|-----|
| 1. | COHEN Itamar | ISR |
| 2. | TODOROV Vladimir | BUL |
| 3. | GARAYEV Ilkin | AZE |
| 4. | KARIMOV Akromjon | UZB |
| 5. | PARLATI Marco | ITA |
| 6. | SVEC Hynek | CZE |
| 7. | GBINGBEHI Nathan | FRA |
| 7. | ATAMANIUK Rostyslav | GER |

REPECHAGE

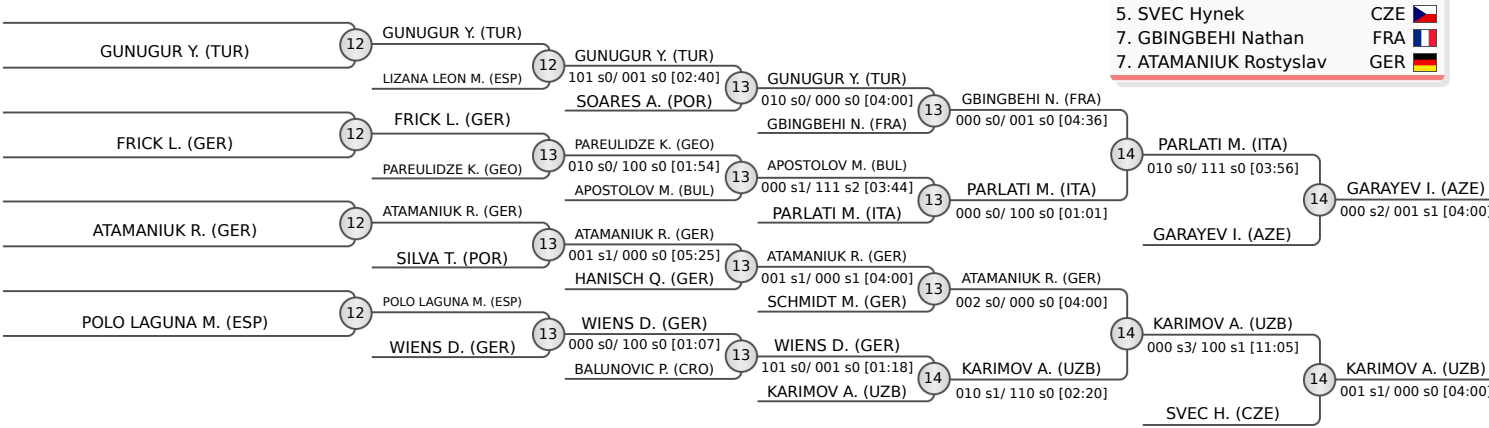



Berlin Millennium Team Cadet European Cup 2026

Germany, Berlin, 25-26 Apr 2026

-73 kg

Cadets (62)

POOL A

| | | | | |
|------------------------------|---|----------------------|------------------------|------------------------|
| RUSNAK Adam (CZE) | 1 | RUSNAK A. (CZE) | 33 | RUSNAK A. (CZE) |
| KUTSON Kristjan (EST) | 2 | BOGAERT I. (BEL) | 000 s1/ 010 s1 [06:20] | 010 s1/ 000 s1 [04:00] |
| BOGAERT Ilkay (BEL) | 2 | MEYARA T. (ISR) | 000 s1/ 011 s0 [04:00] | 49 |
| SCHERPING Maxim (GER) | 3 | REUTFORS V. (SWE) | 000 s1/ 100 s1 [04:00] | 34 |
| MEYARA Tom (ISR) | 3 | REUTFORS V. (SWE) | 100 s0/ 000 s0 [02:30] | 57 |
| REUTFORS Valter (SWE) | 4 | MATUZNYI D. (GER) | 110 s0/ 000 s0 [02:29] | 35 |
| KNEZEVIC Filip (MNE) | 5 | CECI E. (ITA) | 101 s0/ 000 s0 [01:19] | 50 |
| MATUZNYI Dmytro (GER) | 5 | TOSHPULOTOV D. (GER) | 010 s0/ 011 s0 [04:11] | 36 |
| HREN Adrian (CRO) | 6 | MITOI S. (ROU) | 100 s0/ 000 s1 [01:45] | 51 |
| CECI Emiliano (ITA) | 6 | | | |
| MOR Nehoray (ISR) | 7 | | | |
| VOZAR Robert (GBR) | 7 | | | |
| TOSHPULOTOV Daler (GER) | 7 | | | |
| MITOI Stefan (ROU) | 8 | | | |
| MARRERO TEJERA Yeremay (ESP) | 8 | | | |

POOL B

| | | | | | | | | | | | | | | | | |
|----------------------------|----|---------------------------|------------------------|----|-------------------------|------------------------|----|------------------------|------------------------|----|-------------------------|------------------------|----|-------------------|------------------------|----|
| HRISTOFOROV Bruno (EST) | 9 | KILADZE L. (GER) | 000 s0/ 100 s2 [03:08] | 37 | KILADZE L. (GER) | 020 s0/ 000 s0 [01:39] | 51 | KILADZE L. (GER) | 100 s0/ 000 s0 [01:17] | 58 | KILADZE L. (GER) | 110 s0/ 000 s1 [01:51] | 73 | MATUZNYI D. (GER) | 100 s0/ 000 s1 [02:16] | 79 |
| KILADZE Lazare (GER) | 9 | DOKOV K. (BUL) | 100 s0/ 000 s0 [00:30] | 38 | GILAD I. (ISR) | 111 s1/ 000 s1 [03:45] | 38 | GILAD I. (ISR) | 100 s0/ 000 s0 [01:03] | 52 | EXMELIN E. (FRA) | 001 s0/ 101 s0 [02:20] | | | | |
| DOKOV Kiril (BUL) | 10 | NAZAR Y. (AZE) | 012 s2/ 000 s2 [04:00] | 39 | KOKOEV KOKOEV B. (ESP) | 000 s0/ 100 s2 [02:10] | 39 | KOKOEV KOKOEV B. (ESP) | 000 s0/ 100 s2 [02:10] | 52 | EXMELIN E. (FRA) | 001 s0/ 101 s0 [02:20] | | | | |
| MARTON Medard (ROU) | 10 | KURTUMEROV Edem (GER) | 002 s1/ 000 s0 [04:00] | 40 | EXMELIN E. (FRA) | 000 s0/ 100 s0 [01:42] | 40 | EXMELIN E. (FRA) | 021 s0/ 000 s1 [03:32] | 40 | MEDER-KURTOVIC L. (AUT) | 110 s0/ 000 s0 [03:31] | | | | |
| GILAD Itay (ISR) | 11 | KURGHINYAN Misha (NED) | 002 s1/ 000 s0 [04:00] | 40 | MEDER-KURTOVIC L. (AUT) | 110 s0/ 000 s0 [03:31] | 40 | | | | | | | | | |
| SANTOS Samuel (POR) | 11 | AGRONOV Idan (ISR) | 000 s0/ 100 s0 [01:42] | 40 | | | | | | | | | | | | |
| PAUSKIC Silas (DEN) | 12 | EXMELIN Elyes (FRA) | 000 s0/ 100 s0 [01:42] | 40 | | | | | | | | | | | | |
| HOVEN Max Theodor (NOR) | 12 | MEDER-KURTOVIC Leon (AUT) | 110 s0/ 000 s0 [03:31] | 40 | | | | | | | | | | | | |
| NAZAR Yusuf (AZE) | 13 | SCHUSTER Marek (GER) | 110 s0/ 000 s0 [03:31] | 40 | | | | | | | | | | | | |
| KURTUMEROV Edem (GER) | 13 | | | | | | | | | | | | | | | |
| KOKOEV KOKOEV Batraz (ESP) | 14 | | | | | | | | | | | | | | | |
| KURGHINYAN Misha (NED) | 14 | | | | | | | | | | | | | | | |
| AGRONOV Idan (ISR) | 15 | | | | | | | | | | | | | | | |
| EXMELIN Elyes (FRA) | 15 | | | | | | | | | | | | | | | |
| MEDER-KURTOVIC Leon (AUT) | 16 | | | | | | | | | | | | | | | |
| SCHUSTER Marek (GER) | 16 | | | | | | | | | | | | | | | |

POOL C

| | | | | | | | | | | | | | | | | |
|--------------------------|----|---------------------|------------------------|----|---------------------|------------------------|----|---------------------|------------------------|----|-------------------|------------------------|----|-------------------|------------------------|----|
| NOGES Georg (EST) | 17 | NOGES G. (EST) | 010 s0/ 000 s0 [04:00] | 41 | NOGES G. (EST) | 010 s0/ 000 s0 [04:00] | 53 | STOEGMANN S. (AUT) | 010 s1/ 020 s2 [06:37] | 59 | MAMMADOV S. (AZE) | 010 s2/ 022 s0 [03:27] | 74 | MAMMADOV S. (AZE) | 110 s0/ 000 s0 [02:06] | 79 |
| LENNON Cole (GBR) | 18 | SARZHANOV K. (KGZ) | 000 s0/ 111 s0 [01:02] | 41 | SARZHANOV K. (KGZ) | 000 s0/ 111 s0 [01:02] | 53 | STOEGMANN S. (AUT) | 010 s1/ 020 s2 [06:37] | 59 | MAMMADOV S. (AZE) | 010 s2/ 022 s0 [03:27] | 74 | MAMMADOV S. (AZE) | 110 s0/ 000 s0 [02:06] | 79 |
| SARZHANOV Kaisar (KGZ) | 18 | STOEGMANN S. (AUT) | 101 s0/ 000 s0 [03:23] | 42 | STOEGMANN S. (AUT) | 100 s0/ 000 s0 [00:19] | 42 | STOEGMANN S. (AUT) | 100 s0/ 000 s0 [00:19] | 54 | MAMMADOV S. (AZE) | 011 s1/ 111 s0 [04:30] | | | | |
| STOEGMANN Stefan (AUT) | 19 | NISANOV M. (ISR) | 000 s0/ 020 s1 [03:17] | 43 | STINER N. (ISR) | 020 s0/ 000 s0 [00:36] | 43 | STINER N. (ISR) | 100 s0/ 000 s0 [00:32] | 54 | MAMMADOV S. (AZE) | 011 s1/ 111 s0 [04:30] | | | | |
| MOLIM Mayron (FRA) | 19 | STINER N. (ISR) | 020 s0/ 000 s0 [00:36] | 43 | STINER N. (ISR) | 100 s0/ 000 s0 [00:32] | 43 | STINER N. (ISR) | 100 s0/ 000 s0 [00:32] | 54 | MAMMADOV S. (AZE) | 011 s1/ 111 s0 [04:30] | | | | |
| TSCHERHEIKO Mansur (GER) | 20 | ZHELJAZKOV D. (BUL) | 010 s2/ 002 s0 [04:00] | 43 | ZHELJAZKOV D. (BUL) | 010 s2/ 002 s0 [04:00] | 43 | ZHELJAZKOV D. (BUL) | 010 s2/ 002 s0 [04:00] | 54 | MAMMADOV S. (AZE) | 011 s1/ 111 s0 [04:30] | | | | |
| NISANOV Maxim (ISR) | 20 | SLAVINSKAS R. (LTU) | 100 s0/ 000 s1 [02:20] | 44 | MAMMADOV S. (AZE) | 000 s0/ 100 s0 [01:01] | 44 | MAMMADOV S. (AZE) | 000 s0/ 100 s0 [01:01] | 54 | MAMMADOV S. (AZE) | 011 s1/ 111 s0 [04:30] | | | | |
| STINER Noam (ISR) | 21 | MAMMADOV S. (AZE) | 000 s0/ 100 s0 [01:01] | 44 | MAMMADOV S. (AZE) | 000 s0/ 100 s0 [01:01] | 44 | MAMMADOV S. (AZE) | 000 s0/ 100 s0 [01:01] | 54 | MAMMADOV S. (AZE) | 011 s1/ 111 s0 [04:30] | | | | |
| HANSCHMANN Juri (GER) | 21 | | | | | | | | | | | | | | | |
| ZHELJAZKOV Dimitar (BUL) | 22 | | | | | | | | | | | | | | | |
| STEPINS Valters (LAT) | 22 | | | | | | | | | | | | | | | |
| SLAVINSKAS Reinas (LTU) | 23 | | | | | | | | | | | | | | | |
| KUBITZA Maximilian (GER) | 23 | | | | | | | | | | | | | | | |
| MAMMADOV Sadig (AZE) | 24 | | | | | | | | | | | | | | | |
| STARING Eros (NED) | 24 | | | | | | | | | | | | | | | |

POOL D

| | | | | | | | | | | | | | | | | | | | | | | |
|------------------------------|----|------------------------------|------------------------|----|--------------------------|------------------------|----|--------------------------|------------------------|----|--------------------------|------------------------|----|--------------------------|------------------------|----|--------------------------|------------------------|----|--------------------------|------------------------|----|
| NIKOLCHEV Ivan (BUL) | 25 | NIKOLCHEV I. (BUL) | 011 s1/ 000 s1 [04:00] | 45 | ESSADE A. (SUI) | 000 s0/ 101 s0 [00:53] | 45 | ESSADE A. (SUI) | 000 s0/ 101 s0 [00:53] | 55 | ESSADE A. (SUI) | 100 s0/ 000 s0 [00:36] | 60 | USMONOV B. (UZB) | 000 s2/ 001 s1 [04:00] | 74 | MAMMADOV S. (AZE) | 110 s0/ 000 s0 [02:06] | 79 | | | |
| GOLOVKINS Denis (FRO) | 26 | ESSADE A. (SUI) | 000 s0/ 101 s0 [00:53] | 45 | ESSADE A. (SUI) | 000 s0/ 101 s0 [00:53] | 45 | ESSADE A. (SUI) | 000 s0/ 101 s0 [00:53] | 55 | ESSADE A. (SUI) | 100 s0/ 000 s0 [00:36] | 60 | USMONOV B. (UZB) | 000 s2/ 001 s1 [04:00] | 74 | MAMMADOV S. (AZE) | 110 s0/ 000 s0 [02:06] | 79 | | | |
| ESSADE Antoine (SUI) | 26 | POHLMANN Willi-Balduin (GER) | 110 s2/ 010 s3 [06:44] | 46 | MCALEESE S. (GBR) | 001 s3/ 100 s2 [03:56] | 46 | MCALEESE S. (GBR) | 001 s3/ 100 s2 [03:56] | 55 | ESSADE A. (SUI) | 100 s0/ 000 s0 [00:36] | 60 | USMONOV B. (UZB) | 000 s2/ 001 s1 [04:00] | 74 | MAMMADOV S. (AZE) | 110 s0/ 000 s0 [02:06] | 79 | | | |
| VULETIC Kevin (GER) | 27 | MCALEESE S. (GBR) | 001 s3/ 100 s2 [03:56] | 46 | MCALEESE S. (GBR) | 001 s3/ 100 s2 [03:56] | 46 | MCALEESE S. (GBR) | 001 s3/ 100 s2 [03:56] | 55 | ESSADE A. (SUI) | 100 s0/ 000 s0 [00:36] | 60 | USMONOV B. (UZB) | 000 s2/ 001 s1 [04:00] | 74 | MAMMADOV S. (AZE) | 110 s0/ 000 s0 [02:06] | 79 | | | |
| POHLMANN Willi-Balduin (GER) | 27 | SCHUERER H. (GER) | 020 s0/ 000 s0 [00:51] | 47 | USMONOV B. (UZB) | 000 s1/ 101 s0 [02:30] | 47 | USMONOV B. (UZB) | 000 s1/ 101 s0 [02:30] | 56 | USMONOV B. (UZB) | 100 s0/ 000 s0 [00:39] | 56 | USMONOV B. (UZB) | 100 s0/ 000 s0 [00:39] | 56 | USMONOV B. (UZB) | 000 s2/ 001 s1 [04:00] | 74 | MAMMADOV S. (AZE) | 110 s0/ 000 s0 [02:06] | 79 |
| ALIKHANOV Amir (EST) | 27 | USMONOV B. (UZB) | 000 s1/ 101 s0 [02:30] | 47 | USMONOV B. (UZB) | 000 s1/ 101 s0 [02:30] | 47 | USMONOV B. (UZB) | 000 s1/ 101 s0 [02:30] | 56 | USMONOV B. (UZB) | 100 s0/ 000 s0 [00:39] | 56 | USMONOV B. (UZB) | 100 s0/ 000 s0 [00:39] | 56 | USMONOV B. (UZB) | 000 s2/ 001 s1 [04:00] | 74 | MAMMADOV S. (AZE) | 110 s0/ 000 s0 [02:06] | 79 |
| MURESAN Erik (ROU) | 28 | RAHIMOV K. (AZE) | 010 s0/ 101 s0 [02:00] | 48 | RAHIMOV K. (AZE) | 011 s1/ 002 s2 [04:00] | 48 | RAHIMOV K. (AZE) | 011 s1/ 002 s2 [04:00] | 48 | RAHIMOV K. (AZE) | 011 s1/ 002 s2 [04:00] | 48 | RAHIMOV K. (AZE) | 011 s1/ 002 s2 [04:00] | 48 | RAHIMOV K. (AZE) | 011 s1/ 002 s2 [04:00] | 48 | RAHIMOV K. (AZE) | 011 s1/ 002 s2 [04:00] | 48 |
| MCALEESE Sean (GBR) | 28 | SANUDO SAMPERIO D. (ESP) | 100 s0/ 000 s0 [02:18] | 48 | SANUDO SAMPERIO D. (ESP) | 100 s0/ 000 s0 [02:18] | 48 | SANUDO SAMPERIO D. (ESP) | 100 s0/ 000 s0 [02:18] | 48 | SANUDO SAMPERIO D. (ESP) | 100 s0/ 000 s0 [02:18] | 48 | SANUDO SAMPERIO D. (ESP) | 100 s0/ 000 s0 [02:18] | 48 | SANUDO SAMPERIO D. (ESP) | 100 s0/ 000 s0 [02:18] | 48 | SANUDO SAMPERIO D. (ESP) | 100 s0/ 000 s0 [02:18] | 48 |
| SCHUERER Hannes (GER) | 29 | | | | | | | | | | | | | | | | | | | | | |
| BARBALATA Mario Florin (ITA) | 29 | | | | | | | | | | | | | | | | | | | | | |
| USMONOV Bekhruzbeq (UZB) | 30 | | | | | | | | | | | | | | | | | | | | | |
| VOJVODA Divo (CRO) | 30 | | | | | | | | | | | | | | | | | | | | | |
| STANJA Jonathan (GER) | 31 | | | | | | | | | | | | | | | | | | | | | |
| RAHIMOV Kanan (AZE) | 31 | | | | | | | | | | | | | | | | | | | | | |
| SANUDO SAMPERIO Dario (ESP) | 32 | | | | | | | | | | | | | | | | | | | | | |
| MOLOMAN Sagi (ISR) | 32 | | | | | | | | | | | | | | | | | | | | | |

REPECHAGE

| | | | | | | | | | | | | | | | | | | | |
|----------------------|----|----------------------|------------------------|----|----------------------|------------------------|----|----------------------|------------------------|----|----------------------|------------------------|----|-------------------|------------------------|----|-------------------|------------------------|----|
| HREN A. (CRO) | 61 | CECI E. (ITA) | 000 s1/ 010 s0 [04:00] | 65 | CECI E. (ITA) | 010 s2/ 000 s2 [06:03] | 69 | CECI E. (ITA) | 100 s0/ 000 s0 [00:00] | 75 | HRISTOFOROV B. (EST) | 000 s0/ 100 s0 [01:42] | 77 | USMONOV B. (UZB) | 000 s2/ 001 s1 [04:00] | 79 | | | |
| CECI E. (ITA) | 61 | TOSHPULOTOV D. (GER) | 110 s0/ 000 s0 [00:51] | 65 | RUSNAK A. (CZE) | 010 s2/ 000 s2 [06:03] | 69 | CECI E. (ITA) | 100 s0/ 000 s0 [00:00] | 75 | HRISTOFOROV B. (EST) | 000 s0/ 100 s0 [01:42] | 77 | USMONOV B. (UZB) | 000 s2/ 001 s1 [04:00] | 79 | | | |
| HRISTOFOROV B. (EST) | 62 | HRISTOFOROV B. (EST) | 020 s0/ 000 s1 [04:00] | 66 | HRISTOFOROV B. (EST) | 100 s1/ 000 s1 [03:14] | 70 | HRISTOFOROV B. (EST) | 010 s0/ 000 s1 [04:00] | 76 | STARING E. (NED) | 001 s2/ 000 s0 [09:43] | 78 | STARING E. (NED) | 001 s2/ 000 s0 [09:43] | 78 | | | |
| DOKOV K. (BUL) | 62 | GILAD I. (ISR) | 000 s1/ 100 s0 [01:25] | 66 | EXMELIN E. (FRA) | 010 s0/ 000 s1 [04:00] | 70 | HRISTOFOROV B. (EST) | 010 s0/ 000 s1 [04:00] | 76 | STARING E. (NED) | 001 s2/ 000 s0 [09:43] | 78 | STARING E. (NED) | 001 s2/ 000 s0 [09:43] | 78 | | | |
| STARING E. (NED) | 63 | STARING E. (NED) | 010 s2/ 001 s1 [04:00] | 67 | STARING E. (NED) | 010 s2/ 001 s1 [04:00] | 67 | STARING E. (NED) | 010 s2/ 001 s1 [04:00] | 67 | STARING E. (NED) | 010 s2/ 001 s1 [04:00] | 67 | STARING E. (NED) | 010 s2/ 001 s1 [04:00] | 67 | STARING E. (NED) | 010 s2/ 001 s1 [04:00] | 67 |
| SLAVINSKAS R. (LTU) | 63 | STARING E. (NED) | 010 s2/ 001 s1 [04:00] | 67 | STOEGMANN S. (AUT) | 010 s1/ 000 s2 [08:51] | 71 | STARING E. (NED) | 010 s2/ 001 s1 [04:00] | 67 | STARING E. (NED) | 010 s2/ 001 s1 [04:00] | 67 | STARING E. (NED) | 010 s2/ 001 s1 [04:00] | 67 | STARING E. (NED) | 010 s2/ 001 s1 [04:00] | 67 |
| VOJVODA D. (CRO) | 64 | SCHUERER H. (GER) | 101 s0/ 000 s0 [01:08] | 68 | SCHUERER H. (GER) | 100 s0/ 000 s0 [03:43] | 72 | SCHUERER H. (GER) | 100 s0/ 000 s0 [03:43] | 72 | SCHUERER H. (GER) | 100 s0/ 000 s0 [03:43] | 72 | SCHUERER H. (GER) | 100 s0/ 000 s0 [03:43] | 72 | SCHUERER H. (GER) | 100 s0/ 000 s0 [03:43] | 72 |
| SCHUERER H. (GER) | 64 | RAHIMOV K. (AZE) | 101 s0/ 000 s0 [01:08] | 68 | ESSADE A. (SUI) | 000 s0/ 101 s0 [00:53] | 45 | ESSADE A. (SUI) | 000 s0/ 101 s0 [00:53] | 45 | ESSADE A. (SUI) | 000 s0/ 101 s0 [00:53] | 45 | ESSADE A. (SUI) | 000 s0/ 101 s0 [00:53] | 45 | ESSADE A. (SUI) | 000 s0/ 101 s0 [00:53] | 45 |

FINAL RESULTS

- MATUZNYI Dmytro (GER)
- MAMMADOV Sadig (AZE)
- USMONOV Bekhruzbeq (UZB)
- STARING Eros (NED)
- HRISTOFOROV Bruno (EST)
- KILADZE Lazare (GER)
- CECI Emiliano (ITA)
- SCHUERER Hannes (GER)





Berlin Millennium Team Cadet European Cup 2026

Germany, Berlin, 25-26 Apr 2026

-81 kg

Cadets (59)

POOL A

| | | |
|--|-------------------------|-----|
| | KIKAS Aleksei | EST |
| | SATOROVIC Emir | AUT |
| | WIESENBERGER Till Louis | GER |
| | HASANLI Aykhan | AZE |
| | VAN WOENSEL Ties | NED |
| | MADSEN Emil | DEN |
| | ADAMEC Maxmilian Tomas | CZE |
| | ROSENBERG Yoav | ISR |
| | NURTILEKOV Elgazy | KGZ |
| | BECK Flynt | GER |
| | PETRE David | ROU |
| | POPIVODA Vukan | MNE |
| | NUX Alexandre | FRA |
| | NURM August Martin | EST |
| | OSMANI Mensur | GER |

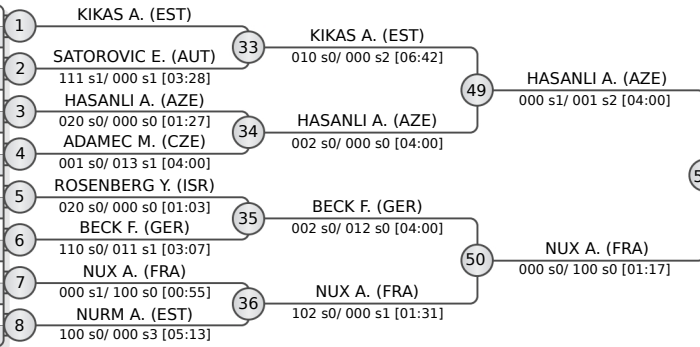

POOL B

| | | |
|--|-------------------|-----|
| | TOOMEL Joosep | EST |
| | MATTSSON Kalle | SWE |
| | KILADZE Giga | GER |
| | SILLAH Moise | GER |
| | KRMEK Roko Ivan | CRO |
| | PUGH Harvey | GBR |
| | SUPAKHUNOV David | LTU |
| | MAMMADOV Yagub | AZE |
| | KATSARSKI Teodor | BUL |
| | SCHWENKE Johann | GER |
| | GKOLIAS Efthymios | GRE |
| | HARCAVI Adam | ISR |
| | FENSKI Ole | GER |
| | SILLAR Richard | EST |

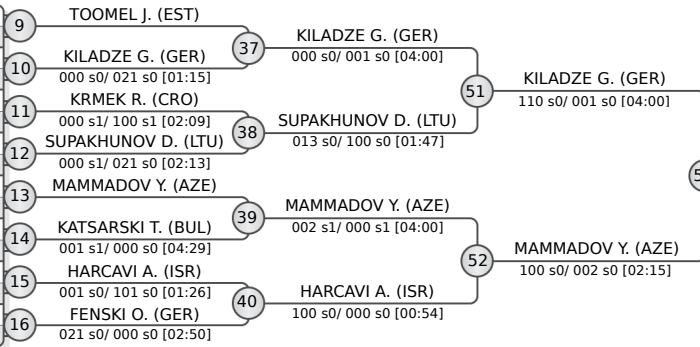

POOL C

| | | |
|--|----------------------|-----|
| | MEHDIYEV Amin | AZE |
| | MOOR Louis-Alexander | GER |
| | ERIKSON Mattias | EST |
| | ERLICH Roland | GER |
| | ISAKOV Baiel | KGZ |
| | IURCOVSCHI Daniel | FRA |
| | NAGY Akos | ROU |
| | HASANLI Polad | AZE |
| | AHRENS Jan Alexander | GER |
| | PODKUJKO Igors | LAT |
| | FARFELEDER Samuel | AUT |
| | KOHVER Siim | EST |
| | DAVIDASHVILY Yakov | ISR |
| | FACHIRIDIS Stavros | GER |
| | SILVA Vicente | POR |

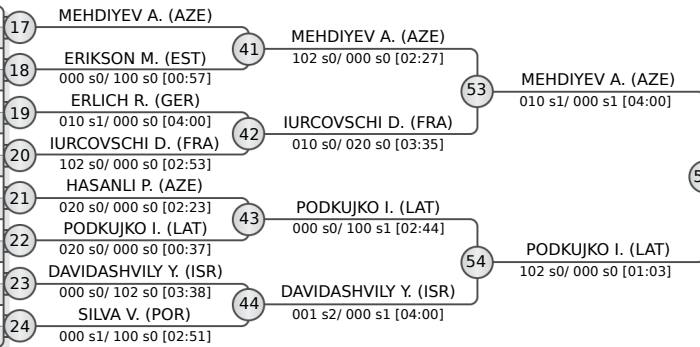

POOL D

| | | |
|--|--------------------|-----|
| | VALA Lukas | CZE |
| | VAN DER KROON Jan | NED |
| | UNTERBERG Lev | GER |
| | PONOMARENKO Ivan | GER |
| | MCGIVERN Aodhan | GBR |
| | MATHUES Sid | BEL |
| | CANEPARI Riccardo | ITA |
| | SUNNATOV Samandar | UZB |
| | SEIDELBERG Marten | EST |
| | DIMITROV Plamen | BUL |
| | MINICH Michail | GER |
| | KRZELJ Dante | CRO |
| | BEN SHITRIT Ehud | ISR |
| | KUNSZABO Matei | ROU |
| | KARAZELIDIS Pavlos | GER |

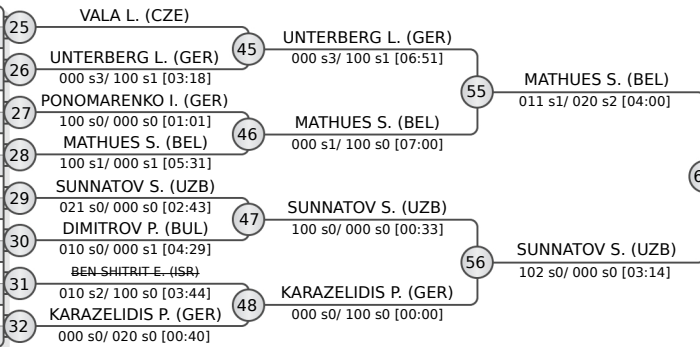

| FINAL RESULTS | | |
|---------------|-------------------|-----|
| 1. | SUNNATOV Samandar | UZB |
| 2. | HASANLI Aykhan | AZE |
| 3. | MEHDIYEV Amin | AZE |
| 3. | MAMMADOV Yagub | AZE |
| 5. | KILADZE Giga | GER |
| 5. | MATHUES Sid | BEL |
| 7. | KIKAS Aleksei | EST |
| 7. | PODKUJKO Igors | LAT |

REPECHAGE

| | |
|--|----------------------|
| | VAN WOENSEL T. (NED) |
| | ADAMEC M. (CZE) |
| | KATSARSKI T. (BUL) |
| | ERIKSON M. (EST) |
| | SEIDELBERG M. (EST) |
| | DIMITROV P. (BUL) |

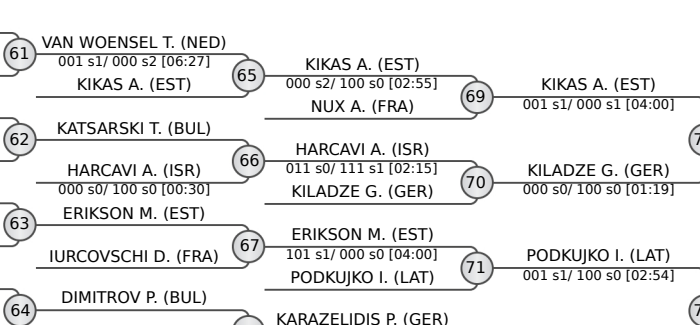



Berlin Millennium Team Cadet European Cup 2026

Germany, Berlin, 25-26 Apr 2026

-90 kg

Cadets (34)

POOL A

| | | | |
|---|-------------------------------|---|---------------------|
| 1 | BABAICENKO Tajus (LTU) | 1 | BABAICENKO T. (LTU) |
| 2 | CLEDJO Mathys (BEL) | 2 | CLEDJO M. (BEL) |
| 3 | BEYELER Gabriel (SUI) | 3 | BEYELER G. (SUI) |
| 4 | KHABIR Mehdi (FRA) | 4 | KHABIR M. (FRA) |
| 5 | YRYSOLOTOV Mukhammedali (KGZ) | 5 | YRYSOLOTOV M. (KGZ) |
| 6 | NAUTA Jacob (NED) | 6 | NAUTA J. (NED) |
| 7 | GRAEBER Julian (GER) | 7 | GRAEBER J. (GER) |
| 8 | SEBELKA Hugo (CZE) | 8 | SEBELKA H. (CZE) |

POOL B

| | | | |
|----|-----------------------------|----|------------------------|
| 9 | MARKOVIC Arian (CRO) | 9 | MARKOVIC A. (CRO) |
| 10 | TRUUVERK Huud-Keerit (EST) | 10 | TRUUVERK H. (EST) |
| 11 | NIELSEN Holger (DEN) | 11 | SHNIDER O. (ISR) |
| 12 | SHNIDER Omer (ISR) | 12 | SHNIDER O. (ISR) |
| 13 | WOERMANSEDER Johannes (AUT) | 13 | WOERMANSEDER J. (AUT) |
| 14 | KOLOSOVS Dmitrijs (LAT) | 14 | KOLOSOVS D. (LAT) |
| 15 | SEGUIN RENDAL Ian (ESP) | 15 | SEGUIN RENDAL I. (ESP) |
| 16 | ALIYEV Nuraddin (AZE) | 16 | ALIYEV N. (AZE) |
| 17 | AL-HASSANI Saged (GER) | 17 | AL-HASSANI S. (GER) |

POOL C

| | | | |
|----|---------------------------|----|----------------------|
| 18 | ESHPUKATOV Jurabek (UZB) | 18 | ESHPUKATOV J. (UZB) |
| 19 | LEETSAR Kaur (EST) | 19 | LEETSAR K. (EST) |
| 20 | KONOPLYANYK Nikolai (BEL) | 20 | KONOPLYANYK N. (BEL) |
| 21 | EMILOV Bobi (BUL) | 21 | EMILOV B. (BUL) |
| 22 | SIGNORINI Nicolo (ITA) | 22 | SIGNORINI N. (ITA) |
| 23 | VRABETZ Alexander (AUT) | 23 | BOOMKAMP M. (NED) |
| 24 | BOOMKAMP Marinus (NED) | 24 | BOOMKAMP M. (NED) |
| 25 | ALBRECHT Anton (GER) | 25 | ALBRECHT A. (GER) |
| 26 | SIDLAUSKAS Jokubas (LTU) | 26 | SIDLAUSKAS J. (LTU) |

POOL D

| | | | |
|----|------------------------------|----|---------------------------|
| 27 | SCHEIBER Felix (AUT) | 27 | SCHEIBER F. (AUT) |
| 28 | AKHUNDOV Omar (AZE) | 28 | AKHUNDOV O. (AZE) |
| 29 | KISSK Julian Henryk (GER) | 29 | KISSK J. (GER) |
| 30 | AMACIN Marlone (FRA) | 30 | AMACIN M. (FRA) |
| 31 | GOLTZ Jerome (GER) | 31 | GOLTZ J. (GER) |
| 32 | FERNANDEZ CALERO Pablo (ESP) | 32 | FERNANDEZ CALERO P. (ESP) |
| 33 | GARAGAU Razvan (ROU) | 33 | GARAGAU R. (ROU) |
| 34 | LAJCAK Ondrej (CZE) | 34 | LAJCAK O. (CZE) |

REPECHAGE

| | | | |
|----|------------------------|----|------------------------|
| 35 | CLEDJO M. (BEL) | 35 | CLEDJO M. (BEL) |
| 36 | KHABIR M. (FRA) | 36 | KHABIR M. (FRA) |
| 37 | SEGUIN RENDAL I. (ESP) | 37 | SEGUIN RENDAL I. (ESP) |
| 38 | ALIYEV N. (AZE) | 38 | ALIYEV N. (AZE) |
| 39 | LEETSAR K. (EST) | 39 | LEETSAR K. (EST) |
| 40 | KONOPLYANYK N. (BEL) | 40 | KONOPLYANYK N. (BEL) |
| 41 | SCHEIBER F. (AUT) | 41 | SCHEIBER F. (AUT) |
| 42 | KISSK J. (GER) | 42 | KISSK J. (GER) |
| 43 | LAJCAK O. (CZE) | 43 | LAJCAK O. (CZE) |

| FINAL RESULTS | | |
|---------------|-------------------------|-----|
| 1. | BABAICENKO Tajus | LTU |
| 2. | AKHUNDOV Omar | AZE |
| 3. | YRYSOLOTOV Mukhammedali | KGZ |
| 3. | SCHEIBER Felix | AUT |
| 5. | ESHPUKATOV Jurabek | UZB |
| 5. | KOLOSOVS Dmitrijs | LAT |
| 7. | ALIYEV Nuraddin | AZE |
| 7. | BOOMKAMP Marinus | NED |





Berlin Millennium Team Cadet European Cup 2026

Germany, Berlin, 25-26 Apr 2026

+ 90 kg

Cadets (20)

POOL A

| | | |
|--|-------------------|-----|
| | SKODA Melichar | CZE |
| | KIASUMBUA Eilijah | FRA |
| | IKMAN Den | ISR |
| | TEGELAAR Jack | SWE |
| | THAMM Max Anton | GER |

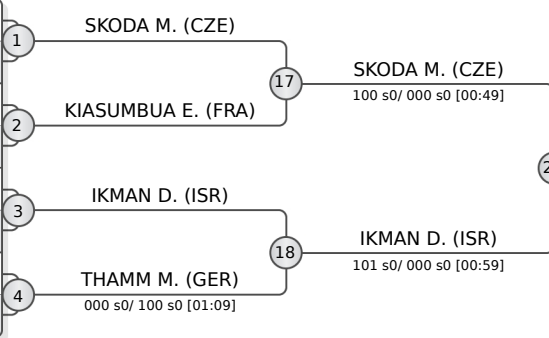

POOL B

| | | |
|--|--------------------|-----|
| | TOLIBAEV Ersultan | UZB |
| | SOM Samuel | FRA |
| | LOBATO PEREZ Aimar | ESP |
| | BADEA Petru | ROU |
| | BRUINING Joshua | NED |

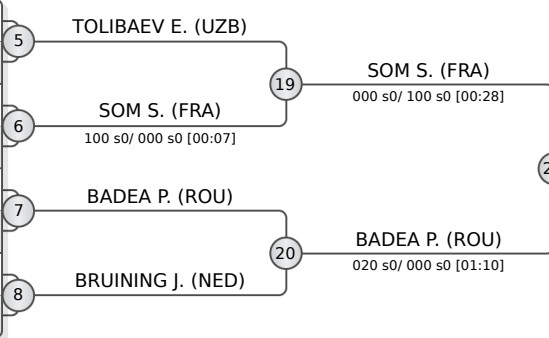

POOL C

| | | |
|--|---------------------|-----|
| | APSALONS Aleksandrs | LAT |
| | LODDES Romet | EST |
| | BRUNNER Jan | CZE |
| | RIETDIJK Keano | NED |
| | STETTINSKY Lucas | GER |

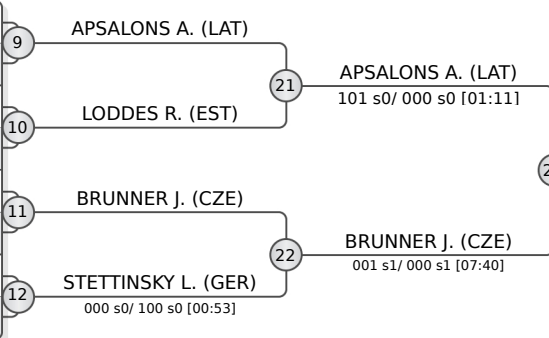

POOL D

| | | |
|--|----------------------|-----|
| | ALIYEV Tamerlan | AZE |
| | SAURA Nathan | FRA |
| | BRAUSEWETTER Maarten | GER |
| | KAZIMOV Ruslan | AZE |
| | BOLOTBEKOV Altynbek | KGZ |

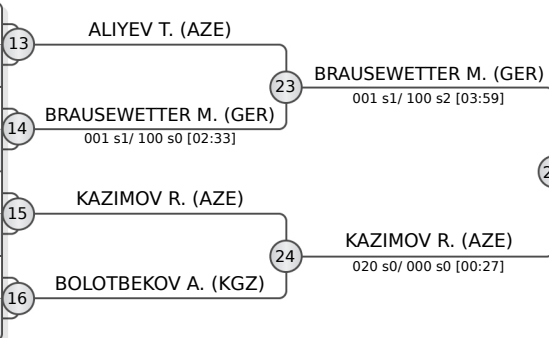

REPECHAGE

| | |
|----|---------------------|
| 29 | KIASUMBUA E. (FRA) |
| 30 | BRUINING J. (NED) |
| 31 | LODDES R. (EST) |
| 32 | BOLOTBEKOV A. (KGZ) |

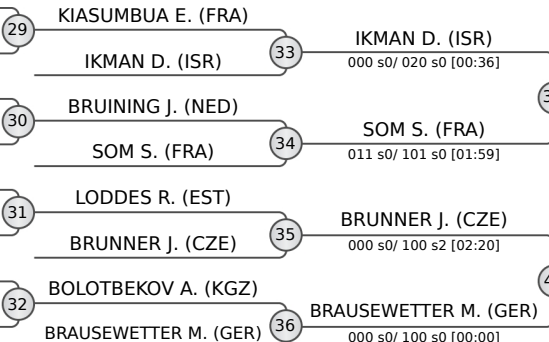

| FINAL RESULTS | | |
|---------------|----------------------|-----|
| 1. | SKODA Melichar | CZE |
| 2. | APSALONS Aleksandrs | LAT |
| 3. | KAZIMOV Ruslan | AZE |
| 3. | BADEA Petru | ROU |
| 5. | SOM Samuel | FRA |
| 7. | BRUNNER Jan | CZE |
| 7. | IKMAN Den | ISR |
| 7. | BRAUSEWETTER Maarten | GER |





Berlin Millennium Team Cadet European Cup 2026

Germany, Berlin, 25-26 Apr 2026

-40 kg

Cadets (16)

POOL A

| | | |
|--|-------------------|-----|
| | GRACOVA Dominika | CZE |
| | BARRAY Jade | FRA |
| | BREM Nawaii | NED |
| | CRACIUN Ana Maria | ROU |

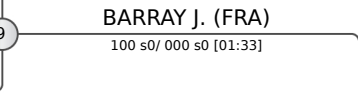
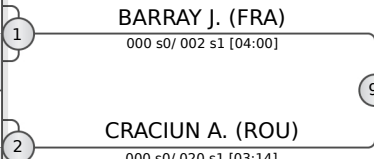

POOL B

| | | |
|--|---------------------|-----|
| | KARAKAZAN Elcin | TUR |
| | EMMERLING Greta | GER |
| | SIROJIDDINOVA Iroda | UZB |
| | GULIYEVA Zahra | AZE |

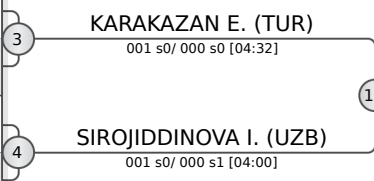

POOL C

| | | |
|--|-------------------|-----|
| | TOKMAK Havva Sena | TUR |
| | MOUSSATI Assia | FRA |
| | SALAMOVA Sunay | AZE |
| | PHAM Serra | NED |

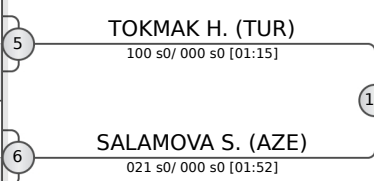

POOL D

| | | |
|--|----------------------|-----|
| | GAT MUALEM Avigayil | ISR |
| | BALANEAN Stefania | ROU |
| | COSTA CABANA Candela | ESP |
| | SCHEIDA Julia | GER |

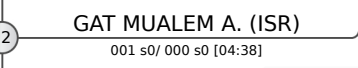
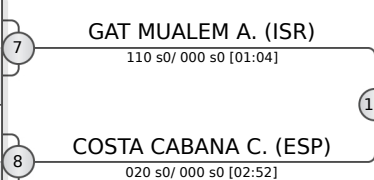

REPECHAGE

| | | |
|--------------------|----|--|
| GRACOVA D. (CZE) | 13 | GRACOVA D. (CZE) 100 s0/ 000 s0 [00:58] |
| EMMERLING G. (GER) | 14 | SIROJIDDINOVA I. (UZB) 001 s0/ 020 s0 [01:15] |
| PHAM S. (NED) | 15 | TOKMAK H. (TUR) 001 s0/ 020 s0 [01:15] |
| BALANEAN S. (ROU) | 16 | COSTA CABANA C. (ESP) 001 s0/ 020 s0 [01:15] |

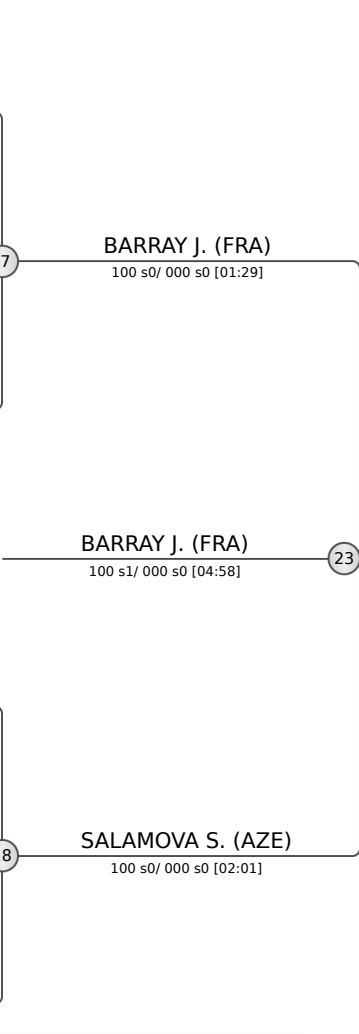
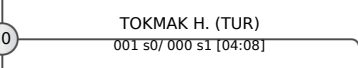
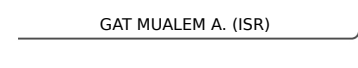
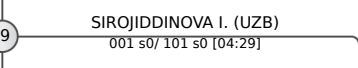
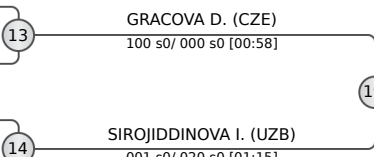

| FINAL RESULTS | | |
|---------------|----------------------|-----|
| 1. | BARRAY Jade | FRA |
| 2. | SALAMOVA Sunay | AZE |
| 3. | SIROJIDDINOVA Iroda | UZB |
| 3. | TOKMAK Havva Sena | TUR |
| 5. | GAT MUALEM Avigayil | ISR |
| 5. | KARAKAZAN Elcin | TUR |
| 7. | GRACOVA Dominika | CZE |
| 7. | COSTA CABANA Candela | ESP |





Berlin Millennium Team Cadet European Cup 2026

Germany, Berlin, 25-26 Apr 2026

-44 kg

Cadets (31)

POOL A

| | | |
|--|--------------------|-----|
| | LONGO Sofia | ITA |
| | MICHI Vivian Marie | GER |
| | HEYDARZADE Nigar | AZE |
| | DAVIS Katrina | GBR |
| | BROUNEN Fem | NED |
| | BIRINCI Hiranur | TUR |
| | SOFFER Lihi | ISR |

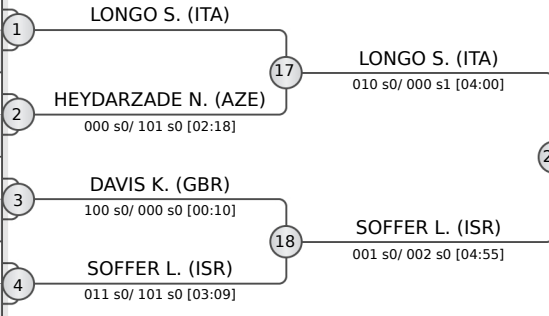

POOL B

| | | |
|--|----------------------|-----|
| | CONI Sara | ITA |
| | LUDVIG Amalia | ROU |
| | SOUBIELLE Maia | FRA |
| | SAMARDZHIDI Anna | AUT |
| | PEETERS Fenne | BEL |
| | KOLUCHEVA Alina | UZB |
| | MONZO PASCUAL Marta | ESP |
| | STEPANOVA Anastasiia | KGZ |

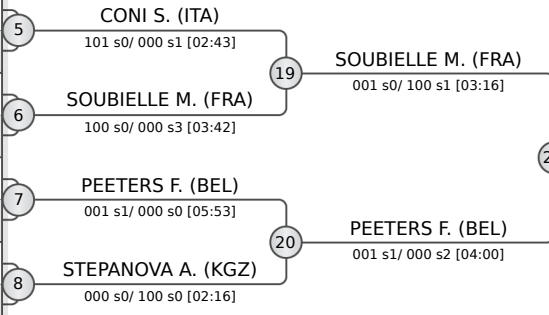

POOL C

| | | |
|--|--------------------|-----|
| | YILMAZTURK Yagmur | TUR |
| | ITSKOV Rivka | ISR |
| | HISSETTE Nell | BEL |
| | KILACKOVA Silvia | SVK |
| | ABDULLAYEVA Fatima | AZE |
| | MARIAN Daria | ROU |
| | BOLTABOEVA Dilafuz | UZB |
| | GRAVENSTIJN Tracey | NED |

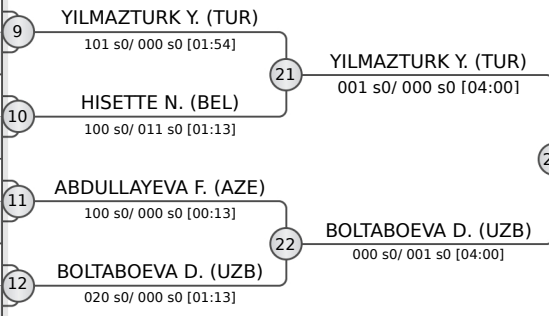

POOL D

| | | |
|--|------------------------|-----|
| | MANASBEKOVA Munira | KGZ |
| | VALVERDE DURAN Claudia | ESP |
| | SEVKHANLI Parvin | AZE |
| | SAMARDZHIDI Maria | AUT |
| | CIUMAS Bianca | ROU |
| | DEEB Leia | GER |
| | SURDEZ KAUL Zelig | FRA |
| | OSTERBERG Josephine | SWE |

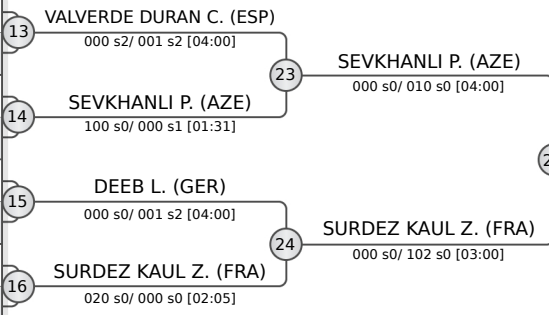

REPECHAGE

| | | |
|-------------------------|----|-------------------------|
| HEYDARZADE N. (AZE) | 29 | HEYDARZADE N. (AZE) |
| SAMARDZHIDI A. (AUT) | 30 | CONI S. (ITA) |
| CONI S. (ITA) | 30 | CONI S. (ITA) |
| ITSKOV R. (ISR) | 31 | HISSETTE N. (BEL) |
| HISSETTE N. (BEL) | 31 | HISSETTE N. (BEL) |
| SAMARDZHIDI M. (AUT) | 32 | VALVERDE DURAN C. (ESP) |
| VALVERDE DURAN C. (ESP) | 32 | VALVERDE DURAN C. (ESP) |

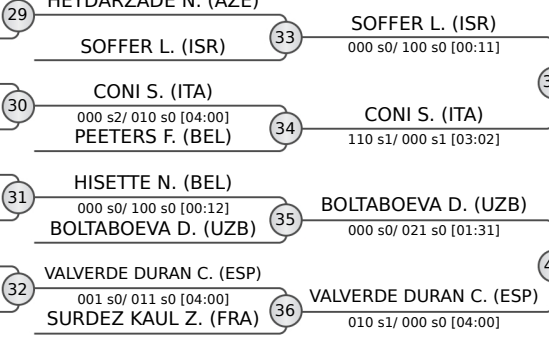

YILMAZTURK Y. (TUR) 43
000 s2/ 010 s1 [04:38]

YILMAZTURK Y. (TUR) 38
020 s0/ 000 s1 [02:11]

| FINAL RESULTS | |
|---------------|----------------------------|
| 1. | YILMAZTURK Yagmur TUR |
| 2. | LONGO Sofia ITA |
| 3. | SEVKHANLI Parvin AZE |
| 3. | BOLTABOEVA Dilafuz UZB |
| 5. | CONI Sara ITA |
| 7. | SOUBIELLE Maia FRA |
| 7. | SOFFER Lihi ISR |
| 7. | VALVERDE DURAN Claudia ESP |





Berlin Millennium Team Cadet European Cup 2026

Germany, Berlin, 25-26 Apr 2026

-48 kg

Cadets (37)

POOL A

| | | |
|-----|---------------------|---|
| ISR | NOY Agam Sol | 1 |
| NED | NIJHUIS Jelena | 2 |
| AZE | ZEYNALOVA Sakina | 3 |
| GBR | DOE Betsy | 4 |
| POR | CARVALHO Mariana | 5 |
| TUR | COSKUN Busra Ceylin | 6 |
| AUT | KUNYIK Laura-Sophie | 7 |
| BEL | MARTINEZ Navia | 8 |
| GER | BRUNETT Hanna | 9 |

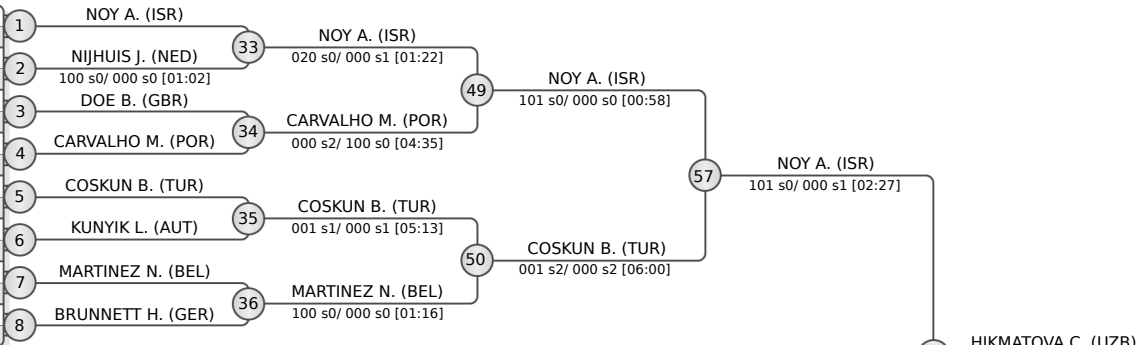

POOL B

| | | |
|-----|----------------------------|----|
| UZB | HIKMATOVA Charos | 10 |
| GER | KRATZER Helene | 11 |
| FRA | STEFANIE Mamitantly Oceana | 12 |
| ROU | ROGOJINARU Adelina | 13 |
| ISR | BIRGER Ella | 14 |
| ITA | STORIONE Ludovica | 15 |
| POR | SOARES Maria | 16 |
| ESP | SANTIN MORENO Miriam | 17 |
| SWE | WIJK Alma | 18 |
| SRB | GORANOVIC Katarina | 19 |

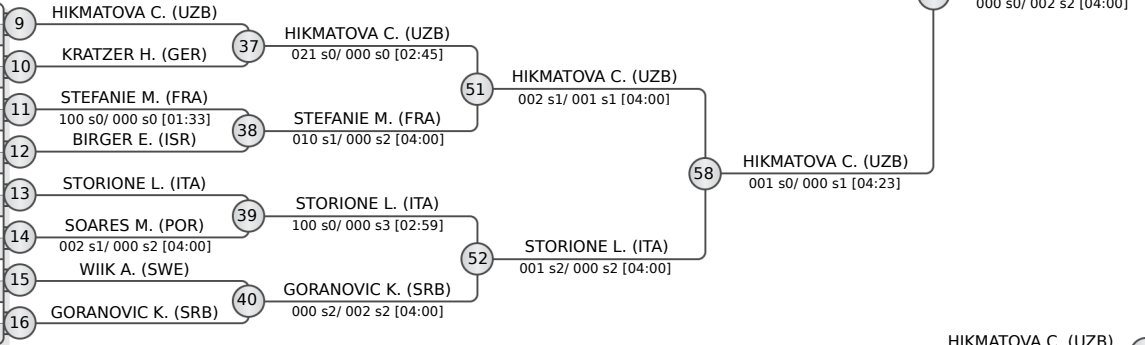

POOL C

| | | |
|-----|-----------------------|----|
| ISR | STARK Leeyam | 20 |
| GER | KOEPPEN Jane | 21 |
| SWE | WAHLSTROM Selma | 22 |
| BEL | GRIGORYAN Viktoria | 23 |
| GER | BEERMANN Mia Marie | 24 |
| DEN | FONSBOEL Elena | 25 |
| ESP | REMIGIO RUIZ Nadia | 26 |
| GBR | BUCHANAN Alexis | 27 |
| LTU | VALKAUSKAITE Vismante | 28 |

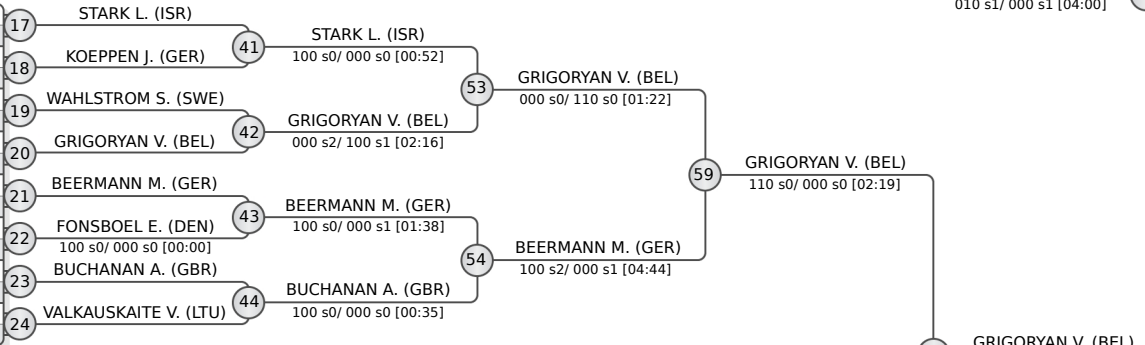

POOL D

| | | |
|-----|-----------------------|----|
| AZE | EYVAZLI Konul | 29 |
| AUT | MANTAEVA Jasmina | 30 |
| ESP | BELTRAN MARUENDA Ivet | 31 |
| FRA | TIXIER Line | 32 |
| POR | FRANCO Carolina | 33 |
| EST | AZARUMYAN Anna | 34 |
| SWE | FALDT Lova | 35 |
| GER | STEINBERG Michelle | 36 |
| CRO | KATUSIC Nika | 37 |

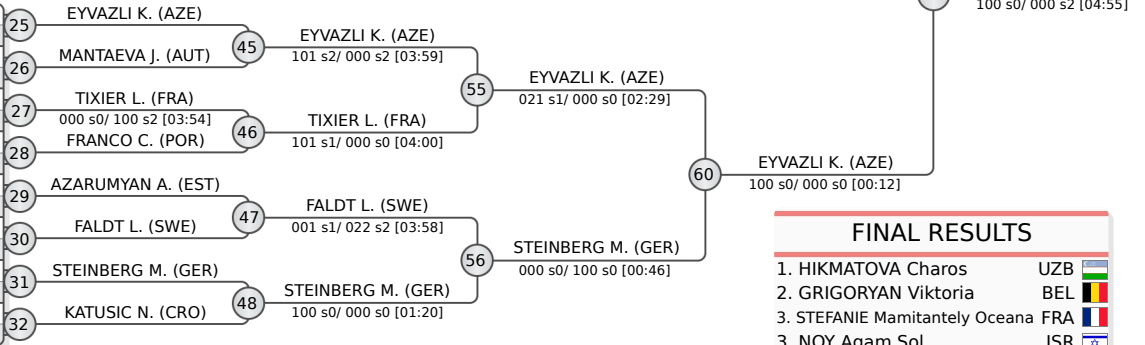

| | | |
|----|----------------------------|-----|
| 1. | HIKMATOVA Charos | UZB |
| 2. | GRIGORYAN Viktoria | BEL |
| 3. | STEFANIE Mamitantly Oceana | FRA |
| 3. | NOY Agam Sol | ISR |
| 5. | EYVAZLI Konul | AZE |
| 5. | BEERMANN Mia Marie | GER |
| 7. | NIJHUIS Jelena | NED |
| 7. | MANTAEVA Jasmina | AUT |

REPECHAGE

| | |
|----|--------------------|
| 61 | NIJHUIS J. (NED) |
| 62 | KRATZER H. (GER) |
| 63 | WAHLSTROM S. (SWE) |
| 64 | MANTAEVA J. (AUT) |

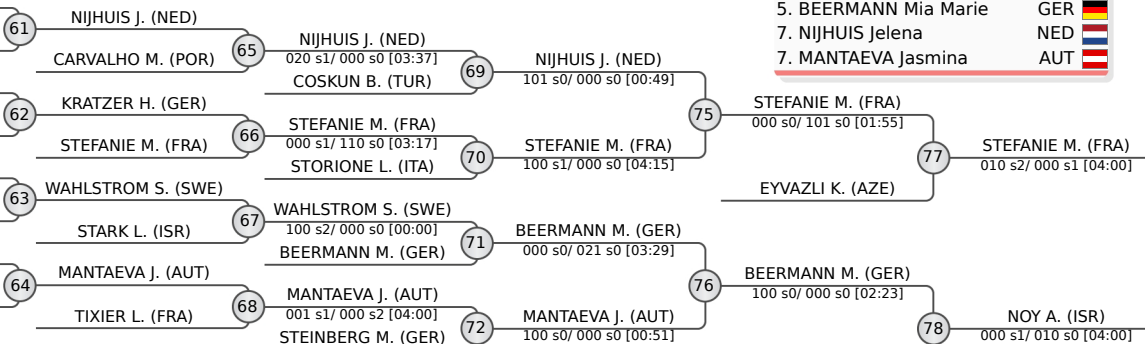



Berlin Millennium Team Cadet European Cup 2026

Germany, Berlin, 25-26 Apr 2026

-52 kg

Cadets (45)

POOL A

| | |
|-------------------------|-----|
| CHIRON Alexandra | MDA |
| KRZYZANIAK Zoe | GER |
| MARTIN TORRES Jimena | ESP |
| AKERSTROM Thelma | SWE |
| GUION Sofia | ITA |
| GOECKERITZ Leni | GER |
| SOUSA LAVANDEIRA Zeltia | ESP |
| WELLEKENS Amelie | BEL |
| KING Hannah | GBR |
| GUPALO Liana | GER |
| DOUMBIA Salma | FRA |

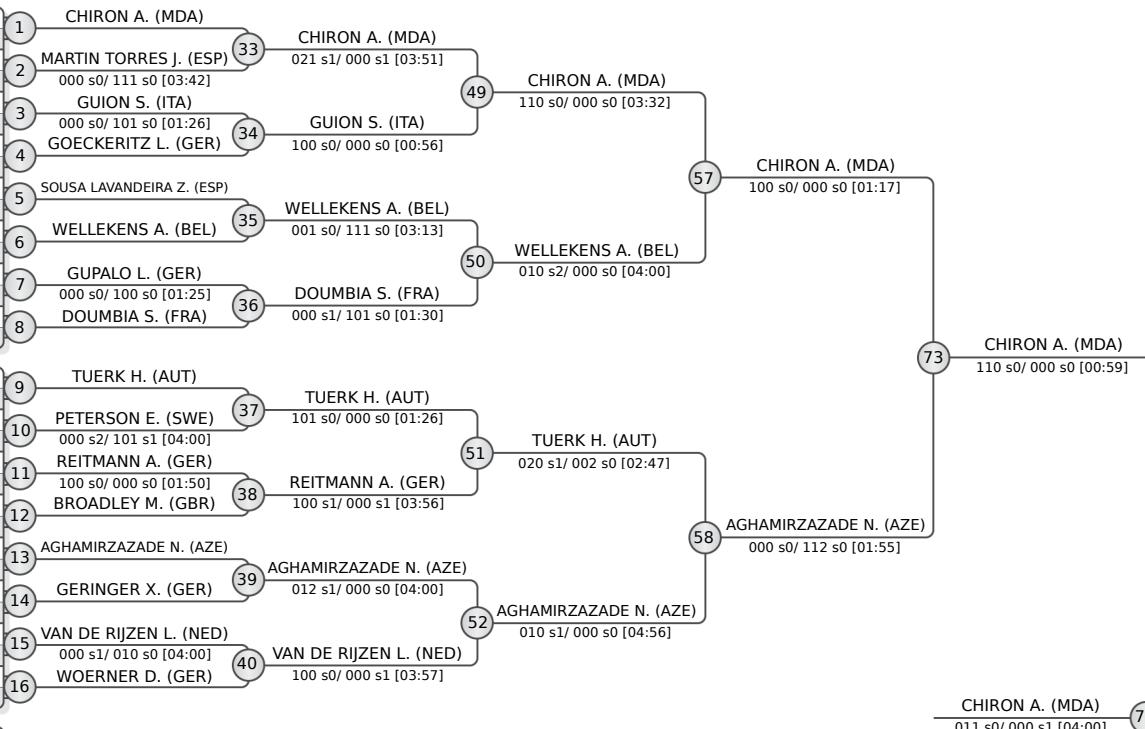

POOL B

| | |
|----------------------|-----|
| TUERK Helin | AUT |
| BUZINA Anastasia | EST |
| PETERSON Elsa | SWE |
| REITMANN Anna | GER |
| WOLSTER Gili Racheli | ISR |
| BROADLEY Maisie | GBR |
| AGHAMIRZAZADE Narmin | AZE |
| GERINGER Xenia | GER |
| TERES CEREZA Daniela | ESP |
| VAN DE RIJZEN Lieve | NED |
| WOERNER Daphne | GER |

POOL C

| | |
|-----------------------|-----|
| YAHAV Yali | ISR |
| BABAYEVA Tovsiyya | AZE |
| LAMM Valentina | AUT |
| MANTYKENTTA Sara | FIN |
| LARSEN Ria | SUI |
| KUKIC Lana | GER |
| BOSKUP Aysenur | TUR |
| TSIONARAS Dora Eleana | GER |
| HELGESSION Emilia | SWE |
| VAINER Xenia | MDA |
| LOPEZ GORDO Sofia | ESP |
| JAEGER Sophie | GER |

POOL D

| | |
|--------------------------|-----|
| VUKASOVIC Teodora | SRB |
| WEGELER Babette | GER |
| GRUBER Michelle | GER |
| CUSA Carla | ROU |
| PAUS Roni | ISR |
| FINDRIK Paula | CRO |
| DUBOSQ Ambre | FRA |
| ROMERA BARRAGAN Aniana | ESP |
| CEDERVALL CLAESSON Tilde | SWE |
| DALY Lucy | GBR |
| FOERSTER Mia | GER |

FINAL RESULTS

- CHIRON Alexandra MDA
- VUKASOVIC Teodora SRB
- BOSKUP Aysenur TUR
- AGHAMIRZAZADE Narmin AZE
- VAN DE RIJZEN Lieve NED
- YAHAV Yali ISR
- WELLEKENS Amelie BEL
- FINDRIK Paula CRO

REPECHAGE

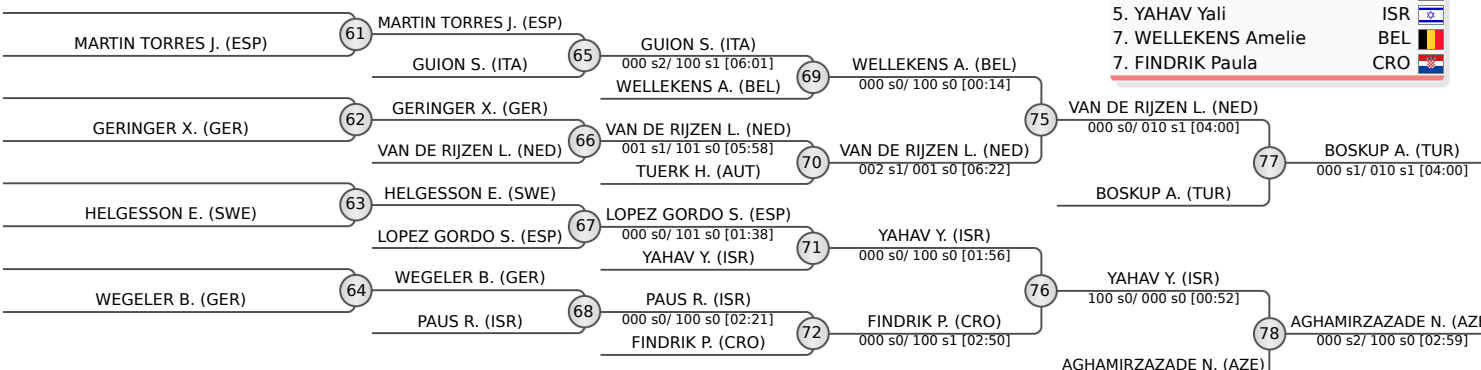



Berlin Millennium Team Cadet European Cup 2026

Germany, Berlin, 25-26 Apr 2026

-57 kg

Cadets (58)

POOL A

| | | | |
|---|----------------------------|----|------------------|
| 1 | KILIC Elif (TUR) | 33 | KILIC E. (TUR) |
| 2 | BOUVIL Clarisse (FRA) | 34 | YUSIFLI S. (AZE) |
| 3 | VAN BAAL Sjimie (NED) | 35 | BAECHLE S. (GER) |
| 4 | EVERS Josephine (GER) | 36 | ALIMOVA Z. (UZB) |
| 5 | NATARIO Maria (POR) | | |
| 6 | YUSIFLI Samaya (AZE) | | |
| 7 | VENDRELL JUAN Alexia (ESP) | | |
| 8 | SHATTOCK Maisie (GBR) | | |
| | BAECHLE Sophia (GER) | | |
| | JANSEN Marie-Lise (BEL) | | |
| | MELAMED Lee (ISR) | | |
| | ALIMOVA Zuhra (UZB) | | |
| | BLANK Emilia (GER) | | |
| | KILDEEVA Daria (FIN) | | |
| | BORUBOLOTOVA Milena (KGZ) | | |

POOL B

| | | | |
|----|-----------------------------|----|---------------------|
| 9 | CEPELAKOVA Lucie (CZE) | 37 | CEPELAKOVA L. (CZE) |
| 10 | PORCARI Miryam (ITA) | 38 | PETIDENT A. (FRA) |
| 11 | BACKLUND Nova (SWE) | 39 | PULJIC L. (CRO) |
| 12 | NEUMANN Raphael (ISR) | 40 | KRONENTHAL C. (GER) |
| 13 | STOEGMANN Isabella (AUT) | | |
| 14 | PETIDENT Ambre (FRA) | | |
| 15 | DRESSLER Lotta (GER) | | |
| 16 | PULJIC Lucija (CRO) | | |
| 17 | CHRISP Taylor (GBR) | | |
| 18 | BRAZINSKAITE Ieva (LTU) | | |
| 19 | ALONSO FERNANDEZ Sara (ESP) | | |
| 20 | RUSU Maria (MDA) | | |
| 21 | KRONENTHAL Charlotte (GER) | | |
| 22 | VALIZADA Sama (AZE) | | |

POOL C

| | | | |
|----|------------------------------|----|---------------------|
| 17 | KHAZRATOVA Gulsanam (UZB) | 41 | KHAZRATOVA G. (UZB) |
| 18 | TOPCU Ezgi (TUR) | 42 | OUWERKERK S. (NED) |
| 19 | HAYUN Romy (ISR) | 43 | MEKAITON S. (ISR) |
| 20 | SAS-ZALOZIECKI Valerie (AUT) | 44 | ACTIS M. (ITA) |
| 21 | OUWERKERK Shayen (NED) | | |
| 22 | DANISOVA Ema (SVK) | | |
| 23 | BRIAND Lea (GER) | | |
| 24 | MEKAITON Shira (ISR) | | |
| 25 | GUERRERO PADIN Ines (ESP) | | |
| 26 | MAMMADTAGHIYEVA Gulnaz (AZE) | | |
| 27 | BAUER Sina Josefin (GER) | | |
| 28 | ACTIS Margherita (ITA) | | |
| 29 | NEBHUTH Sophia (GER) | | |
| 30 | KERSYTE Airuna (LTU) | | |
| 31 | MITCHELL Evie (GBR) | | |

POOL D

| | | | |
|----|-----------------------------|----|-------------------|
| 25 | CHERNOVA Carina (POR) | 45 | CHERNOVA C. (POR) |
| 26 | MANECK Mia (GER) | 46 | ZINK M. (GER) |
| 27 | CAMERON Stella (GBR) | 47 | HASID D. (ISR) |
| 28 | ZINK Maxima (GER) | 48 | NARRAIN K. (GER) |
| 29 | LUOTO Ella (FIN) | | |
| 30 | ABU JAHRUR Ines (BEL) | | |
| 31 | BIXA Luzia (AUT) | | |
| 32 | HASID Daniella (ISR) | | |
| 33 | AHMADZADA Yagmur (AZE) | | |
| 34 | BELLEVAL Jaines (FRA) | | |
| 35 | STAIICU Patricia (ROU) | | |
| 36 | GRUEVA Dara (BUL) | | |
| 37 | NARRAIN Katharina (GER) | | |
| 38 | TASCON MARTIN Minerva (ESP) | | |

REPECHAGE

| | | | |
|----|---------------------------|----|---------------------|
| 61 | KILDEEVA D. (FIN) | 65 | KILDEEVA D. (FIN) |
| 62 | ALONSO FERNANDEZ S. (ESP) | 66 | PULJIC L. (CRO) |
| 63 | TOPCU E. (TUR) | 67 | OUWERKERK S. (NED) |
| 64 | GRUEVA D. (BUL) | 68 | HASID D. (ISR) |
| | | 69 | KILIC E. (TUR) |
| | | 70 | CEPELAKOVA L. (CZE) |
| | | 71 | OUWERKERK S. (NED) |
| | | 72 | CHERNOVA C. (POR) |

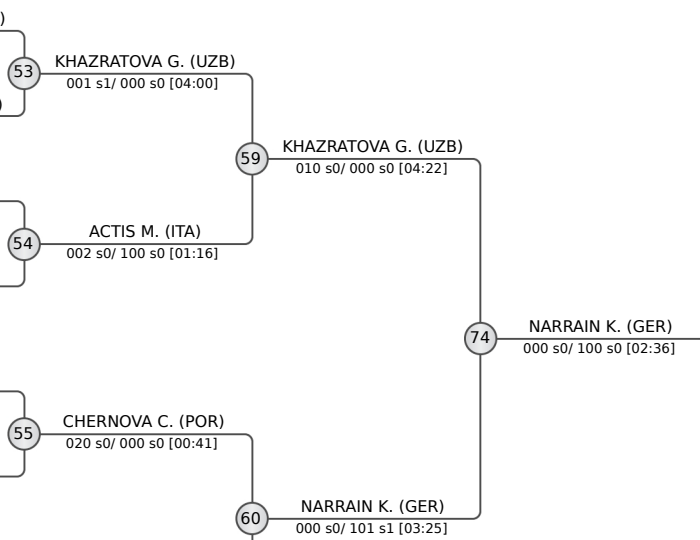
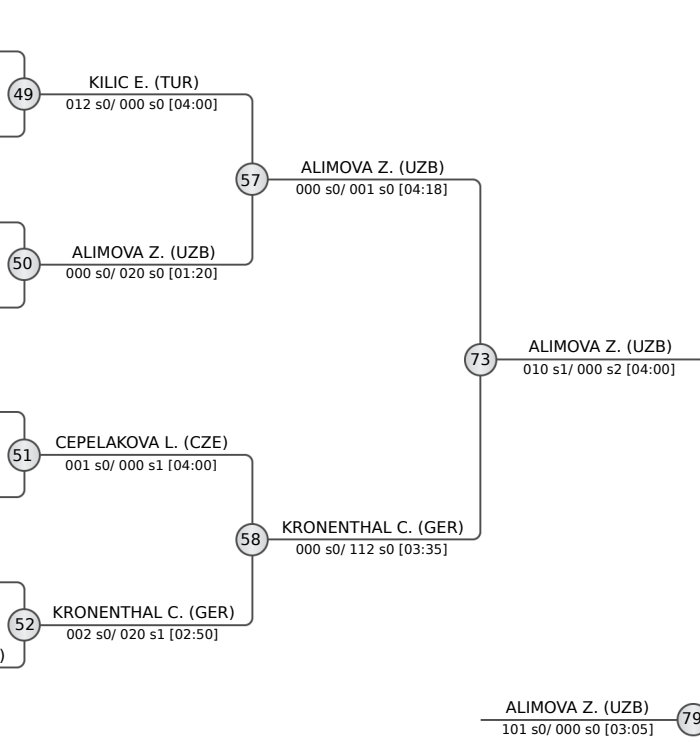

| FINAL RESULTS | | |
|---------------|----------------------|-----|
| 1. | ALIMOVA Zuhra | UZB |
| 2. | NARRAIN Katharina | GER |
| 3. | KILIC Elif | TUR |
| 3. | KRONENTHAL Charlotte | GER |
| 5. | KHAZRATOVA Gulsanam | UZB |
| 5. | CHERNOVA Carina | POR |
| 7. | CEPELAKOVA Lucie | CZE |
| 7. | OUWERKERK Shayen | NED |





Berlin Millennium Team Cadet European Cup 2026

Germany, Berlin, 25-26 Apr 2026

-63 kg

Cadets (48)

POOL A

| | | |
|--|---------------------------|-----|
| | BILEN Sevim Margaret | TUR |
| | KUTKEVICA Sofija | LAT |
| | SMITH Kayla | GBR |
| | VAN SON Frederique | NED |
| | LUEDTKE Lea Sophie | GER |
| | ROITBERG Emma | ITA |
| | VON LUTZ Sophia | AUT |
| | CALDEIRA Matilde | POR |
| | GONZALEZ ROMANILLOS Leyre | ESP |
| | CHIRILA Annalisa Nicole | ROU |
| | VALIYEVA Nazakat | AZE |
| | GRAFE Lene | GER |

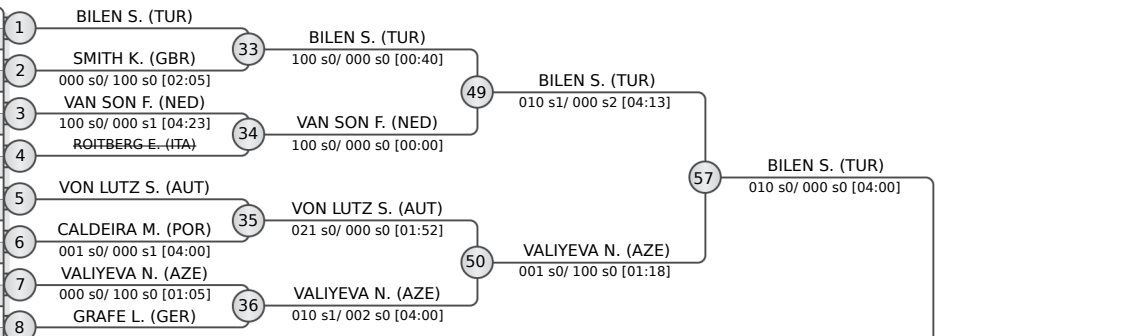

POOL B

| | | |
|--|-----------------------------|-----|
| | YILMAZ Duru | TUR |
| | BARONI Chiara | SUI |
| | GARCIA MONTES Judith Eloisa | ESP |
| | ROEMMER Amelie | GER |
| | LE TOUZE Lou | FRA |
| | KULIKAUSKAITE Meida | LTU |
| | STOEVA Andrea | BUL |
| | MUSAZZI Asia | ITA |
| | SHADI Gaida | AUT |
| | STOCK Luisa | GER |
| | KADYRKULOVA Medina | KGZ |
| | KROL Adel | ISR |

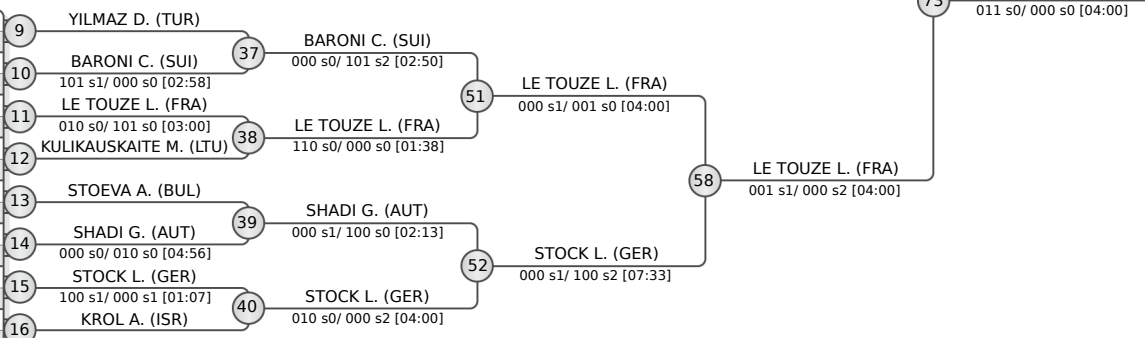

POOL C

| | | |
|--|--------------------------------|-----|
| | MASHURENKO Arina | UKR |
| | MATOUSKOVA Valentyna | CZE |
| | RODRIGUEZ SAENZ Ines | ESP |
| | BUETTNER Antonia | GER |
| | VASCO Ines | POR |
| | TREMBATCH Anna | FRA |
| | GLIGA Ana | ROU |
| | KAIN Kiara | AUT |
| | KOHLMANNLEHNER Nadja Alexandra | GER |
| | HUSEYNLI Zilan | AZE |
| | ZYGOMALA Ilektra | GRE |
| | BALYKIN Eden | ISR |

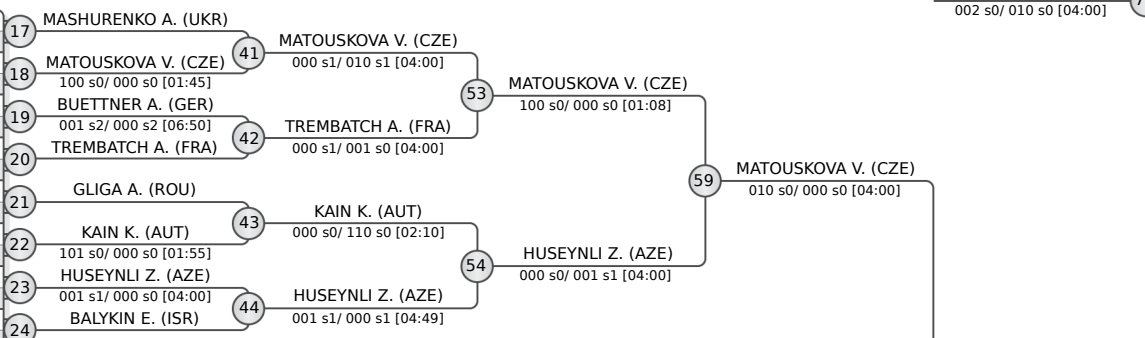

POOL D

| | | |
|--|-------------------------|-----|
| | RAMA Bleona | AUT |
| | BJORK DALBERG Lova | SWE |
| | ZAHHAROVA Anastasia | EST |
| | GUENTHER Salima | GER |
| | ZHARASHUEVA Hanifa | BEL |
| | CRISOSTOMO Joana Filipa | POR |
| | KYIALBEKOVA Aaisha | KGZ |
| | STRUJJK Jayda | NED |
| | MAMMADLI Turkan | AZE |
| | BESTAV Selin | TUR |
| | GIORDANO Valeria | ITA |
| | VOLK Latika | GER |

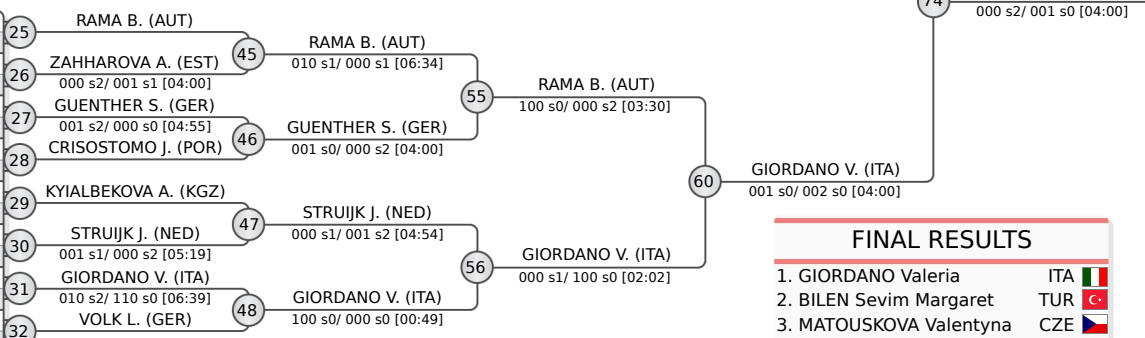

| FINAL RESULTS | | |
|---------------|----------------------|-----|
| 1. | GIORDANO Valeria | ITA |
| 2. | BILEN Sevim Margaret | TUR |
| 3. | MATOUSKOVA Valentyna | CZE |
| 3. | RAMA Bleona | AUT |
| 5. | VAN SON Frederique | NED |
| 7. | LE TOUZE Lou | FRA |
| 7. | STOCK Luisa | GER |
| 7. | HUSEYNLI Zilan | AZE |

REPECHAGE

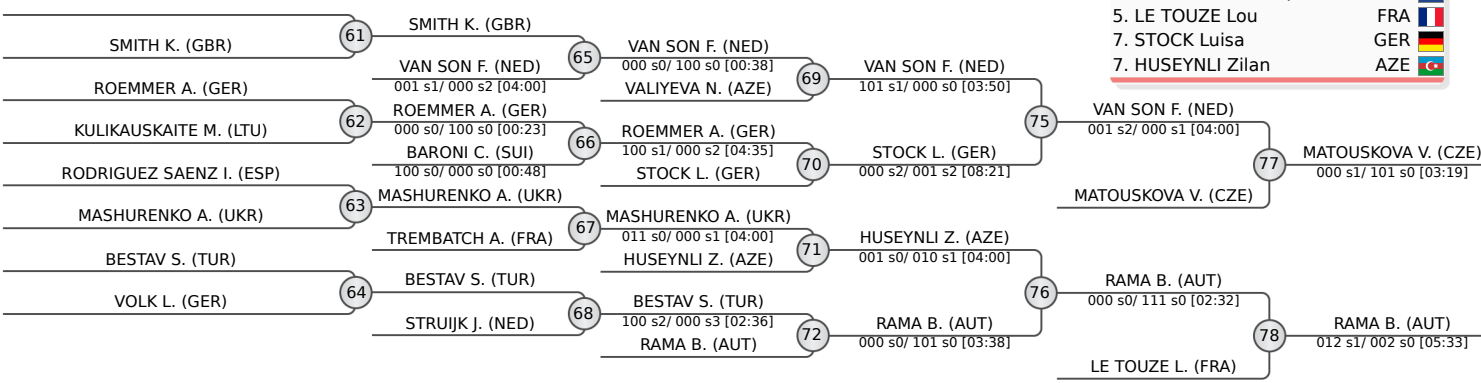



Berlin Millennium Team Cadet European Cup 2026

Germany, Berlin, 25-26 Apr 2026

-70 kg

Cadets (33)

POOL A

| | | |
|---|-----------------------------|-----|
| 1 | WOEGERER Selina | AUT |
| 2 | DAVIES Robyn | GBR |
| 3 | KARATAS Busra | TUR |
| 4 | PILZ Amelie Fabienne | GER |
| 5 | VENDRIG Esmee | NED |
| 6 | LEANZA Dorina | BEL |
| 7 | MALCZAK Lara Katharina | GER |
| 8 | MBENGUE RUANO Deguene Aisha | ESP |

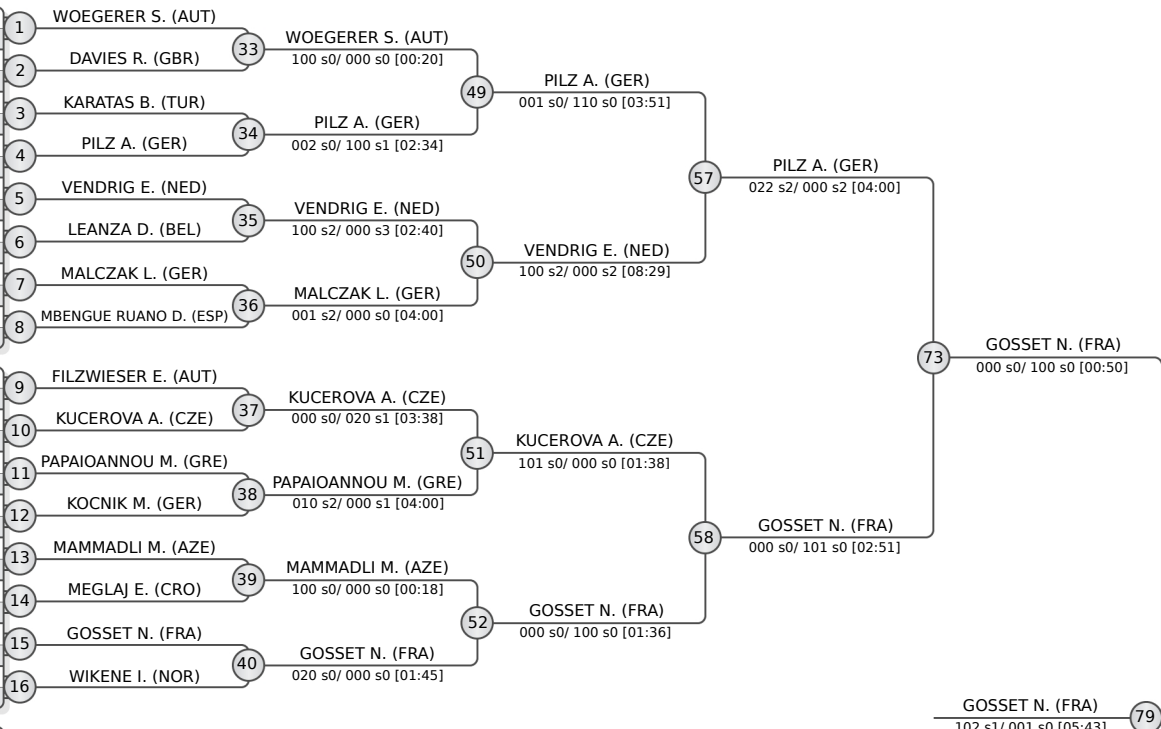

POOL B

| | | |
|----|--------------------------|-----|
| 9 | FILZWIESER Emma | AUT |
| 10 | KUCEROVA Anna | CZE |
| 11 | PAPAIANOANOU Maria Eleni | GRE |
| 12 | KOCNIK Mia Juno | GER |
| 13 | MAMMADLI Masuma | AZE |
| 14 | MEGLAJ Erika | CRO |
| 15 | GOSSET Norah | FRA |
| 16 | WIKENE Ingrid | NOR |

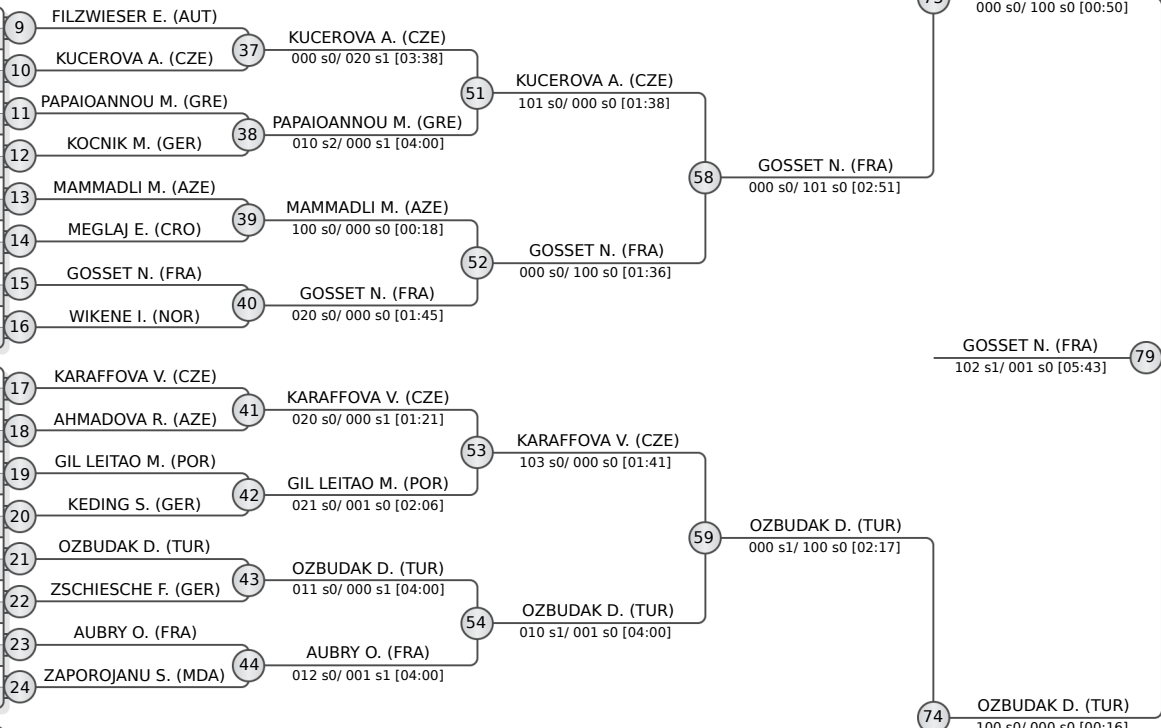

POOL C

| | | |
|----|-------------------------|-----|
| 17 | KARAFFOVA Vanessa | CZE |
| 18 | AHMADOVA Rena | AZE |
| 19 | GIL LEITAO Madalena | POR |
| 20 | KEDING Svenja | GER |
| 21 | OZBUDAK Done Melike | TUR |
| 22 | ZSCHIESCHE Frieda Hanni | GER |
| 23 | AUBRY Omairaa | FRA |
| 24 | ZAPOROJANU Sofia | MDA |

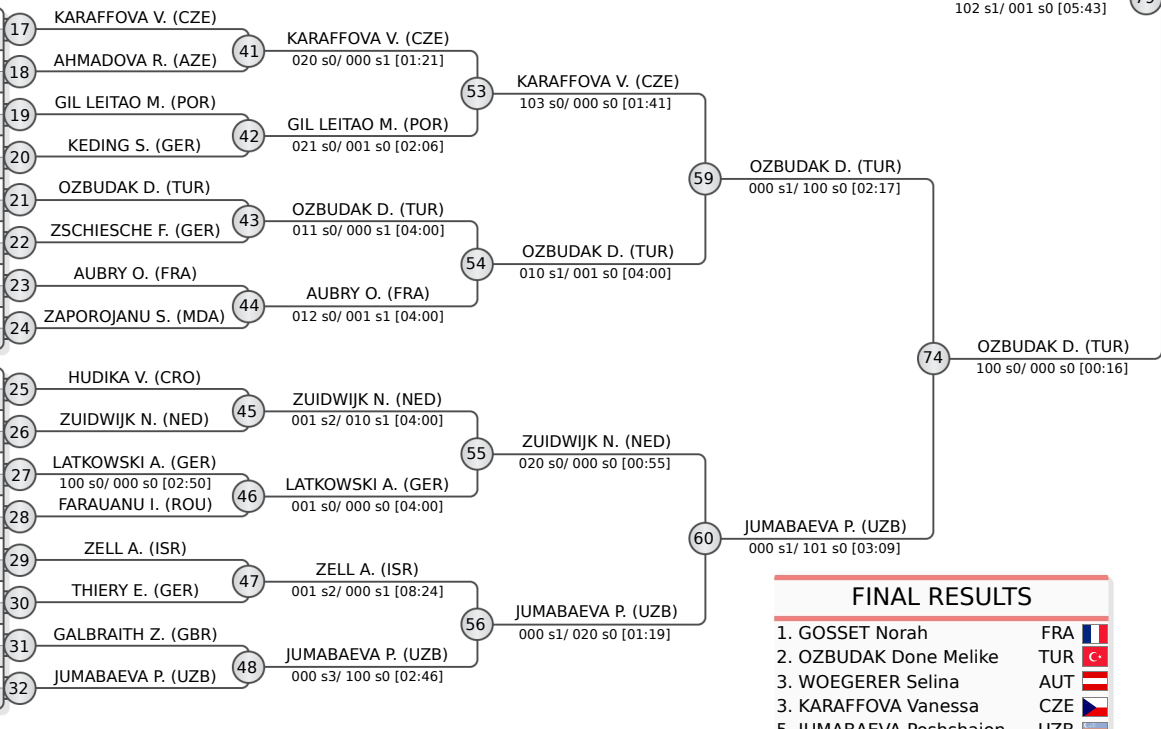

POOL D

| | | |
|----|----------------------|-----|
| 25 | HUDIKA Vita | CRO |
| 26 | ZUIDWIJK Noel | NED |
| 27 | LATKOWSKI Antonia | GER |
| 28 | RABL Nia | AUT |
| 29 | FARAUANU Iasmina | ROU |
| 30 | ZELL Amit | ISR |
| 31 | THIERY Emilie | GER |
| 32 | GALBRAITH Zoe | GBR |
| 33 | JUMABAEVA Poshshajon | UZB |

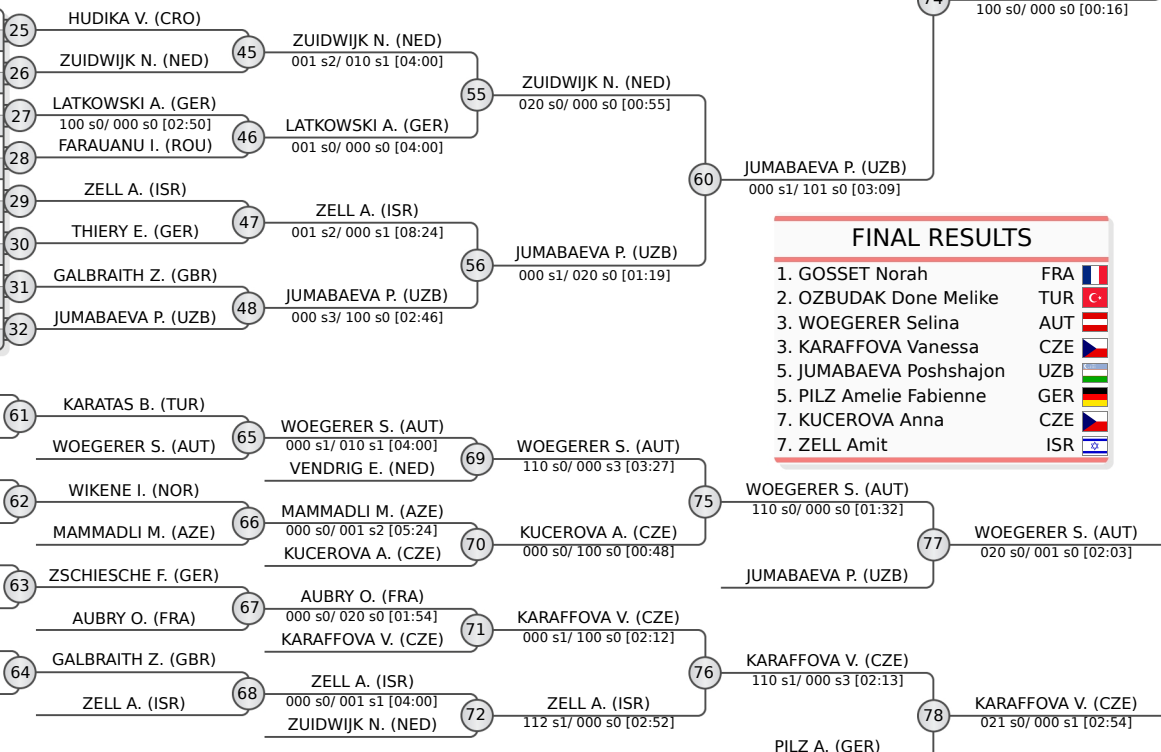

| FINAL RESULTS | | |
|---------------|----------------------|-----|
| 1. | GOSSET Norah | FRA |
| 2. | OZBUDAK Done Melike | TUR |
| 3. | WOEGERER Selina | AUT |
| 3. | KARAFFOVA Vanessa | CZE |
| 5. | JUMABAEVA Poshshajon | UZB |
| 5. | PILZ Amelie Fabienne | GER |
| 7. | KUCEROVA Anna | CZE |
| 7. | ZELL Amit | ISR |

REPECHAGE

| | |
|----|---------------------|
| 61 | KARATAS B. (TUR) |
| 62 | WIKENE I. (NOR) |
| 63 | ZSCHIESCHE F. (GER) |
| 64 | GALBRAITH Z. (GBR) |

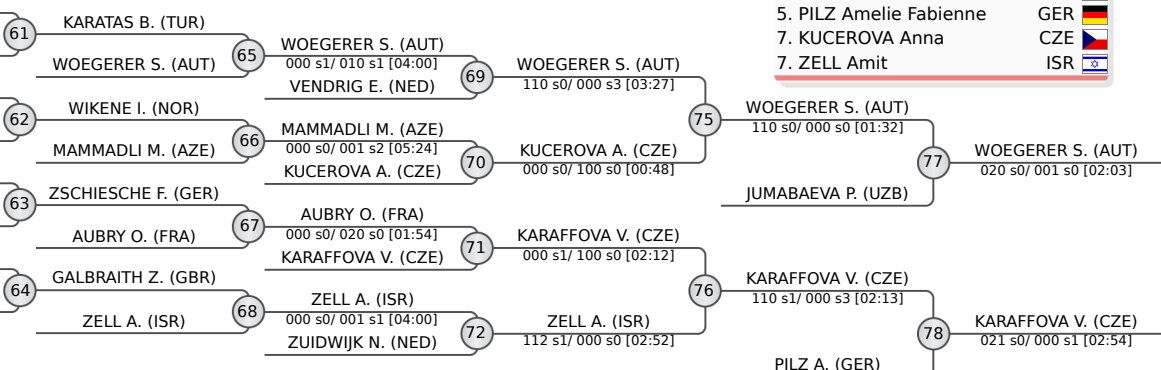



Berlin Millennium Team Cadet European Cup 2026

Germany, Berlin, 25-26 Apr 2026

+ 70 kg

Cadets (16)

POOL A

| | | |
|--|----------------------|-----|
| | BALCI Hatice Tuana | TUR |
| | WANDJI Maelyne | FRA |
| | VAN DRIEL Nova | NED |
| | BARNEKOW Lena Sophie | GER |

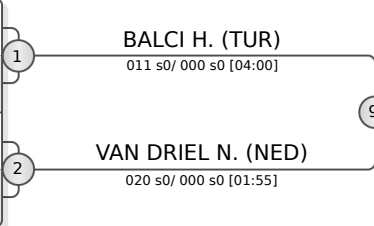

POOL B

| | | |
|--|-----------------------|-----|
| | PALERMO Elisa | ITA |
| | MOROU Hidaya | GER |
| | MAGASSA FOFANA Sogona | ESP |
| | VAN SUNDERT Fleur | NED |

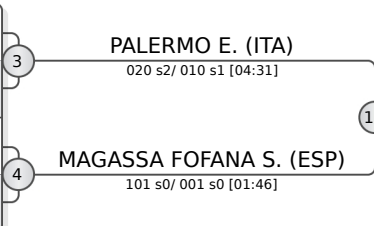

POOL C

| | | |
|--|------------------------------|-----|
| | COULIBALY TOURE Ballalo | ESP |
| | DECKER Meerit | GER |
| | SASSA-TATUKILA Therese-Grace | FRA |
| | HERMANS Tess | NED |

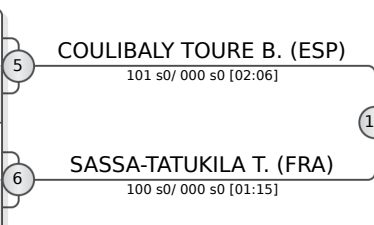

POOL D

| | | |
|--|---------------------|-----|
| | CHERKELIEVA Maria | BUL |
| | CONRAD Lucia | DEN |
| | ALIYEVA Zemfira | AZE |
| | BUSCHMANN Elisabeth | GER |

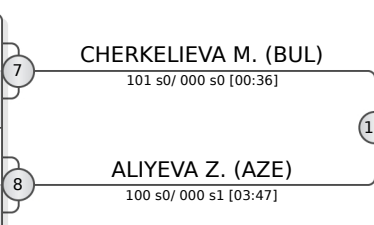

REPECHAGE

| | |
|--------------------------|----|
| WANDJI M. (FRA) | 13 |
| VAN DRIEL N. (NED) | 14 |
| VAN SUNDERT F. (NED) | 15 |
| PALERMO E. (ITA) | 16 |
| HERMANS T. (NED) | 17 |
| COULIBALY TOURE B. (ESP) | 18 |
| CONRAD L. (DEN) | 19 |
| ALIYEVA Z. (AZE) | 20 |

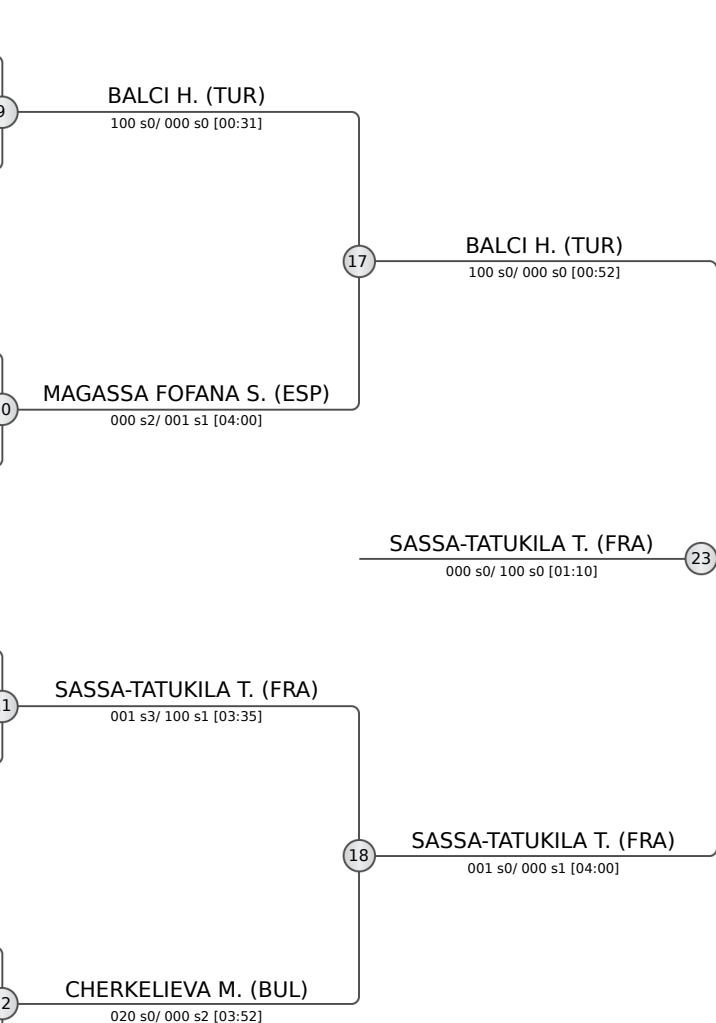
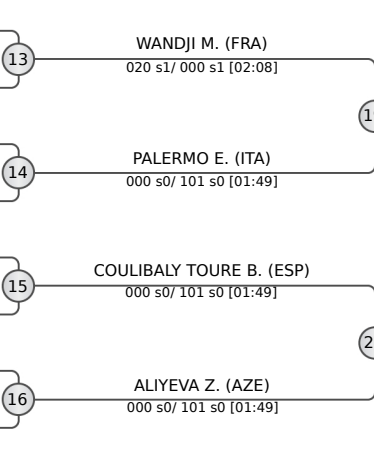

| FINAL RESULTS | | |
|---------------|------------------------------|-----|
| 1. | SASSA-TATUKILA Therese-Grace | FRA |
| 2. | BALCI Hatice Tuana | TUR |
| 3. | WANDJI Maelyne | FRA |
| 3. | COULIBALY TOURE Ballalo | ESP |
| 5. | CHERKELIEVA Maria | BUL |
| 5. | MAGASSA FOFANA Sogona | ESP |
| 7. | PALERMO Elisa | ITA |
| 7. | ALIYEVA Zemfira | AZE |

