



Kaunas Junior European Cup 2026

Lithuania, Kaunas, 25-26 Apr 2026

-66 kg

Juniors (36)

POOL A

	POLIKEVICIUS Simas	LTU	1
	SPINU Arsenijs	LAT	2
	ALSHAFI Ayoub	LBA	3
	JAKUBAUSKAS Adris	LTU	4
	JAKIMOV Robert	EST	5
	SANDLERMAN Artur	POL	6
	RABET Steven	GBR	7
	VAGULIS Danas	LTU	8
	BIELAN Aristarkh	UKR	8

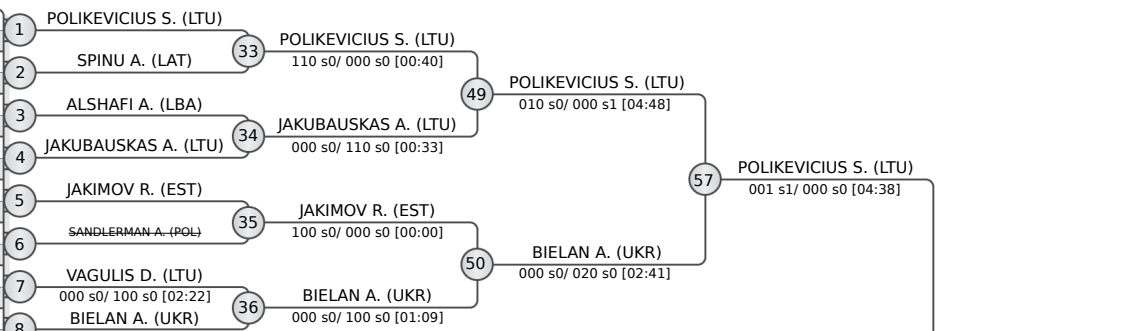

POOL B

	POBLOCKI Samir	SWE	9
	BASOV Renat	UKR	10
	BELIK Vadim	LTU	10
	BREKKE-JENSEN Torstein	NOR	11
	SRAPYAN Lyova	ARM	12
	MUNIZ ACOSTA Jakub	POL	13
	CONRAD Hector	DEN	14
	MAOR Ron	ISR	15
	SUZIEDELIS Aidas	LTU	16

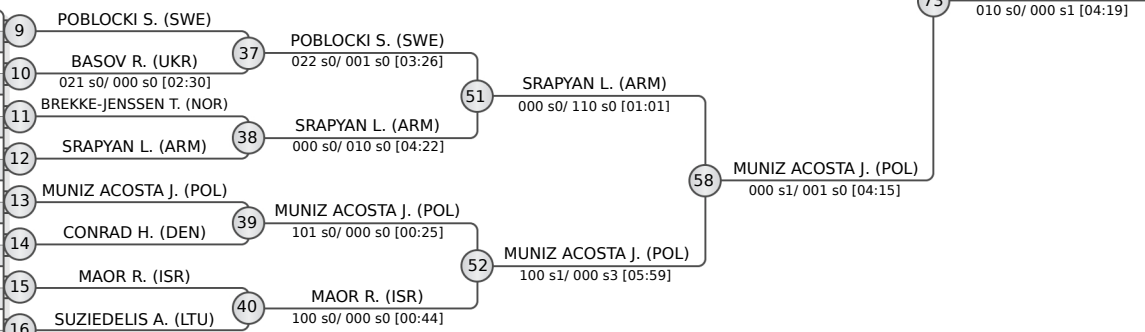

POOL C

	MARTYNCHUK Oleksandr	UKR	17
	ZUGICKIS Markuss	LAT	18
	KAMITSIS Alexandros	CYP	19
	STANEVICIUS Aurimas	LTU	19
	MITCHELL Alfie	GBR	20
	COHEN Itay	ISR	21
	MANOWSKI Dawid	POL	22
	LANGE Marcus	DEN	23
	JACKEVICIUS Rokas	LTU	24

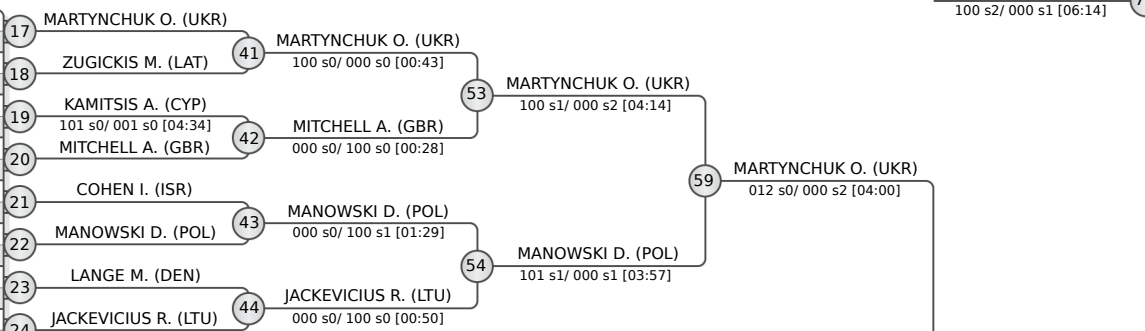

POOL D

	LAURITZEN Magni	DEN	25
	MAKULAVICIUS Rokas	LTU	26
	SIMONOV Yeroslav	ISR	27
	GAVAZZI Romain	FRA	28
	OSTAPENKO Bohdan	UKR	29
	SHATTOCK Jacob	GBR	30
	BEKCHYAN Arshak	ARM	31
	LENARTOWSKI Karol	POL	31
	SADEIKIS Jokubas	LTU	32

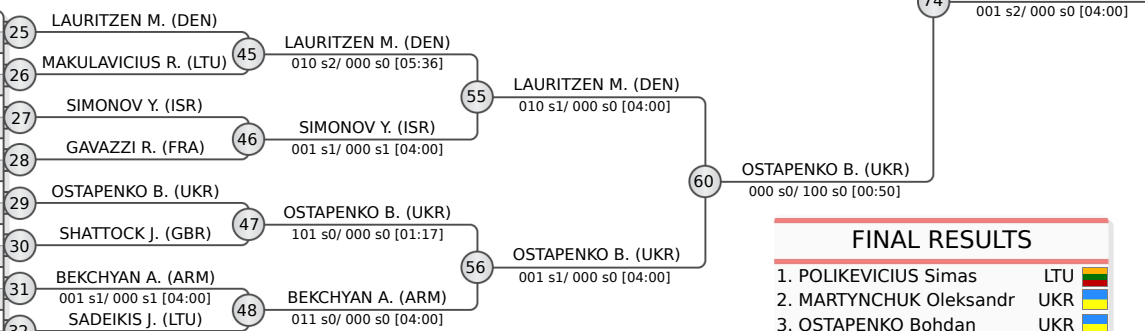

FINAL RESULTS		
1.	POLIKEVICIUS Simas	LTU
2.	MARTYNCHUK Oleksandr	UKR
3.	OSTAPENKO Bohdan	UKR
3.	LAURITZEN Magni	DEN
5.	BIELAN Aristarkh	UKR
5.	MUNIZ ACOSTA Jakub	POL
7.	MAOR Ron	ISR
7.	MANOWSKI Dawid	POL

REPECHAGE

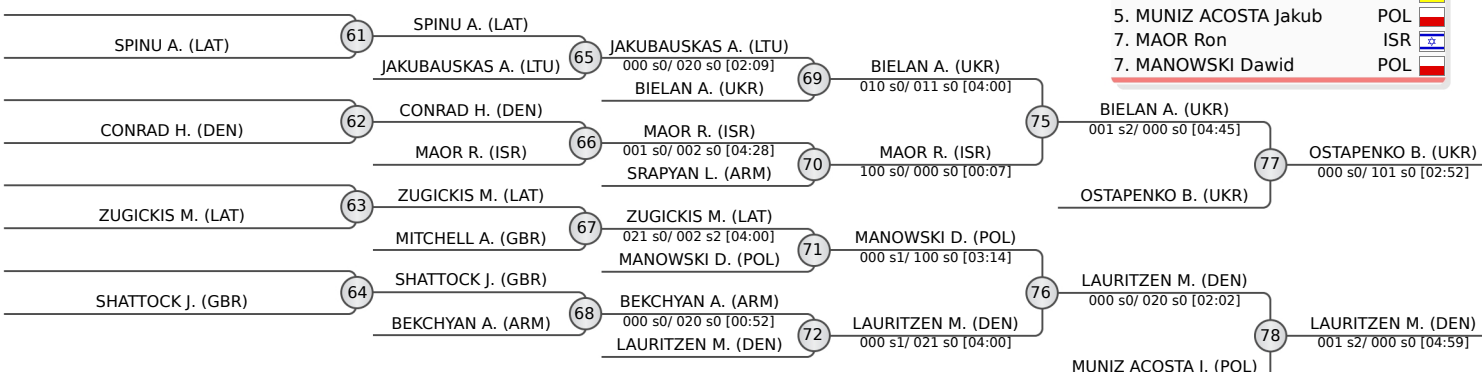



Kaunas Junior European Cup 2026

Lithuania, Kaunas, 25-26 Apr 2026

-73 kg

Juniors (46)

POOL A

1	GBR	GOGINASHVILI Irakli	1	GBR	GOGINASHVILI I. (GBR)
2	CRO	KNEZ Filip	33	CRO	KNEZ F. (CRO)
3	LTU	JOVSA Deividas	34	UKR	MAMADOV D. (UKR)
4	UKR	MAMADOV Davlatzhon	35	POL	PLUTA P. (POL)
5	LAT	PUCITIS Valters	36	FIN	BALAYEV S. (FIN)
6	POL	PLUTA Pawel	37	UKR	NIFTULLAIEV A. (UKR)
7	LAT	ZVANERS Daniels	38	FIN	BALAYEV S. (FIN)
8	LUX	NUNES DOS SANTOS Kevin	39	UKR	NIFTULLAIEV A. (UKR)
9	LTU	NARKUS Girvydas	40	LTU	ALEKSEJUNAS N. (LTU)
10	UKR	NIFTULLAIEV Anar	41	LTU	ALEKSEJUNAS N. (LTU)
11	FIN	BALAYEV Samir	42	LTU	KARALEVICIUS Z. (LTU)

POOL B

9	UKR	LYSENKO Vladyslav	37	UKR	LYSENKO V. (UKR)
10	DEN	NIELSEN Emil	38	GBR	CHRISP J. (GBR)
11	CYP	KURAU LI Iakovos	39	GRE	TSAPARAS K. (GRE)
12	LAT	STRAUSS Fricis Roberts	40	UKR	BANKIN R. (UKR)
13	LTU	RACKA Norbertas	41	LTU	KARALEVICIUS Z. (LTU)
14	GBR	CHRISP Joshua	42	LTU	KARALEVICIUS Z. (LTU)
15	LTU	ALEKSEJUNAS Natas	43	UKR	PRYSHCHEPA A. (UKR)
16	LAT	BIRKHANS Toms Kristians	44	LTU	TONISSON J. (FIN)
17	GRE	TSAPARAS Konstantinos	45	ARM	HAMBARYAN Z. (ARM)
18	LAT	BRIGMANIS-BRIGIS Ernests	46	UKR	MARYNYCH R. (UKR)
19	UKR	BANKIN Roman	47	LTU	MARKSAITIS M. (LTU)
20	LTU	KARALEVICIUS Zygimantas	48	LTU	IVANOVAS M. (LTU)

POOL C

17	SWE	VARDANIAN Narek	41	LTU	KELEVICIUS J. (LTU)
18	LTU	KELEVICIUS Jokubas	42	UKR	PIDKIPNYY G. (UKR)
19	UKR	PIDKIPNYY Glib	43	EST	OTSMANN Ats
20	EST	OTSMANN Ats	44	LAT	LOMONOSOV N. (LAT)
21	LAT	LOMONOSOV N. (LAT)	45	GBR	MACLEOD J. (GBR)
22	GBR	MACLEOD Jack	46	UKR	PRYSHCHEPA A. (UKR)
23	UKR	PRYSHCHEPA Andrii	47	LAT	JAKOVLEVS Edvards
24	UKR	JAKOVLEVS Edvards	48	LAT	HOMKA E. (LAT)
25	LAT	HOMKA Eriks	49	LTU	SALUCKA Tautvydas
26	LAT	SALUCKA Tautvydas	50	FIN	TONISSON J. (FIN)
27	LTU	TONISSON Jonathan	51	UKR	KRAVCHENKO D. (UKR)

POOL D

25	GBR	HEFFERNAN Eden	45	ARM	HAMBARYAN Z. (ARM)
26	DEN	HUNDT Silas	46	UKR	MARYNYCH R. (UKR)
27	ARM	HAMBARYAN Zhirayr	47	LTU	MARKSAITIS M. (LTU)
28	UKR	MARYNYCH Rostyslav	48	LTU	IVANOVAS M. (LTU)
29	LAT	JEKABSONS Bruno	49	UKR	KRAVCHENKO D. (UKR)
30	LTU	MARKSAITIS Matas	50	POL	BLYZNIUK T. (POL)
31	UKR	KRAVCHENKO Danylo	51	CRO	TODOROVIC Ivan
32	UKR	BLYZNIUK Tymur	52	LAT	SAVINS Avivs
33	POL	BLYZNIUK T. (POL)	53	GBR	HILL Kristian
34	CRO	TODOROVIC Ivan	54	LTU	IVANOVAS Mantas
35	LAT	SAVINS Avivs	55	LTU	IVANOVAS M. (LTU)
36	GBR	HILL Kristian	56	LTU	IVANOVAS M. (LTU)
37	LTU	IVANOVAS Mantas	57	LTU	IVANOVAS M. (LTU)

REPECHAGE

61	CRO	KNEZ F. (CRO)	65	UKR	MAMADOV D. (UKR)
62	LAT	KARALEVICIUS Z. (LTU)	66	GRE	TSAPARAS K. (GRE)
63	LTU	KELEVICIUS J. (LTU)	67	UKR	PIDKIPNYY G. (UKR)
64	POL	BLYZNIUK T. (POL)	68	LAT	SAVINS A. (LAT)
65	UKR	MAMADOV D. (UKR)	69	FIN	BALAYEV S. (FIN)
66	LTU	KARALEVICIUS Z. (LTU)	70	GRE	TSAPARAS K. (GRE)
67	LTU	KELEVICIUS J. (LTU)	71	LAT	HOMKA E. (LAT)
68	POL	BLYZNIUK T. (POL)	72	GBR	HEFFERNAN E. (GBR)
69	UKR	MAMADOV D. (UKR)	73	UKR	GOGINASHVILI I. (GBR)
70	GRE	TSAPARAS K. (GRE)	74	UKR	KRAVCHENKO D. (UKR)
71	LAT	HOMKA E. (LAT)	75	UKR	MAMADOV D. (UKR)
72	GBR	HEFFERNAN E. (GBR)	76	GBR	HEFFERNAN E. (GBR)
73	UKR	GOGINASHVILI I. (GBR)	77	UKR	MAMADOV D. (UKR)
74	UKR	KRAVCHENKO D. (UKR)	78	UKR	BANKIN R. (UKR)
75	UKR	MAMADOV D. (UKR)	79	UKR	GOGINASHVILI I. (GBR)

1.	GBR	GOGINASHVILI Irakli
2.	UKR	KRAVCHENKO Danylo
3.	UKR	MAMADOV Davlatzhon
3.	UKR	BANKIN Roman
5.	SWE	VARDANIAN Narek
5.	GBR	HEFFERNAN Eden
7.	GRE	TSAPARAS Konstantinos
7.	LAT	HOMKA Eriks





Kaunas Junior European Cup 2026

Lithuania, Kaunas, 25-26 Apr 2026

-81 kg

Juniors (42)

POOL A

1	DIKAJEV Saad (EST)	DIKAJEV S. (EST)	33	DIKAJEV S. (EST)
2	HAMDAROU Ahmed-Adam (FRA)	PURPISS N. (LAT)		101 s0/ 000 s0 [01:15]
3	PURPISS Nikass (LAT)	000 s0/ 110 s0 [01:05]		
4	NARKUS Vygyrdas (LTU)	NARKUS V. (LTU)		
5	CHEREMKHOV Hryhorii (UKR)	CHEREMKHOV H. (UKR)	34	CHEREMKHOV H. (UKR)
6	MEIER Gabriel (LIE)	MEIER G. (LIE)		000 s2/ 001 s1 [07:39]
7	LAZARIDES Stefanos (CYP)	LAZARIDES S. (CYP)	35	LAZARIDES S. (CYP)
8	ISDAHL Thomas Eriksen (NOR)	ISDAHL T. (NOR)		000 s1/ 001 s0 [04:00]
	BETKOWSKI Milosz (POL)	100 s1/ 000 s1 [02:26]	36	ISDAHL T. (NOR)
	HAIJIYEV Ali (SWE)	HAIJIYEV A. (SWE)		100 s0/ 000 s0 [00:26]

POOL B

9	AVDEJEVS Aleksandrs (LAT)	AVDEJEVS A. (LAT)	37	AVDEJEVS A. (LAT)
10	GAGIN Dovydas (LTU)	BAHNIUK V. (UKR)		100 s0/ 002 s0 [02:31]
11	BAHNIUK Vitalii-Borys (UKR)	000 s0/ 100 s0 [00:17]		
12	PERTELSON Kristofer (FIN)	PERTELSON K. (FIN)		
13	KACZOREK Mikolaj (POL)	002 s1/ 000 s1 [04:00]	38	LEVIN S. (ISR)
14	LEVIN Shahaf (ISR)	LEVIN S. (ISR)		000 s0/ 100 s0 [00:12]
15	SAHIR Stanislav (POL)	SAHIR S. (POL)	39	SAHIR S. (POL)
16	JOLKIN Nikita (EST)	JOLKIN N. (EST)		020 s0/ 000 s2 [03:39]
17	STANKEVICIUS Ignas (LTU)	GRAJFONER N. (SLO)	40	GRAJFONER N. (SLO)
18	GRAJFONER Niko (SLO)	000 s0/ 001 s2 [04:00]		010 s0/ 000 s1 [04:00]
19	MENSHYKOV Vasilij (GBR)	MENSHYKOV V. (GBR)		

POOL C

20	MARLOV Alexander (SWE)	MARLOV A. (SWE)	41	MARLOV A. (SWE)
21	CERNIAVSKIJ Kiril (LTU)	BETKOWSKI J. (POL)		001 s2/ 000 s2 [04:00]
22	BETKOWSKI Jeremiasz (POL)	000 s2/ 100 s1 [03:48]		
23	SVETEC Stas (SLO)	SVETEC S. (SLO)	42	SHNIDERMAN L. (ISR)
24	CHARALAMPOUS Vladimiro (CYP)	100 s0/ 000 s0 [01:42]		000 s1/ 100 s0 [01:18]
25	SHNIDERMAN Liroy (ISR)	SHNIDERMAN L. (ISR)		
26	DAVIES Peter (GBR)	DAVIES P. (GBR)	43	CHARENKA K. (LTU)
27	CHARENKA Kajus (LTU)	CHARENKA K. (LTU)		000 s0/ 010 s0 [05:22]
28	BERG Bert (EST)	BERG B. (EST)	44	CELADINS N. (LAT)
29	SHAPOVALOV Sviatoslav (UKR)	100 s0/ 000 s1 [02:15]		000 s1/ 010 s2 [04:00]
30	CELADINS Nikita (LAT)	CELADINS N. (LAT)		000 s0/ 100 s0 [01:36]

POOL D

31	NIELZIEV Taras (UKR)	NIELZIEV T. (UKR)	45	NIELZIEV T. (UKR)
32	IOANNOU Anastasios (CYP)	IOANNOU A. (CYP)		100 s0/ 000 s0 [00:12]
33	GENEVICIUS Tajus (LTU)	BENKOV O. (POL)	46	SALAH M. (FRA)
34	BENKOV Oleksandr (POL)	000 s0/ 101 s0 [00:54]		000 s1/ 020 s2 [02:14]
35	SALAH Mehdi (FRA)	SALAH M. (FRA)		
36	BRZUSZCZYNSKI Szymon (POL)	BRZUSZCZYNSKI S. (POL)	47	KARAKIN S. (UKR)
37	KARAKIN Serhii (UKR)	KARAKIN S. (UKR)		000 s0/ 020 s0 [00:31]
38	KASESALU Christian-Marcus (EST)	KASESALU C. (EST)	48	PAVARS M. (LAT)
39	HONKATUKIA Toivo (FIN)	100 s0/ 000 s0 [02:47]		000 s0/ 001 s0 [05:13]
40	PAVARS Markuss (LAT)	PAVARS M. (LAT)		

REPECHAGE

61	PURPISS N. (LAT)	65	CHEREMKHOV H. (UKR)	69	CHEREMKHOV H. (UKR)
62	JOLKIN N. (EST)	66	GRAJFONER N. (SLO)	70	AVDEJEVS A. (LAT)
63	BERG B. (EST)	67	BERG B. (EST)	71	MARLOV A. (SWE)
64	BRZUSZCZYNSKI S. (POL)	68	BRZUSZCZYNSKI S. (POL)	72	NIELZIEV T. (UKR)
				73	SAHIR S. (POL)
				74	KARAKIN S. (UKR)
				75	AVDEJEVS A. (LAT)
				76	MARLOV A. (SWE)
				77	AVDEJEVS A. (LAT)
				78	DIKAJEV S. (EST)

FINAL RESULTS	
1.	KARAKIN Serhii (UKR)
2.	SAHIR Stanislav (POL)
3.	AVDEJEVS Aleksandrs (LAT)
3.	DIKAJEV Saad (EST)
5.	CELADINS Nikita (LAT)
5.	MARLOV Alexander (SWE)
7.	CHEREMKHOV Hryhorii (UKR)
7.	NIELZIEV Taras (UKR)





Kaunas Junior European Cup 2026

Lithuania, Kaunas, 25-26 Apr 2026

-90 kg

Juniors (23)

POOL A

	JABIYEV Emil	SWE
	BILOUS Illia	UKR
	FIODOROVAS Joris	LTU
	PILECKAS Aidas	LTU
	KRAUSS Jan	POL
	BESSOLCEVS Pavels	LAT

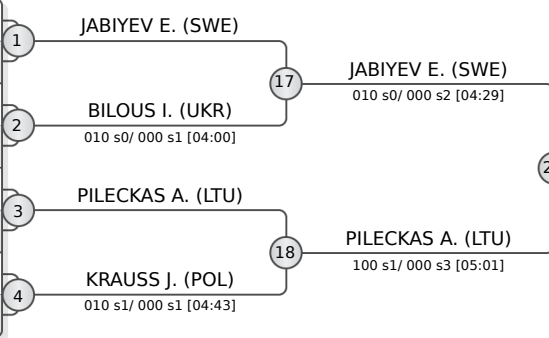

POOL B

	PEREVERTAILO Kyrylo	UKR
	JACENKO Arturs	LAT
	TATARU Archili	GBR
	KOMIN Kirill	EST
	KAIS Rayan	FRA
	MIKUTAITIS Mantas	LTU

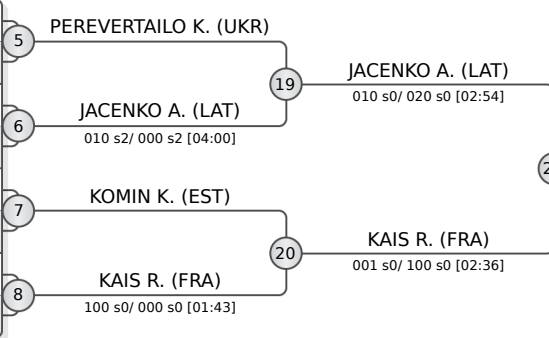

POOL C

	SOKYRKO Serhii	UKR
	HULIN Kamil	POL
	DARULIS Arturas	LTU
	KHOROSHAILOV Mykhailo	UKR
	CHARALAMPOUS Miltiadis	CYP
	KULLO Tits	LAT

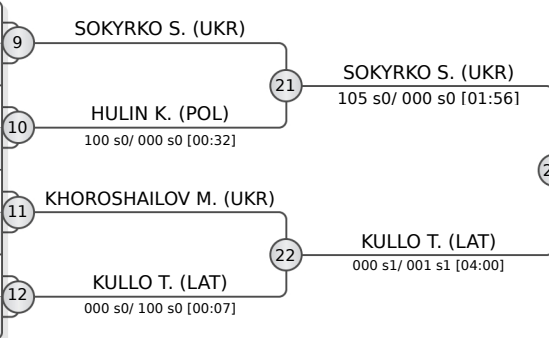

POOL D

	GHAFOORIRAD Arad	GBR
	KHATCHATOURIAN David	LTU
	MANFELDS Tomass	LAT
	ANDZYAN Minas	FRA
	POLISHCHUK Matfei	FIN

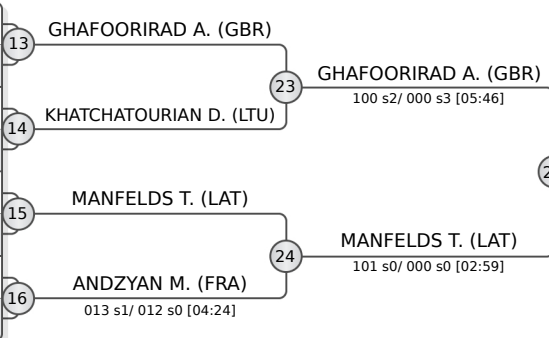

REPECHAGE

29	BILOUS I. (UKR)
30	KOMIN K. (EST)
31	HULIN K. (POL)
32	ANDZYAN M. (FRA)

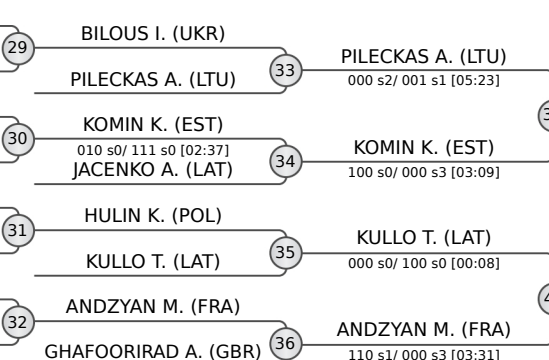

FINAL RESULTS	
1.	SOKYRKO Serhii
2.	JABIYEV Emil
3.	MANFELDS Tomass
3.	KAIS Rayan
5.	PILECKAS Aidas
5.	KULLO Tits
7.	KOMIN Kirill
7.	ANDZYAN Minas





Kaunas Junior European Cup 2026

Lithuania, Kaunas, 25-26 Apr 2026

-100 kg

Juniors (19)

POOL A

	GORDON Kevin	GBR	1	GORDON K. (GBR)	
	JIKIA Saba	GEO	2	JIKIA S. (GEO)	
	UZAN Amit Amos	ISR	3	UZAN A. (ISR)	
	YAKYMENKO Illia	UKR	4	YAKYMENKO I. (UKR)	
					17
					JIKIA S. (GEO)
					000 s1/ 020 s0 [03:49]
					18
					UZAN A. (ISR)
					111 s0/ 000 s3 [02:27]

POOL B

	GENYS Majus	LTU	5	GENYS M. (LTU)	
	MAHAMEED Vincent	POL	6	MAHAMEED V. (POL)	
	STROMSTEDT Rasmus	SWE	7	STROMSTEDT R. (SWE)	
	CALDER Jaden	GBR	7	CALDER J. (GBR)	
	WELTER Micha	LUX	8	WELTER M. (LUX)	
					19
					GENYS M. (LTU)
					100 s0/ 000 s0 [00:46]
					20
					WELTER M. (LUX)
					001 s0/ 012 s1 [04:00]

POOL C

	HARMASH Ivan	UKR	9	HARMASH I. (UKR)	
	KERNOSENKO Lev	POL	10	DA CRUZ M. (LUX)	
	DA CRUZ Matteo	LUX	10	DA CRUZ M. (LUX)	
	ANTHONI Oliver	FIN	11	ANTHONI O. (FIN)	
	TWITO Ilan	ISR	12	TWITO I. (ISR)	
					21
					HARMASH I. (UKR)
					101 s0/ 000 s0 [00:56]
					22
					ANTHONI O. (FIN)
					020 s0/ 000 s1 [03:38]

POOL D

	KOORT Ken-Kermo	EST	13	KOORT K. (EST)	
	TATARU Gheorghe	GBR	14	TATARU G. (GBR)	
	TOMASZKIEWICZ Justus	POL	15	TOMASZKIEWICZ J. (POL)	
	SHYSHOV Mykhailo	UKR	16	SHYSHOV M. (UKR)	
	ANUZYS Edvinas	LTU	16	ANUZYS E. (LTU)	
					23
					TATARU G. (GBR)
					000 s0/ 010 s1 [04:00]
					24
					TOMASZKIEWICZ J. (POL)
					101 s0/ 000 s0 [01:07]

REPECHAGE

					29	GORDON K. (GBR)	
					30	MAHAMEED V. (POL)	
					31	DA CRUZ M. (LUX)	
					32	SHYSHOV M. (UKR)	
					33	UZAN A. (ISR)	
					34	WELTER M. (LUX)	
					35	DA CRUZ M. (LUX)	
					36	TATARU G. (GBR)	
					37	GENYS M. (LTU)	
					38	HARMASH I. (UKR)	
					39	WELTER M. (LUX)	
					40	TATARU G. (GBR)	
					41	WELTER M. (LUX)	
					42	JIKIA S. (GEO)	
					43	HARMASH I. (UKR)	

FINAL RESULTS	
1.	HARMASH Ivan
2.	GENYS Majus
3.	WELTER Micha
3.	JIKIA Saba
5.	TOMASZKIEWICZ Justus
5.	TATARU Gheorghe
7.	UZAN Amit Amos
7.	DA CRUZ Matteo





Kaunas Junior European Cup 2026

Lithuania, Kaunas, 25-26 Apr 2026

+100 kg

Juniors (12)

POOL A

	MASAK Marek-Adrian	EST
	PIKAUSKAS Kipras	LTU
	VILCINSKAS Garblielius	LTU

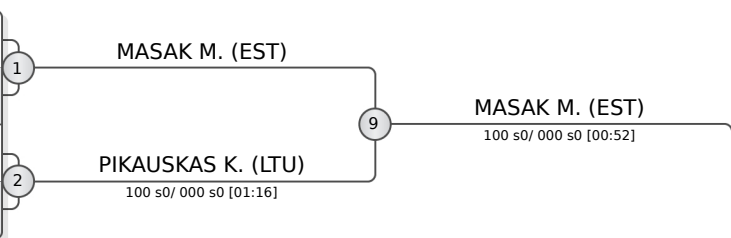

POOL B

	STREMAUSKAS Mykolas	LTU
	MASTEIKA Titas	LTU
	NARVA Miska	FIN

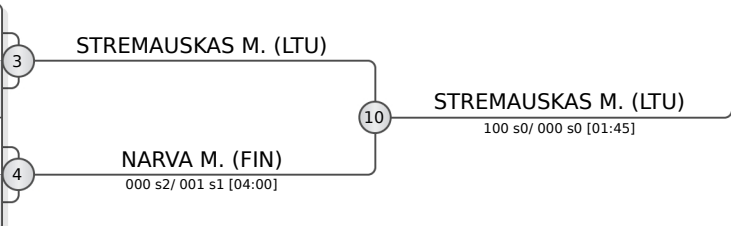

POOL C

	CHAMERSKI Daniel	POL
	STIVENSON Arthur	CAN
	GURSKIJ Gabriel	LTU

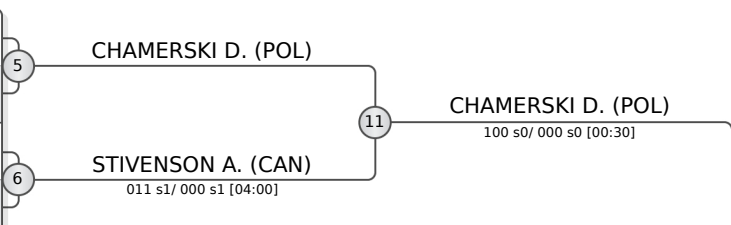

POOL D

	KHACHATRYAN Anton	POL
	KLIMCIAUSKAS Antanas	LTU
	PALEICIKAS Nikolas	LTU

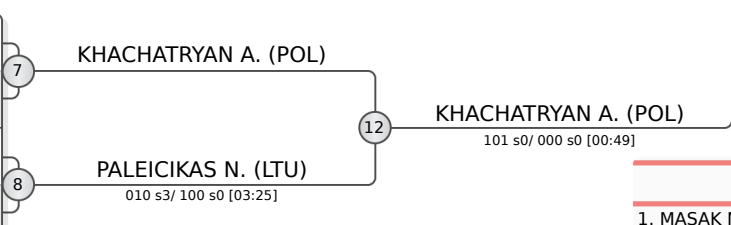

REPECHAGE

PIKAUSKAS K. (LTU)	13
NARVA M. (FIN)	14
STIVENSON A. (CAN)	15
PALEICIKAS N. (LTU)	16

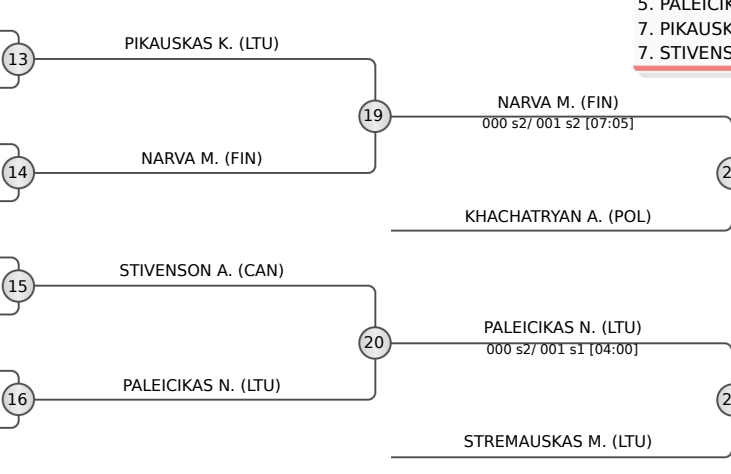

FINAL RESULTS		
1.	MASAK Marek-Adrian	EST
2.	CHAMERSKI Daniel	POL
3.	KHACHATRYAN Anton	POL
3.	STREMAUSKAS Mykolas	LTU
5.	NARVA Miska	FIN
5.	PALEICIKAS Nikolas	LTU
7.	PIKAUSKAS Kipras	LTU
7.	STIVENSON Arthur	CAN





Kaunas Junior European Cup 2026

Lithuania, Kaunas, 25-26 Apr 2026

-48 kg

Juniors (13)

POOL A

	WALENDZIK Sandra	POL
	PETRENKO Liliia	UKR
	BROVOLD Selma	NOR

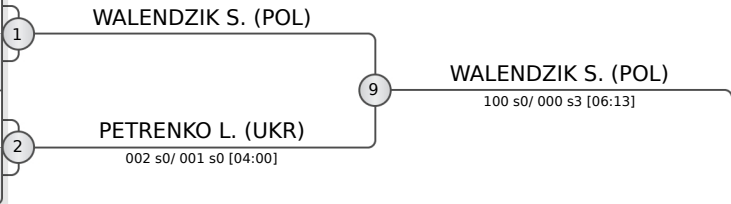

POOL B

	EWING Eva	GBR
	LUKASHEVSKA Nadiia	LTU
	GABAY Yuval	ISR
	LISOHOROVA Alona	UKR

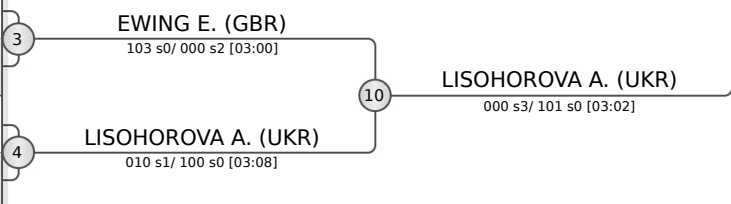

POOL C

	SHLAYFER Liah	ISR
	VALCHENKO Valeriia	UKR
	BUSAUSKAITE Migle	LTU

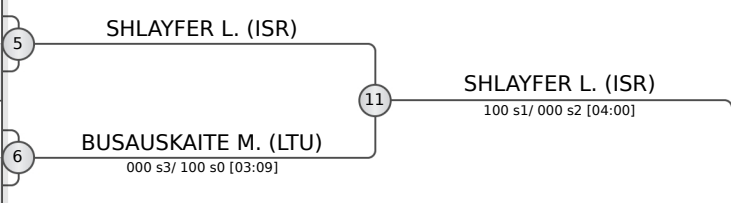

POOL D

	POTOK Natasza	POL
	KUTENKOVA Mariia	UKR
	OMELCHENKO Kateryna	LTU

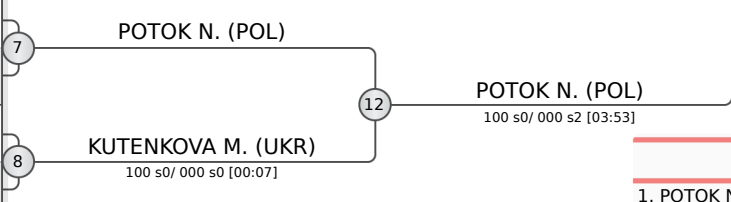

REPECHAGE

PETRENKO L. (UKR)	13
GABAY Y. (ISR)	14
EWING E. (GBR)	14
BUSAUSKAITE M. (LTU)	15
KUTENKOVA M. (UKR)	16

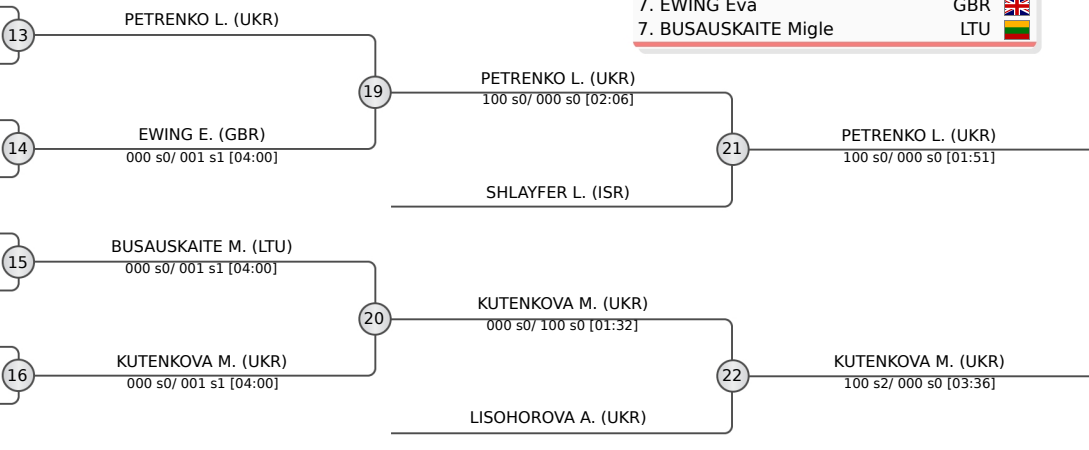

FINAL RESULTS		
1.	POTOK Natasza	POL
2.	WALENDZIK Sandra	POL
3.	PETRENKO Liliia	UKR
3.	KUTENKOVA Mariia	UKR
5.	SHLAYFER Liah	ISR
5.	LISOHOROVA Alona	UKR
7.	EWING Eva	GBR
7.	BUSAUSKAITE Migle	LTU





Kaunas Junior European Cup 2026

Lithuania, Kaunas, 25-26 Apr 2026

-52 kg

Juniors (18)

POOL A

	HODSON Lola	GBR	1	HODSON L. (GBR)
	CESLAUSKAITE Deimante	LTU	2	CESLAUSKAITE D. (LTU)
	GRZESZCZYK Otylia	POL	3	GRZESZCZYK O. (POL)
	TUZ Diana	UKR	4	TUZ D. (UKR)

POOL B

	MIROSHNICHENKO Marharyta	UKR	5	MIROSHNICHENKO M. (UKR)
	POTOK Nina	POL	6	POTOK N. (POL)
	KYRYLIUK Tetiana	POL	7	KYRYLIUK T. (POL)
	HOLLANDER Liya	ISR	8	HOLLANDER L. (ISR)
	HODGKINSON Daisy	GBR	8	HODGKINSON D. (GBR)

POOL C

	CHISHOLM Kate	GBR	9	CHISHOLM K. (GBR)
	GRAY Rachael	GBR	10	GRAY R. (GBR)
	LAPPETELAINEN Essi	FIN	10	LAPPETELAINEN E. (FIN)
	YEMELIANOVA Yelyzaveta	UKR	11	YEMELIANOVA Y. (UKR)
	BOROWICZ Anna	POL	12	BOROWICZ A. (POL)

POOL D

	JESIONEK Maria	POL	13	JESIONEK M. (POL)
	CHRISTODOULIDOU Adamantia	CYP	14	CHRISTODOULIDOU A. (CYP)
	ALDER Amelia	GBR	15	ALDER A. (GBR)
	HRECHKA Sofia	UKR	16	HRECHKA S. (UKR)

REPECHAGE

	CESLAUSKAITE D. (LTU)	29	CESLAUSKAITE D. (LTU)	33	TUZ D. (UKR)
					000 s0/ 100 s0 [01:37]
	POTOK N. (POL)	30	POTOK N. (POL)	34	KYRYLIUK T. (POL)
					000 s1/ 001 s1 [04:00]
	LAPPETELAINEN E. (FIN)	31	LAPPETELAINEN E. (FIN)	35	LAPPETELAINEN E. (FIN)
					002 s0/ 001 s0 [04:11]
	ALDER A. (GBR)	32	ALDER A. (GBR)	36	ALDER A. (GBR)
					101 s1/ 000 s2 [04:00]

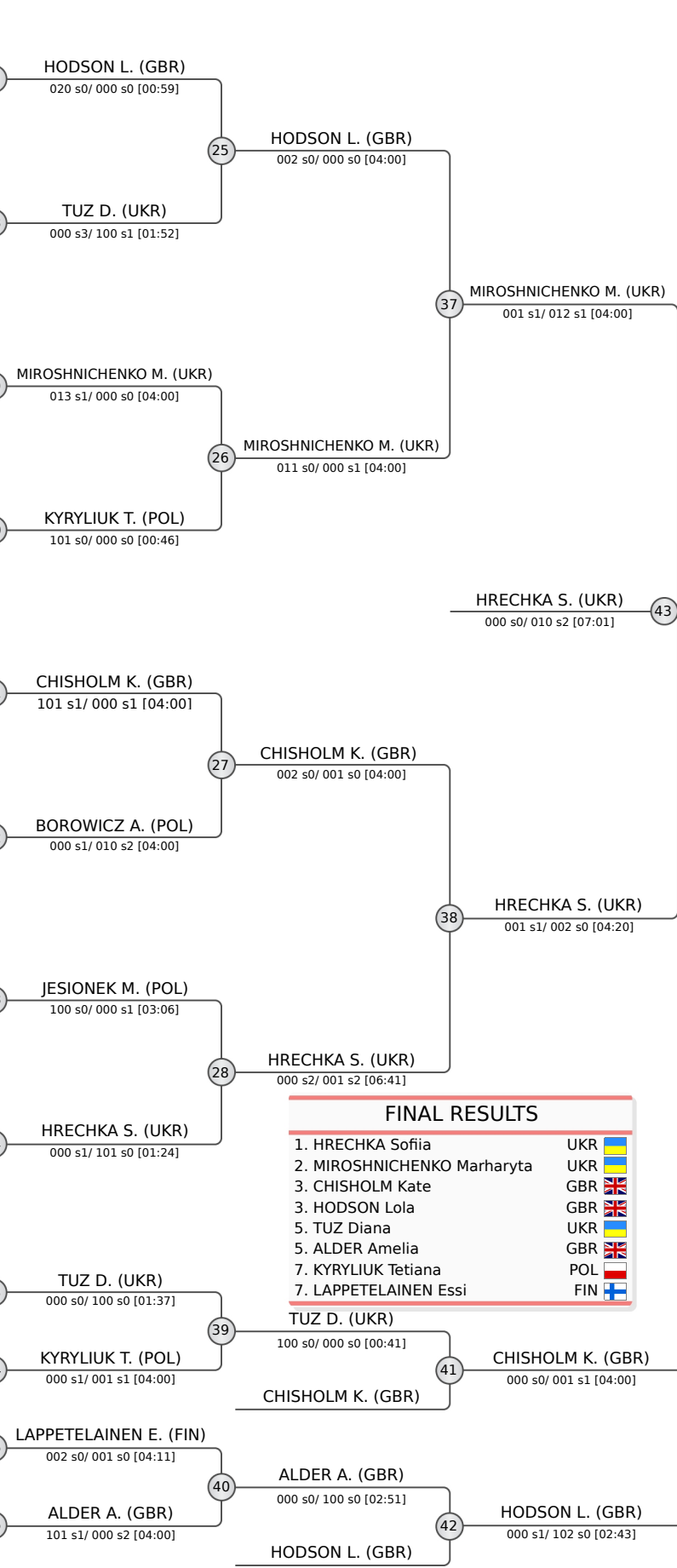

FINAL RESULTS	
1.	HRECHKA Sofia
2.	MIROSHNICHENKO Marharyta
3.	CHISHOLM Kate
3.	HODSON Lola
5.	TUZ Diana
5.	ALDER Amelia
7.	KYRYLIUK Tetiana
7.	LAPPETELAINEN Essi





Kaunas Junior European Cup 2026

Lithuania, Kaunas, 25-26 Apr 2026

-57 kg

Juniors (23)

POOL A

	KUCHAR Varvara	LTU
	AVDIC Leila	SWE
	GEV Shira	ISR
	KERGALVE Viktorija	LAT
	KOLAKOWSKA Zuzanna	POL

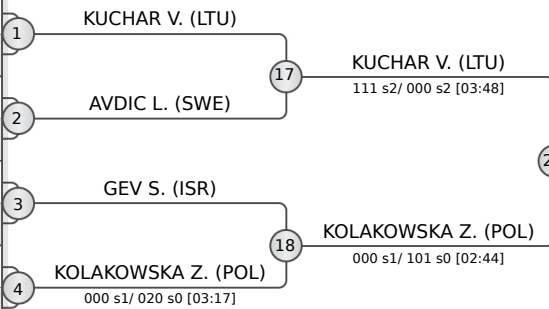

POOL B

	SEVERYN Anastasiia	UKR
	GRAJAUSKAITE Samanta	LTU
	SASSEN Hailey	SWE
	KUCHARZ Maja	POL
	PINDER Rhea	GBR
	PYYKONEN Iida	FIN

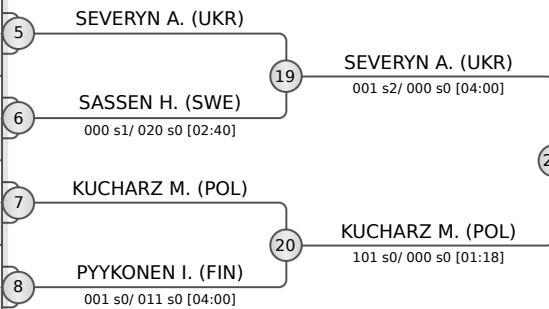

POOL C

	GAIGALAITE Monika	LTU
	LOMVIK Ida	SWE
	JONES Harriet	GBR
	KARJALAINEN Ella	FIN
	BOIKO Veronika	UKR
	KOWALSKA Anna	POL

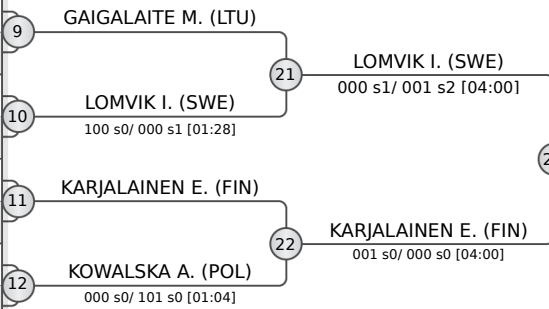

POOL D

	MOS Marika	POL
	KISSENISKY Maddy	GBR
	SCHEINER Gal	ISR
	BABULFATH Hanna	SWE
	KARNA Olivia	FIN
	ZARUBA Viktorija	LTU

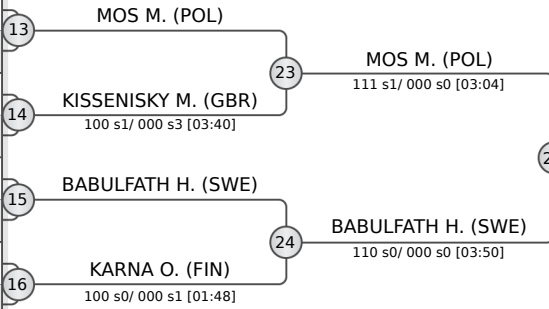

REPECHAGE

AVDIC L. (SWE)	29	AVDIC L. (SWE)	33
PYYKONEN I. (FIN)	30	SEVERYN A. (UKR)	34
KOWALSKA A. (POL)	31	LOMVIK I. (SWE)	35
KISSENISKY M. (GBR)	32	BABULFATH H. (SWE)	36

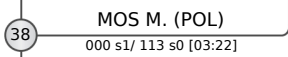
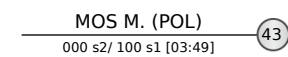
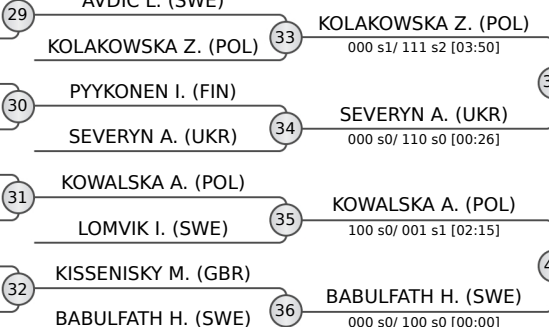

FINAL RESULTS	
1. MOS Marika	POL
2. KUCHARZ Maja	POL
3. KOLAKOWSKA Zuzanna	POL
3. KUCHAR Varvara	LTU
5. KARJALAINEN Ella	FIN
5. BABULFATH Hanna	SWE
7. SEVERYN Anastasiia	UKR
7. KOWALSKA Anna	POL

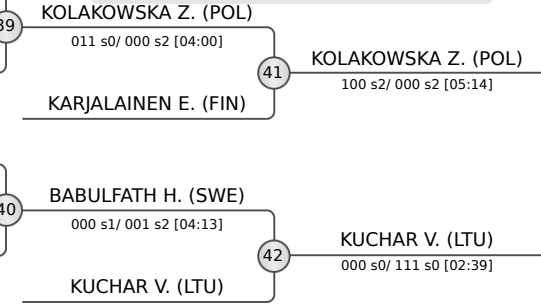



Kaunas Junior European Cup 2026

Lithuania, Kaunas, 25-26 Apr 2026

-63 kg

Juniors (21)

POOL A

	OPANASENKO Kristina	UKR	1	OPANASENKO K. (UKR)
	SOPAITE Iruna	LTU	2	POPOVIC K. (CRO)
	POPOVIC Kaja	CRO		000 s0/ 100 s0 [01:32]
	BADASH Naama	ISR	3	BADASH N. (ISR)
	CINIKAITE Liepa	LTU	4	CINIKAITE L. (LTU)

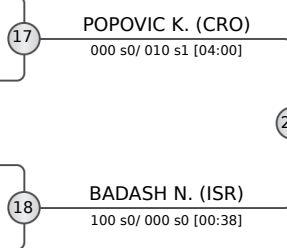

POOL B

	PEKKI Sofia	FIN	5	PEKKI S. (FIN)
	KORDEL Mira	SWE	6	KORDEL M. (SWE)
	BAGNIEWSKA Amelia	POL	7	BAGNIEWSKA A. (POL)
	YAHIAIEVA Aishe	UKR	8	JUSEVICIUTE R. (LTU)
	JUSEVICIUTE Radvile	LTU		000 s0/ 110 s0 [01:58]

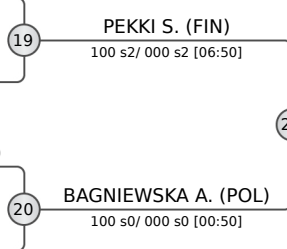

POOL C

	MOCANOSKI Andrea	SWE	9	MOCANOSKI A. (SWE)
	ANDRIULIONYTE Auste	LTU	10	ANDRIULIONYTE A. (LTU)
	MCGILL Bronach Mary	GBR		100 s1/ 000 s3 [02:25]
	TENHU Elsa	FIN	11	TENHU E. (FIN)
	TRAAVIK Asal	NOR	12	BOICHENKO D. (UKR)
	BOICHENKO Daria	UKR		000 s0/ 100 s0 [01:26]

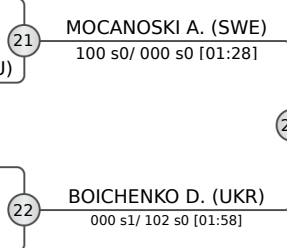

POOL D

	SKERYTE Ugne	LTU	13	SKERYTE U. (LTU)
	MANDRYKA Anhelina	UKR	14	MANDRYKA A. (UKR)
	GALLUDEC Emmy	FRA	15	GALLUDEC E. (FRA)
	SIMANSKAJA Viktorija	LTU	16	NARVA A. (FIN)
	NARVA Ada-Alexia	FIN		000 s2/ 100 s0 [03:12]

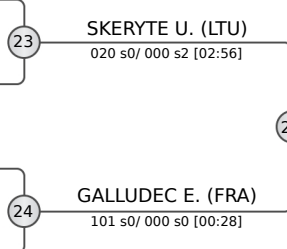

REPECHAGE

CINIKAITE L. (LTU)	29	CINIKAITE L. (LTU)	33	CINIKAITE L. (LTU)	100 s0/ 011 s0 [02:02]
KORDEL M. (SWE)	30	KORDEL M. (SWE)	34	KORDEL M. (SWE)	100 s2/ 000 s1 [08:08]
TRAAVIK A. (NOR)	31	TENHU E. (FIN)	35	MOCANOSKI A. (SWE)	000 s0/ 020 s0 [01:56]
TENHU E. (FIN)		000 s1/ 001 s2 [07:14]			
NARVA A. (FIN)	32	NARVA A. (FIN)	36	SKERYTE U. (LTU)	000 s3/ 100 s1 [02:36]
		SKERYTE U. (LTU)			

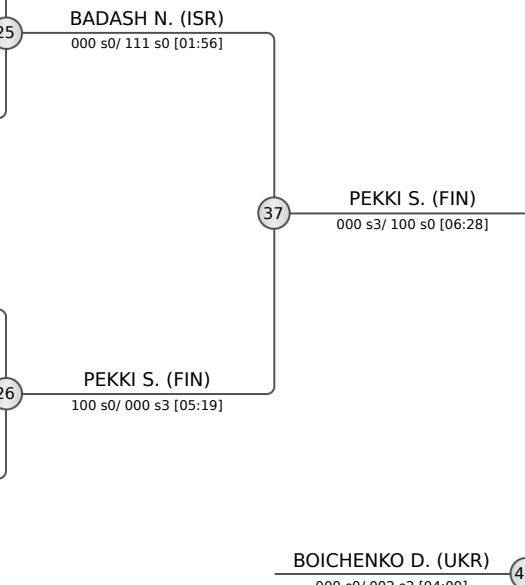

FINAL RESULTS	
1.	BOICHENKO Daria
2.	PEKKI Sofia
3.	GALLUDEC Emmy
3.	SKERYTE Ugne
5.	KORDEL Mira
5.	BADASH Naama
7.	CINIKAITE Liepa
7.	MOCANOSKI Andrea





Kaunas Junior European Cup 2026

Lithuania, Kaunas, 25-26 Apr 2026

-70 kg

Juniors (19)

POOL A

	PTASINSKA Amelia	POL
	JAMER Lara	SLO
	RAGAUŠKAITE Viktorija	LTU
	EHMSEN Karen	DEN
	GRAMBO Anna	NOR

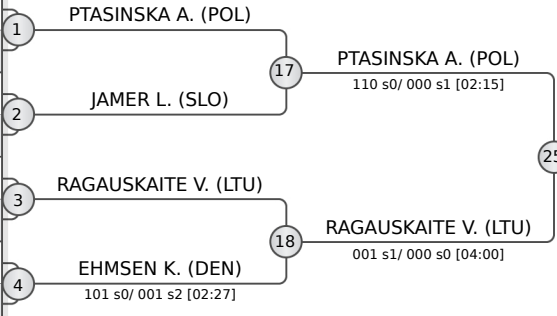

POOL B

	VOZNIUK Liudmyla	UKR
	PIETRZAK Gabriela	POL
	NAVICKAITE Marta	LTU
	JOHANSSON Ronja	SWE

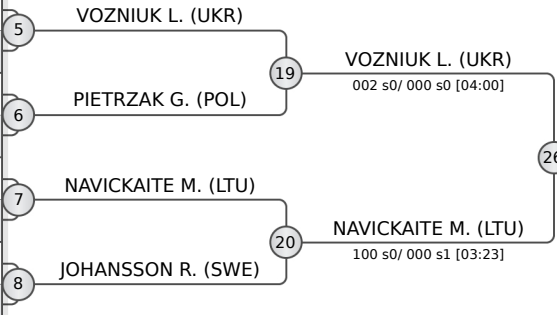

POOL C

	SUTOVIC Andrijana	MNE
	DESIATNYK Karina	UKR
	MARTINKUTE Kamile	LTU
	SUCIU Anamaria	ROU
	SEMETE Karina	GBR

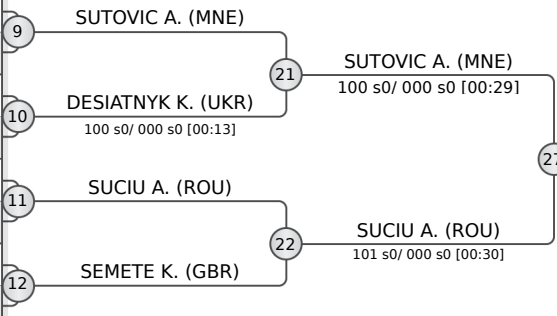

POOL D

	POGOSYAN Gayane	EST
	SEIKKULA Pihla-Maria	FIN
	SCHENK Magdalena	POL
	WELTER Leni	LUX
	JONUSAITE Ieva	LTU

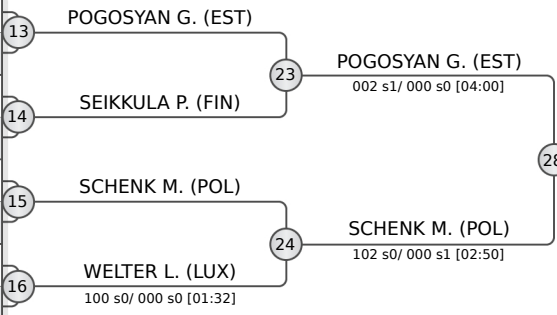

REPECHAGE

JAMER L. (SLO) (29)	JAMER L. (SLO)	33	RAGAUŠKAITE V. (LTU)
JOHANSSON R. (SWE) (30)	JOHANSSON R. (SWE)	34	VOZNIUK L. (UKR)
DESIATNYK K. (UKR) (31)	DESIATNYK K. (UKR)	35	SUCIU A. (ROU)
SEIKKULA P. (FIN) (32)	SEIKKULA P. (FIN)	36	SCHENK M. (POL)

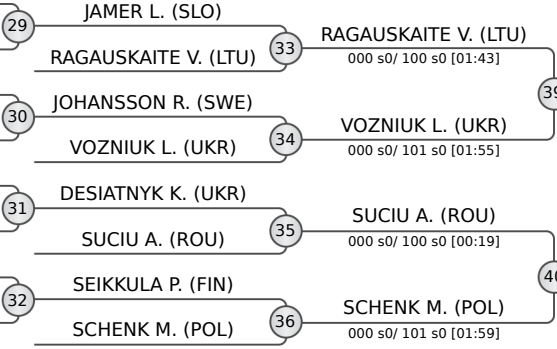

FINAL RESULTS		
1.	POGOSYAN Gayane	EST
2.	PTASINSKA Amelia	POL
3.	SUTOVIC Andrijana	MNE
3.	SCHENK Magdalena	POL
5.	VOZNIUK Liudmyla	UKR
7.	NAVICKAITE Marta	LTU
7.	RAGAUŠKAITE Viktorija	LTU
7.	SUCIU Anamaria	ROU





Kaunas Junior European Cup 2026

Lithuania, Kaunas, 25-26 Apr 2026

-78 kg

Juniors (8)

POOL A

	WOOD Nicole	GBR
	CERRO Isona	AND

1
WOOD N. (GBR)
020 s0/ 000 s0 [01:06]

POOL B

	DOLIA Daria	UKR
	WIDLAK Nicole	POL

2
WIDLAK N. (POL)
000 s0/ 100 s0 [00:00]

POOL C

	GLUBIAK Magda	POL
	EININGE Saule	LTU

3
GLUBIAK M. (POL)
001 s1/ 000 s1 [06:58]

POOL D

	AJDUKOVIC Antea	CRO
	BUTKUTE Regvita	LTU

4
AJDUKOVIC A. (CRO)
101 s0/ 000 s2 [02:44]

5
WOOD N. (GBR)
100 s1/ 000 s3 [05:04]

6
GLUBIAK M. (POL)
001 s1/ 000 s1 [04:00]

11
GLUBIAK M. (POL)
000 s2/ 100 s1 [04:43]

FINAL RESULTS		
1.	GLUBIAK Magda	POL
2.	WOOD Nicole	GBR
3.	AJDUKOVIC Antea	CRO
3.	WIDLAK Nicole	POL
5.	CERRO Isona	AND
5.	EININGE Saule	LTU

REPECHAGE

7
CERRO I. (AND)
DOLIA D. (UKR)

CERRO I. (AND)
100 s0/ 000 s0 [00:00]

8
EININGE S. (LTU)
BUTKUTE R. (LTU)

8
EININGE S. (LTU)
100 s0/ 010 s0 [02:06]

9
AJDUKOVIC A. (CRO)
000 s0/ 100 s0 [01:05]

10
WIDLAK N. (POL)
000 s0/ 100 s0 [01:05]

