



Prague Junior European Cup 2026

Czechia, Prague, 4-5 Jul 2026

-60 kg

Juniors (41)

POOL A

1	USA	YANG Jonathan	YANG J. (USA)
2	AZE	MIRZAZADA Aykhan	MIRZAZADA A. (AZE)
3	BUL	MARTINOV Tsvetelin	JAKL M. (CZE)
4	ITA	KIRIELEISON Francesco	KIRIELEISON F. (ITA)
5	UKR	AVRAMENKO Danylo	AVRAMENKO D. (UKR)
6	ITA	MOGLIA Riccardo	DOSBERGEN N. (KAZ)
7	KAZ	DOSBERGEN Nurdos	CRUZ G. (BRA)
8	BRA	CRUZ Gabriel	BERGER A. (GER)
8	GER	BERGER Arthur	BERGER A. (GER)

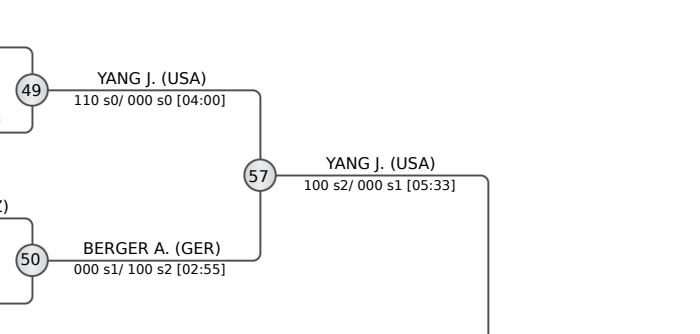

POOL B

9	BRA	OLIVEIRA Vinicius	OLIVEIRA V. (BRA)
10	CAN	BROUILLETTE Xavier	BROUILLETTE X. (CAN)
11	ITA	PELLIZZARO Mattia	PELLIZZARO M. (ITA)
12	KOR	KIM Dongjun	SPICKA M. (CZE)
13	CZE	SPICKA Matej	TINELLI M. (ITA)
14	ITA	TINELLI Mario	OMANADZE L. (GEO)
15	GEO	OMANADZE Luka	KONYSBAY A. (KAZ)
16	FRA	MEREO Alexi	KONYSBAY A. (KAZ)
16	KAZ	KONYSBAY Altynbek	BUCHANAN J. (GBR)
16	GBR	BUCHANAN Joseph	BUCHANAN J. (GBR)

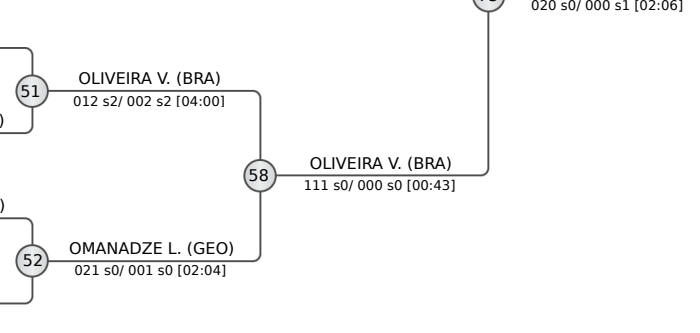

POOL C

17	AUS	LEE Casey	LEE C. (AUS)
18	LTU	ZUKAUSKAS Matas	REIS A. (POR)
19	POR	REIS Afonso	SILVA V. (BRA)
20	BRA	SILVA Victor Hugo	SILVA V. (BRA)
21	ITA	SANDRINI Angelo Karol	GHEORGHIU D. (GBR)
22	GBR	GHEORGHIU David	ZHENGISSULY K. (KAZ)
23	KAZ	ZHENGISSULY Kairat	CAVALJI S. (CZE)
24	ITA	GUALANDI Matteo	CAVALJI S. (CZE)
24	CZE	CAVALJI Serghei	KALIASHVILI L. (GEO)
24	GEO	KALIASHVILI Luka	SASSI T. (ITA)
24	ITA	SASSI Thomas	SASSI T. (ITA)

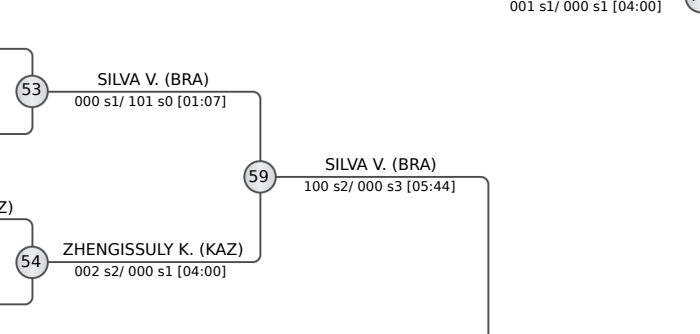

POOL D

25	ITA	CROCIANI Francesco	CROCIANI F. (ITA)
26	SUI	CORI Silvano	CORI S. (SUI)
27	KAZ	ABDIMANAP Akezhan	ABDIMANAP A. (KAZ)
28	CAN	BEATON Loic	TONO T. (USA)
29	USA	TONO Trent	TONO T. (USA)
30	GEO	BACHOSHVILI Shota	BACHOSHVILI S. (GEO)
31	BRA	RODRIGUES Joao	RODRIGUES J. (BRA)
32	GRE	MAVRIDIS Leonidas	RODRIGUES J. (BRA)
32	ITA	CHIARELLA Luca	CHIARELLA L. (ITA)
32	SVK	BILKA Oliver	BILKA O. (SVK)

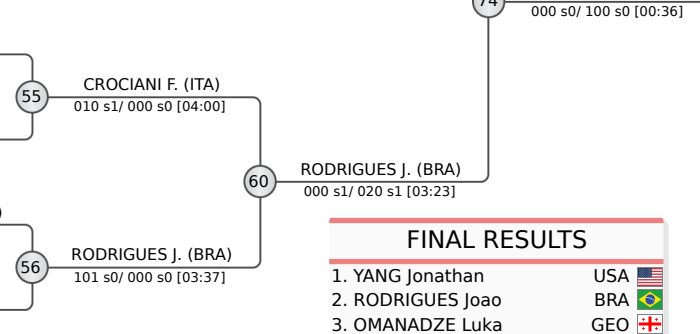

FINAL RESULTS		
1.	YANG Jonathan	USA
2.	RODRIGUES Joao	BRA
3.	OMANADZE Luka	GEO
3.	OLIVEIRA Vinicius	BRA
5.	SILVA Victor Hugo	BRA
5.	ZHENGISSULY Kairat	KAZ
7.	BERGER Arthur	GER
7.	CROCIANI Francesco	ITA

REPECHAGE

61	MIRZAZADA A. (AZE)	65	MIRZAZADA A. (AZE)	69	BERGER A. (GER)
62	BROUILLETTE X. (CAN)	66	BROUILLETTE X. (CAN)	70	OMANADZE L. (GEO)
63	SANDRINI A. (ITA)	67	REIS A. (POR)	71	ZHENGISSULY K. (KAZ)
64	BACHOSHVILI S. (GEO)	68	CHIARELLA L. (ITA)	72	CROCIANI F. (ITA)

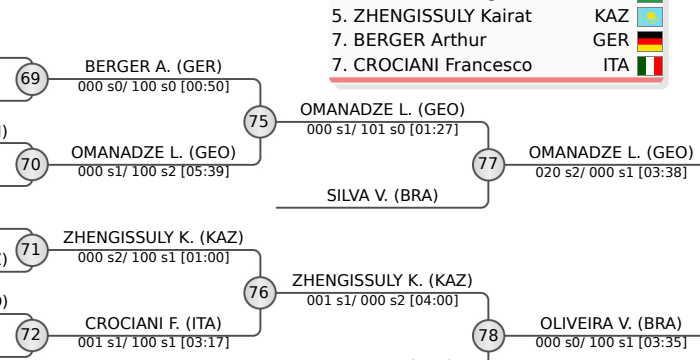



Prague Junior European Cup 2026

Czechia, Prague, 4-5 Jul 2026

-66 kg

Juniors (41)

POOL A

MUSAYEV Mahammad AZE	1	MUSAYEV M. (AZE)	
TERTULIANO Gustavo BRA	2	TERTULIANO G. (BRA)	33
FIGUEIREDO Manuel POR	3	FIGUEIREDO M. (POR)	
JACKEVICIUS Rokas LTU		100 s0/ 000 s1 [00:56]	
ESPOSITO Antonio ITA	4	ESPOSITO A. (ITA)	34
ABYL Dias KAZ	5	ABYL D. (KAZ)	
SABASHVILI Saba GEO	6	SABASHVILI S. (GEO)	35
MILJIC Srdjan SRB	7	MILJIC S. (SRB)	
DISCOLO Davide ITA		021 s1/ 001 s1 [02:58]	
OSTAPENKO Bohdan UKR	8	OSTAPENKO B. (UKR)	36
		000 s1/ 003 s0 [04:00]	

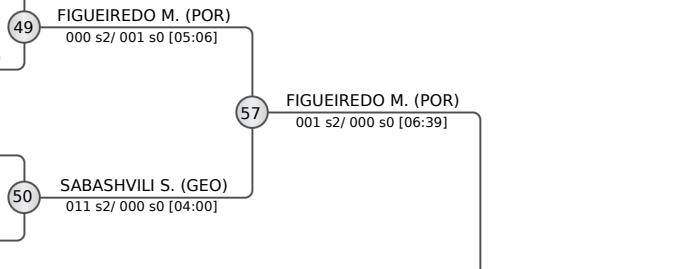

POOL B

MARTYNCHUK Oleksandr UKR	9	MARTYNCHUK O. (UKR)	
GHIDONI Thomas ITA	10	GHIDONI T. (ITA)	37
COHEN Adrian USA	11	MIVOVAN A. (FRA)	
MIVOVAN Adrian FRA		000 s1/ 021 s0 [02:39]	
ROZGA Roko CRO	12	ROZGA R. (CRO)	38
BICORNGNI Alessandro ITA	13	BICORNGNI A. (ITA)	
LE DUC Tri CZE	14	LE DUC T. (CZE)	39
BELIK Vadim LTU		020 s0/ 000 s1 [02:00]	
WINTER Felix GER	15	WINTER F. (GER)	
NEYOLOV Denis CAN		002 s1/ 001 s1 [04:00]	
COHEN Itay ISR	16	COHEN I. (ISR)	40
		000 s0/ 001 s0 [05:07]	

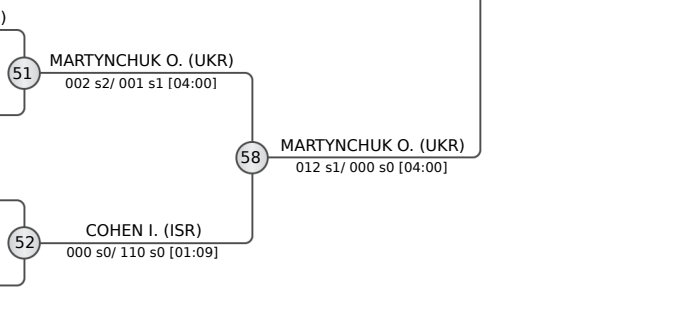

POOL C

CORMACK Angus AUS	17	CORMACK A. (AUS)	
PIO Leonardo ITA	18	PIO L. (ITA)	41
JAKUBAUSKAS Adris LTU	19	JAKUBAUSKAS A. (LTU)	
DVORAK Petr CZE		100 s0/ 000 s0 [02:01]	
SCHIER Francisco BRA	20	SCHIER F. (BRA)	42
MIDDLETON Vas AUS	21	MIDDLETON V. (AUS)	
NIKOLOV Preslav BUL	22	NIKOLOV P. (BUL)	43
LEE Jaejun KOR		001 s2/ 000 s1 [07:08]	
BREKKE-JENSSEN Torstein NOR	23	BREKKE-JENSSEN T. (NOR)	
LEHMEN Theodore USA	24	LEHMEN T. (USA)	44
		100 s1/ 000 s3 [09:26]	

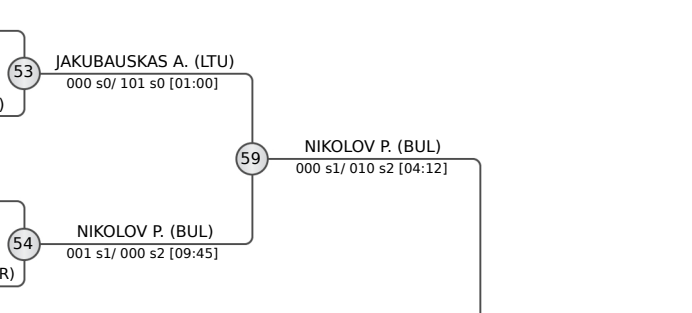

POOL D

POLIKEVICIUS Simas LTU	25	POLIKEVICIUS S. (LTU)	
PALILLO Thomas ITA	26	PALILLO T. (ITA)	45
ECHAVARRIA Omar USA	27	SIMSEK M. (TUR)	
SIMSEK Mustafa Berat TUR		000 s2/ 101 s1 [03:19]	
DEKAN Roman SVK	28	DEKAN R. (SVK)	46
MATI Anes CAN	29	MATI A. (CAN)	
ERCOLI Alessandro ITA	30	ERCOLI A. (ITA)	47
BIELAN Aristarkh UKR		001 s0/ 000 s2 [04:00]	
BAUD Romain SUI	31	BAUD R. (SUI)	
TAKHAEV Mukhamed GER	32	TAKHAEV M. (GER)	48
		001 s0/ 000 s1 [04:00]	

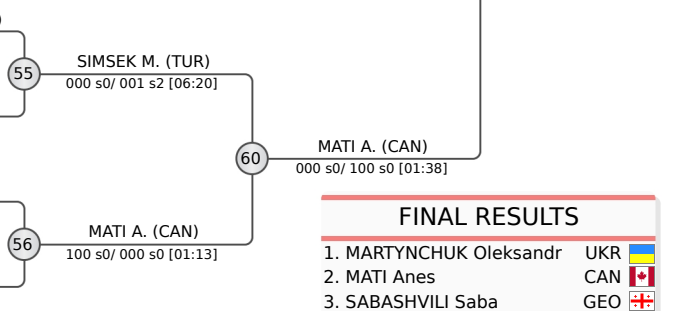

FINAL RESULTS		
1.	MARTYNCHUK Oleksandr	UKR
2.	MATI Anes	CAN
3.	SABASHVILI Saba	GEO
3.	SIMSEK Mustafa Berat	TUR
5.	NIKOLOV Preslav	BUL
5.	FIGUEIREDO Manuel	POR
7.	MIVOVAN Adrian	FRA
7.	JAKUBAUSKAS Adris	LTU

REPECHAGE

JACKEVICIUS R. (LTU)			
ESPOSITO A. (ITA)	61	ESPOSITO A. (ITA)	
		000 s2/ 020 s0 [01:51]	
		MUSAYEV M. (AZE)	65
		MUSAYEV M. (AZE)	65
GHIDONI T. (ITA)	62	GHIDONI T. (ITA)	
		001 s2/ 000 s0 [04:00]	
LEE J. (KOR)		MIVOVAN A. (FRA)	66
		MIVOVAN A. (FRA)	66
MIDDLETON V. (AUS)	63	LEE J. (KOR)	
		020 s0/ 000 s1 [03:44]	
		BREKKE-JENSSEN T. (NOR)	67
		BREKKE-JENSSEN T. (NOR)	67
ERCOLI A. (ITA)	64	ERCOLI A. (ITA)	
		BAUD R. (SUI)	68
		BAUD R. (SUI)	68
		010 s0/ 100 s0 [00:58]	

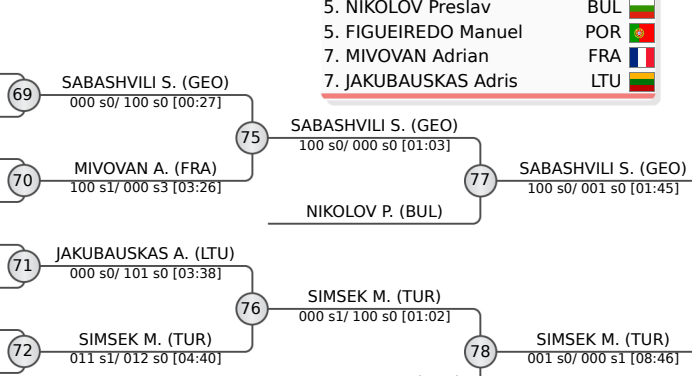



Prague Junior European Cup 2026

Czechia, Prague, 4-5 Jul 2026

-73 kg

Juniors (60)

POOL A

1	DOBRIČ Nikola (AUS)	2	PICCOLO G. (ITA)
3	MARYNYCH R. (UKR)	4	MOURA J. (BRA)
5	MAITIN S. (SUI)	6	PAVLOV P. (BUL)
7	BALESTRI E. (ITA)	8	RACKA N. (LTU)

POOL B

9	TAVOLETTA L. (ITA)	10	BULUK Y. (TUR)
11	KENZHALIYEV T. (KAZ)	12	TERNULLO D. (USA)
13	TERNULLO D. (USA)	14	DI LORENZO M. (ITA)
15	GIVISHVILI G. (GEO)	16	TSAPARAS K. (GRE)

POOL C

17	FITHANE F. (CAN)	18	BASTOS H. (BRA)
19	JOVSA D. (LTU)	20	JAFAROV M. (AZE)
21	ISKAKOV N. (KAZ)	22	KABRAN K. (FRA)
23	MELO V. (POR)	24	GANGL C. (AUT)

POOL D

25	BELL J. (AUS)	26	MIJIC M. (AUT)
27	DIMITROV I. (BUL)	28	PIDKIPNYY G. (UKR)
29	YUSUBOV A. (AZE)	30	KIM Y. (KOR)
31	RAKHIMZHANOV A. (KAZ)	32	TURGUTLU O. (TUR)

REPECHAGE

61	PAVLOV P. (BUL)	62	BULUK Y. (TUR)
63	PRYSHCHEPA A. (UKR)	64	KIM Y. (KOR)
65	BALESTRI E. (ITA)	66	BULUK Y. (TUR)
67	FITHANE F. (CAN)	68	TURGUTLU O. (TUR)

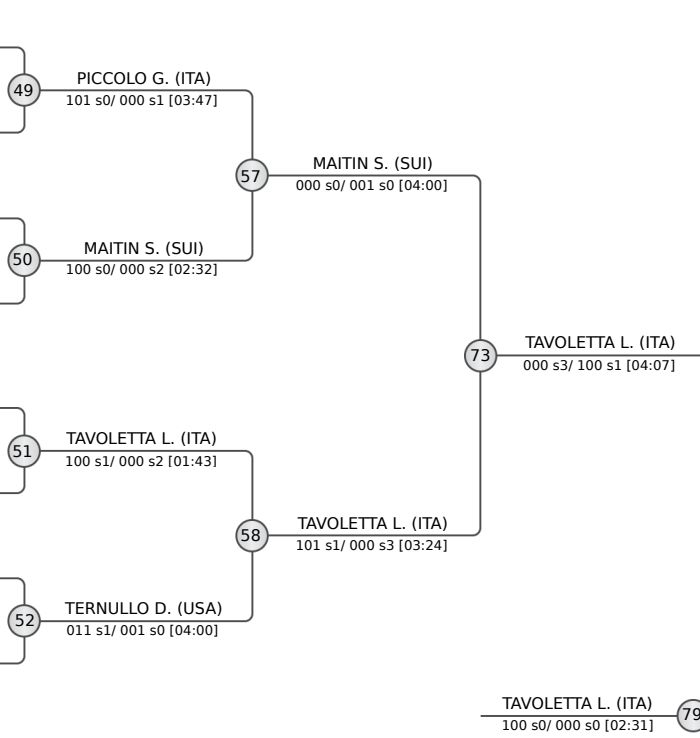

FINAL RESULTS		
1.	TAVOLETTA Lucio	ITA
2.	YUSUBOV Abil	AZE
3.	PICCOLO Gabriele	ITA
5.	JAFAROV Mehdi	AZE
5.	ISKAKOV Nursultan	KAZ
7.	BULUK Yusuf	TUR
7.	DIMITROV Ivo	BUL





Prague Junior European Cup 2026

Czechia, Prague, 4-5 Jul 2026

-81 kg

Juniors (54)

POOL A

1	NEYOLOV Artem	CAN
2	ZALAGH Redouane	FRA
3	ZITA Ondrej	CZE
4	MOCERINO Andrea	ITA
5	SIMUNIC Fran	CRO
6	SCHUMACHER Till	GER
7	RICHNER Suleyman	SUI
8	JAKHVELADZE Saba	GEO
9	VLACH Marek	CZE
10	DAVIES Peter	GBR
11	MANGIAPIA Daniel	ITA
12	PURPISŠ Nikass	LAT
13	KYDYRBAY Myrzatay	KAZ

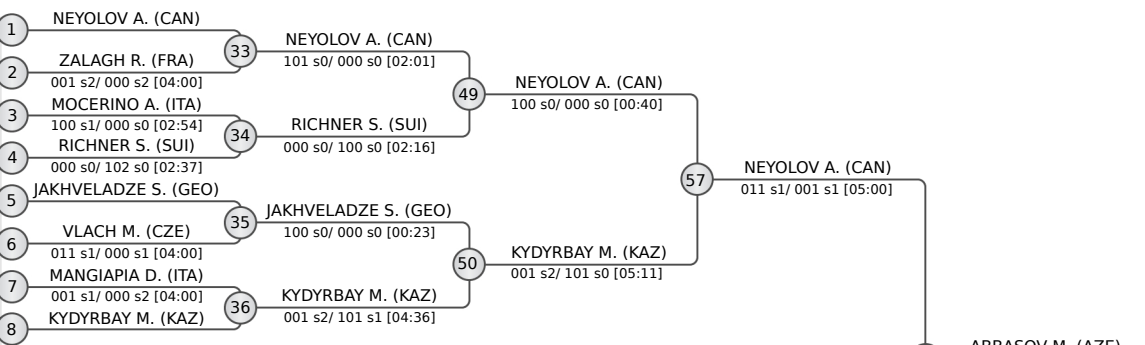

POOL B

9	SHULGIN Daniel	USA
10	VALCHEV Emil	BUL
11	NAPSO Aslan	ISR
12	TYBURN Elliott	FRA
13	VAVRA Matyas	CZE
14	DJURISIC Balsa	MNE
15	ABBASOV Mehdi	AZE
16	DE OLIVEIRA Octavio	USA
17	VAKHTANGADZE Tornike	GEO
18	BRUECKNER Hannes	GER
19	HAJNECKY Marco	SVK
20	ZADNIPRIANETS Ivan	UKR
21	JICINSKY Radim	CZE
22	D URBANO Alessandro Bruno	ITA

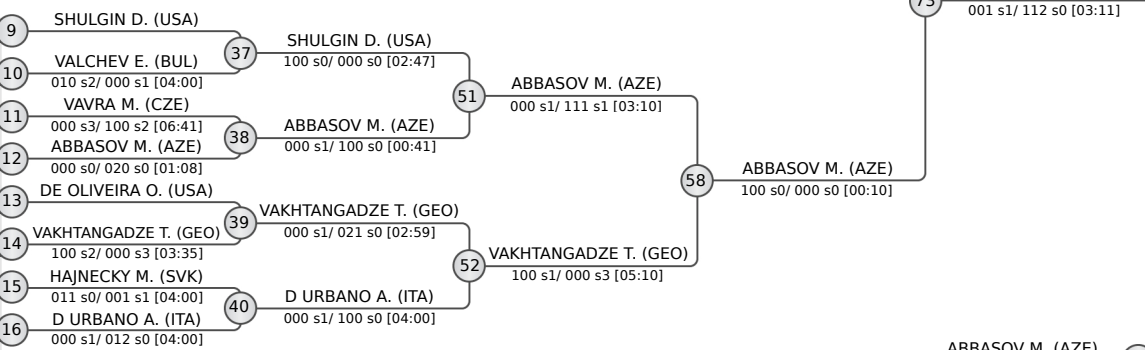

POOL C

17	JOHNSTON Kyle	AUS
18	ZAK Adam	CZE
19	GUDEJEVS Arsenijs	LAT
20	MIHALEV Nikolaz	BUL
21	HAMDAOUI Ahmed-Adam	FRA
22	ROEDER Henry	GER
23	KUNDUKHASHVILI Shota	USA
24	NURBERGENOV Omar	KAZ
25	IBADLI Jasur	AZE
26	IOANNOU Markelos	CYP
27	SARBOCH Adam	CZE
28	ISDAHL Thomas Eriksen	NOR
29	RUSSO Edoardo Michele	ITA

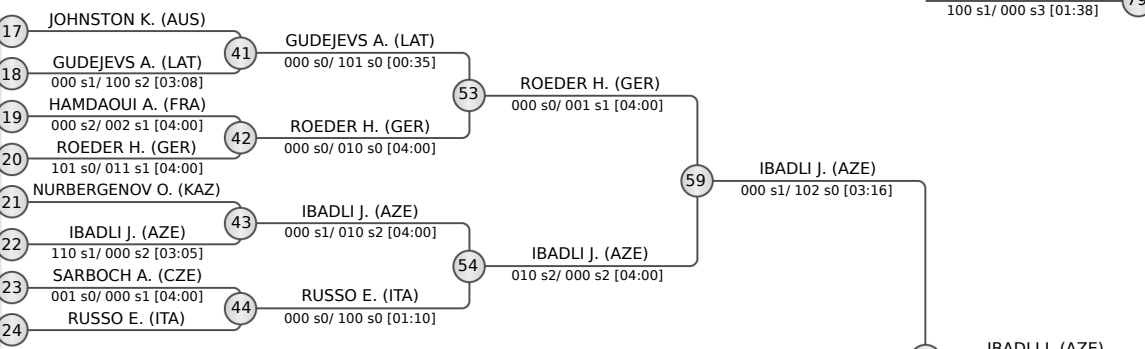

POOL D

25	COSTA Silas	BRA
26	KIBIZOV Sarmat	CAN
27	GARAYEV Roman	AZE
28	GRABNER Erik	AUT
29	CIGNINI Luca	ITA
30	HAVRANEK Josip	CRO
31	MILLER Evan	USA
32	NIELZIEV Taras	UKR
33	RAK Maxmilian	CZE
34	KOCZINSKI Arel	ISR
35	SIMIN Milan	SRB
36	KURDGELASHVILI Nikoloz	GEO
37	BULATOVIC Filip	MNE
38	MAZZOLA Salvatore	ITA

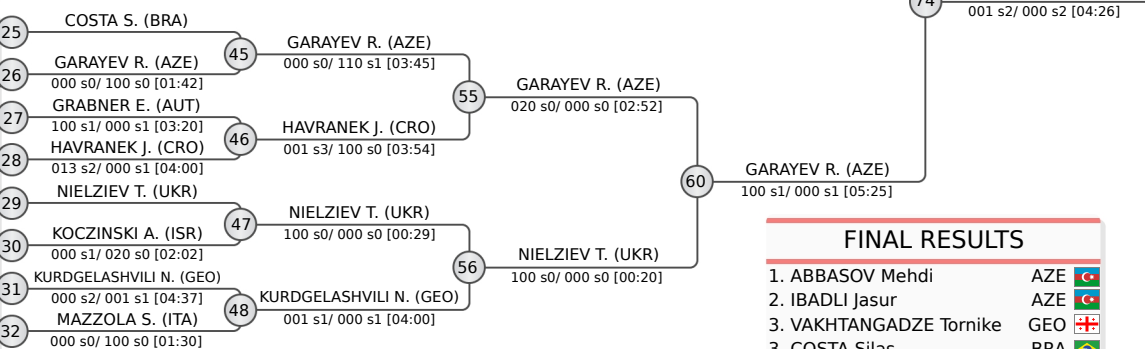

FINAL RESULTS		
1.	ABBASOV Mehdi	AZE
2.	IBADLI Jasur	AZE
3.	VAKHTANGADZE Tornike	GEO
3.	COSTA Silas	BRA
5.	GARAYEV Roman	AZE
5.	NEYOLOV Artem	CAN
7.	RICHNER Suleyman	SUI
7.	ROEDER Henry	GER

REPECHAGE

61	ZALAGH R. (FRA)
62	DJURISIC B. (MNE)
63	NURBERGENOV O. (KAZ)
64	COSTA S. (BRA)

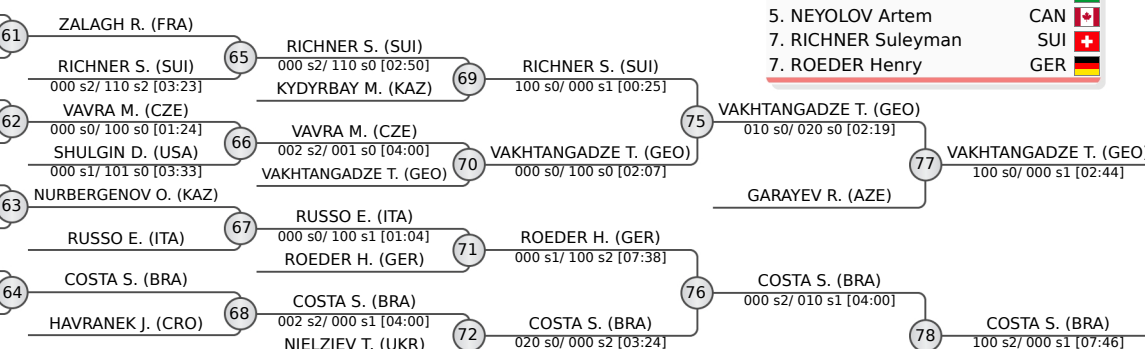



Prague Junior European Cup 2026

Czechia, Prague, 4-5 Jul 2026

-90 kg

Juniors (41)

POOL A

1	MOLCHANOV Matthew (CAN)	1	MOLCHANOV M. (CAN)
2	VALKOVIC Ronald (SVK)	2	VALKOVIC R. (SVK)
3	MAROUSEK Alex (CZE)	3	KHOROSHAILOV M. (UKR)
4	KHOROSHAILOV Mykhailo (UKR)	4	CARTA A. (ITA)
5	CARTA Alex (ITA)	5	MANFELDS Tomass (LAT)
6	MANFELDS Tomass (LAT)	6	BOZIC M. (CRO)
7	SARBOCH Vit (CZE)	7	BOZIC Marko (CRO)
8	ALLAHVERDIYEV Murad (AZE)	8	ALLAHVERDIYEV M. (AZE)
	GVELESIANI Saba (GEO)		GUSIC I. (BIH)
	GUSIC Imran (BIH)		GUSIC I. (BIH)

POOL B

9	MINCINESI Cristiano (ITA)	9	MINCINESI C. (ITA)
10	PEREVERTAILO Kyrylo (UKR)	10	PEREVERTAILO K. (UKR)
11	MEDAN Nikola (SRB)	11	GAZIMAMMADOV A. (AZE)
12	GAZIMAMMADOV Ali (AZE)	12	SEBELKA H. (CZE)
13	SEBELKA Hugo (CZE)	13	ZADVINSKIY Nicholas (USA)
14	ZADVINSKIY Nicholas (USA)	14	KOREGEN D. (KAZ)
15	SIDLOVSKIY Mikhailo (POL)	15	SIDLOVSKIY M. (POL)
16	KUCERA Kristian (CZE)	16	DIMITROV A. (BUL)
	DIMITROV Anton (BUL)		DIMITROV A. (BUL)

POOL C

17	CANELLO Joao Pedro (BRA)	17	CANELLO J. (BRA)
18	BURKO Alon (ISR)	18	BILOUS I. (UKR)
19	BILOUS Illia (UKR)	19	KLIMES V. (CZE)
20	KLIMES Vojtech (CZE)	20	MORENA M. (ITA)
21	MORENA Manuele (ITA)	21	TEVDORADZE Luka (GEO)
22	TEVDORADZE Luka (GEO)	22	SIMAN Florian (CZE)
23	SIMAN Florian (CZE)	23	OBRADOVIC Nikola (SRB)
24	OBRADOVIC Nikola (SRB)	24	PETROVSKIY Taras (USA)
	PETROVSKIY Taras (USA)		ENZ Lorenzo (SUI)
	ENZ Lorenzo (SUI)		ENZ Lorenzo (SUI)

POOL D

25	SOKYRKO Serhii (UKR)	25	SOKYRKO S. (UKR)
26	ANTUNES Victor (POR)	26	ANTUNES V. (POR)
27	ROSSI Mattia (ITA)	27	LIPARTELIANI D. (GEO)
28	LIPARTELIANI Dachi (GEO)	28	VARTYR M. (CZE)
29	VARTYR Matej (CZE)	29	SHUKUROV Suleyman (AZE)
30	SHUKUROV Suleyman (AZE)	30	VASUT Ondrej (CZE)
31	VASUT Ondrej (CZE)	31	BRNADA I. (CRO)
32	BRNADA I. (CRO)	32	JEON Minseok (KOR)
	JEON Minseok (KOR)		JACENKO Arturs (LAT)
	JACENKO Arturs (LAT)		JACENKO A. (LAT)

REPECHAGE

61	BOZIC M. (CRO)	61	BOZIC M. (CRO)
62	PEREVERTAILO K. (UKR)	62	PEREVERTAILO K. (UKR)
63	SIMAN F. (CZE)	63	SIMAN F. (CZE)
64	ANTUNES V. (POR)	64	ANTUNES V. (POR)
65	GUSIC I. (BIH)	65	GUSIC I. (BIH)
66	GAZIMAMMADOV A. (AZE)	66	GAZIMAMMADOV A. (AZE)
67	ENZ L. (SUI)	67	ENZ L. (SUI)
68	VARTYR M. (CZE)	68	VARTYR M. (CZE)
69	GUSIC I. (BIH)	69	GUSIC I. (BIH)
70	GAZIMAMMADOV A. (AZE)	70	GAZIMAMMADOV A. (AZE)
71	KLIMES V. (CZE)	71	KLIMES V. (CZE)
72	SHUKUROV S. (AZE)	72	SHUKUROV S. (AZE)
73	MINCINESI C. (ITA)	73	MINCINESI C. (ITA)
74	TEVDORADZE L. (GEO)	74	TEVDORADZE L. (GEO)
75	GAZIMAMMADOV A. (AZE)	75	GAZIMAMMADOV A. (AZE)
76	SHUKUROV S. (AZE)	76	SHUKUROV S. (AZE)
77	SOKYRKO S. (UKR)	77	SOKYRKO S. (UKR)
78	SHUKUROV S. (AZE)	78	SHUKUROV S. (AZE)

FINAL RESULTS		
1.	MINCINESI Cristiano	ITA
2.	TEVDORADZE Luka	GEO
3.	SOKYRKO Serhii	UKR
3.	SHUKUROV Suleyman	AZE
5.	GAZIMAMMADOV Ali	AZE
5.	MANFELDS Tomass	LAT
7.	GUSIC Imran	BIH
7.	ENZ Lorenzo	SUI





Prague Junior European Cup 2026

Czechia, Prague, 4-5 Jul 2026

-100 kg

Juniors (31)

POOL A

	LIUBIMOVSKI Daniel	USA
	FIORE Francesco	ITA
	BOISSONNET Hugo	FRA
	ZAALISHVILI Nikoloz	GEO
	BISCHOFF Samuel	GER
	JERABEK Martin	CZE
	YAKYMENKO Illia	UKR

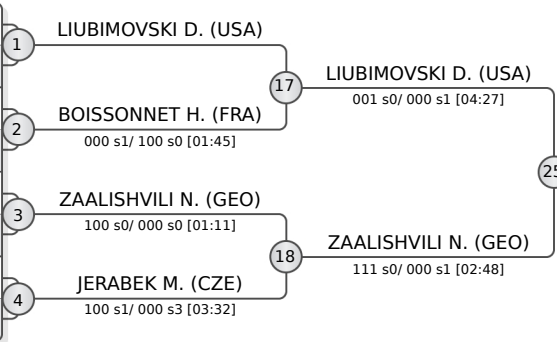

POOL B

	KIM Kyungmin	KOR
	ZIADI Yosef	ISR
	KOPRIVICA Jovan	SRB
	PENONE Yuri	ITA
	MAZZON Francesco	ITA
	RISUKHIN Bohdan	UKR
	ALIYEV Janpolad	AZE
	CALDER Jaden	GBR

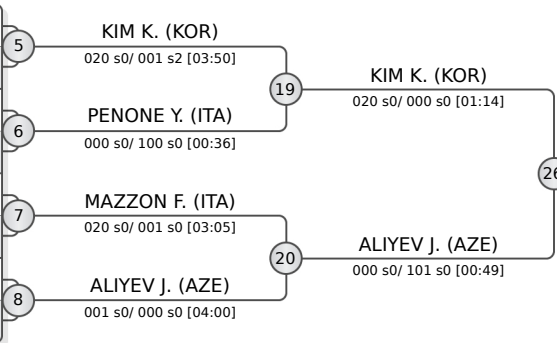

POOL C

	HADDAD Caedmon	USA
	VANEK Michal	CZE
	MAKARENKO Artur	UKR
	TATARU Gheorghe	GBR
	GELASHVILI Giorgi	GEO
	STOROZHUK Danilo	POR
	CAPPELLO Giorgio	ITA
	MOUSSIMA EWANE ELOUTI Franck David	CAN

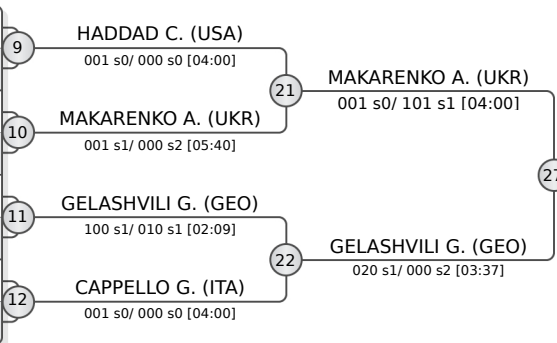

POOL D

	GENYS Majus	LTU
	AFANASJEVS Nikita	LAT
	SHYSHOV Mykhailo	UKR
	UZAN Amit Amos	ISR
	NAMAZLI Davud	AZE
	PAPUKISHVILI David	GEO
	BULATOVIC Pavle	MNE
	ARMANO Filippo	ITA

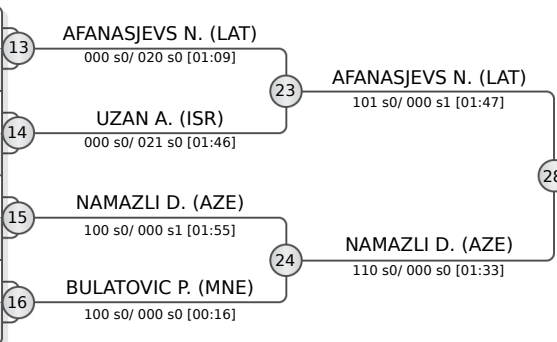

REPECHAGE

BISCHOFF S. (GER)	29 BISCHOFF S. (GER) 100 s0/ 000 s1 [03:59]	33 LIUBIMOVSKI D. (USA) 000 s1/ 010 s0 [04:00]
JERABEK M. (CZE)	30 MAZZON F. (ITA) 012 s0/ 100 s0 [02:57]	34 MAZZON F. (ITA) 100 s0/ 000 s0 [01:07]
CALDER J. (GBR)	31 STOROZHUK D. (POR) 001 s1/ 000 s1 [04:00]	35 MAKARENKO A. (UKR) 000 s0/ 100 s1 [01:41]
MAZZON F. (ITA)	32 PAPUKISHVILI D. (GEO) 101 s0/ 000 s1 [03:14]	36 PAPUKISHVILI D. (GEO) 020 s0/ 000 s0 [03:20]
STOROZHUK D. (POR)		
CAPPELLO G. (ITA)		
PAPUKISHVILI D. (GEO)		
BULATOVIC P. (MNE)		

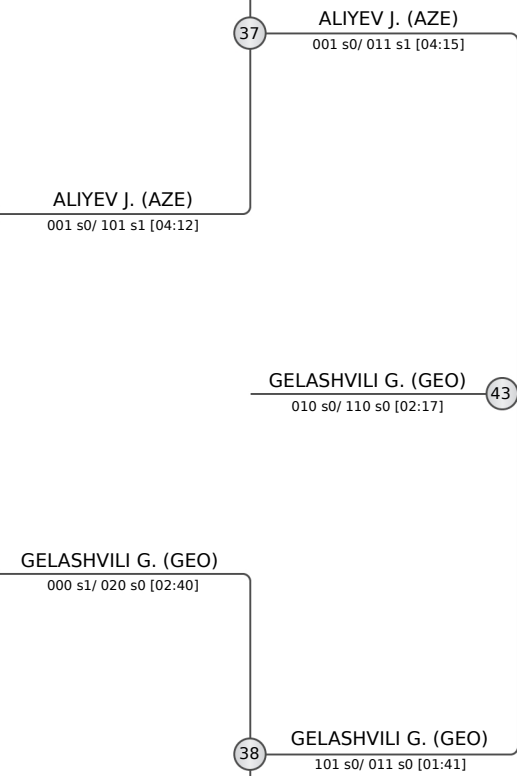
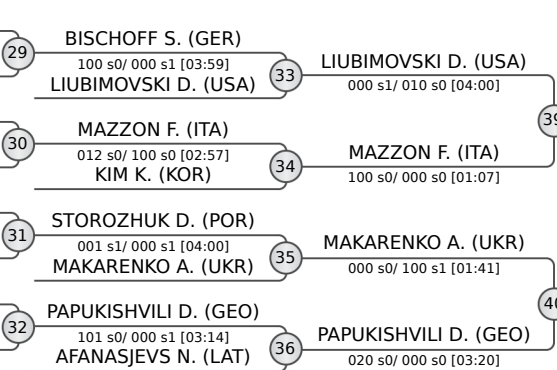

FINAL RESULTS		
1.	GELASHVILI Giorgi	GEO
2.	ALIYEV Janpolad	AZE
3.	NAMAZLI Davud	AZE
3.	ZAALISHVILI Nikoloz	GEO
5.	MAZZON Francesco	ITA
5.	PAPUKISHVILI David	GEO
7.	LIUBIMOVSKI Daniel	USA
7.	MAKARENKO Artur	UKR





Prague Junior European Cup 2026

Czechia, Prague, 4-5 Jul 2026

+100 kg

Juniors (20)

POOL A

	AHMADOV Ramazan	AZE	1	AHMADOV R. (AZE)
	ALBANO II Alexandre	BRA	2	ALBANO II A. (BRA)
	CESARINI Francesco	ITA		101 s0/ 000 s0 [00:38]
	MADEN Mahmutcan	TUR	3	MADEN M. (TUR)
	KOBALADZE Nodar	GEO	4	KOBALADZE N. (GEO)

POOL B

	KIM Minjun	KOR	5	KIM M. (KOR)
	DAMM Felix	GER	6	DAMM F. (GER)
	FESENKO Oleh	UKR	7	FESENKO O. (UKR)
	SCHARNER Oliver	AUT	8	SCHARNER O. (AUT)
	TRUHLAR Martin	CZE		011 s1/ 000 s0 [04:00]

POOL C

	OMELCHENKO Yaroslav	UKR	9	OMELCHENKO Y. (UKR)
	MARKOV Nikola	BUL	10	MARKOV N. (BUL)
	ENDELADZE Uta	ITA		110 s0/ 000 s3 [03:49]
	SEDLAK Martin	CZE	11	SEDLAK M. (CZE)
	KOVINIC Stefan	MNE	12	KOVINIC S. (MNE)

POOL D

	SULTAN Beibarys	KAZ	13	SULTAN B. (KAZ)
	KOSTELIDIS Ioannis	GRE	14	KOSTELIDIS I. (GRE)
	SCHINDLER Lasse Tjark	GER		020 s0/ 000 s0 [00:56]
	KARCHAIDZE Giorgi	GEO	15	KARCHAIDZE G. (GEO)
	CORSICA Michele	ITA	16	CORSICA M. (ITA)

REPECHAGE

29	ALBANO II A. (BRA)	33	MADEN M. (TUR)
30	DAMM F. (GER)	34	FESENKO O. (UKR)
31	MARKOV N. (BUL)	35	MARKOV N. (BUL)
32	KOSTELIDIS I. (GRE)	36	KARCHAIDZE G. (GEO)

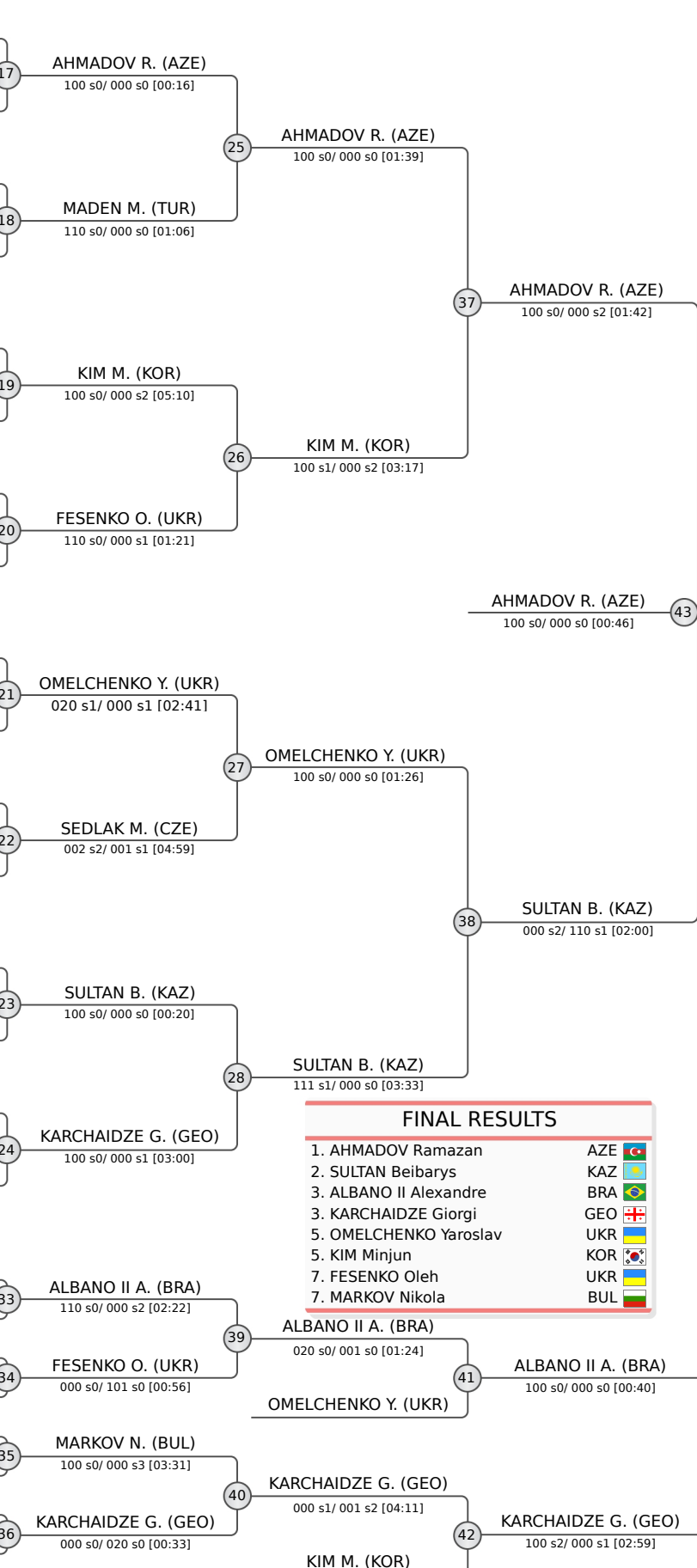

FINAL RESULTS		
1.	AHMADOV Ramazan	AZE
2.	SULTAN Beibarys	KAZ
3.	ALBANO II Alexandre	BRA
3.	KARCHAIDZE Giorgi	GEO
5.	OMELCHENKO Yaroslav	UKR
5.	KIM Minjun	KOR
7.	FESENKO Oleh	UKR
7.	MARKOV Nikola	BUL





Prague Junior European Cup 2026

Czechia, Prague, 4-5 Jul 2026

-48 kg

Juniors (20)

POOL A

	MENDES Sarah	BRA
	BROVOLD Selma	NOR
	LISOHOROVA Alona	UKR
	CESANA Chiara	ITA
	VEILLARD Melody	SUI

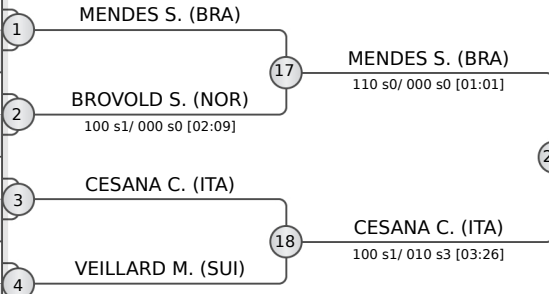

POOL B

	EWING Eva	GBR
	LEE Yoojin	KOR
	WAKABAYASHI Miyu	JPN
	AUER Nina	AUT
	PISATURO Giulia	ITA

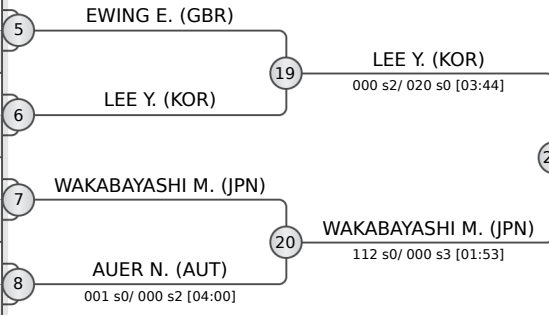

POOL C

	RANGELOVA Sofia	BUL
	MAYRHOFER Lena	AUT
	ERB Alexandra	USA
	PEREIRA Mariana	POR
	AUREL Mathilde	FRA

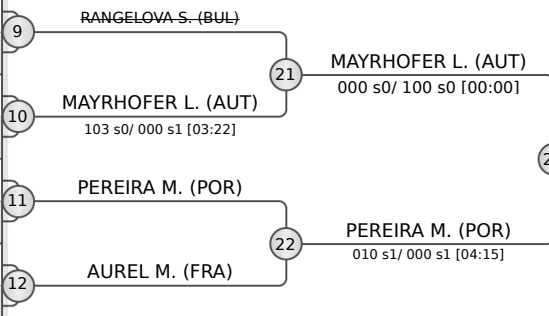

POOL D

	PETRENKO Liliia	UKR
	AHMADOVA Nargiz	AZE
	KUTENKOVA Mariia	UKR
	ZEDDA Roberta	ITA
	HIROSE Rio	AUS

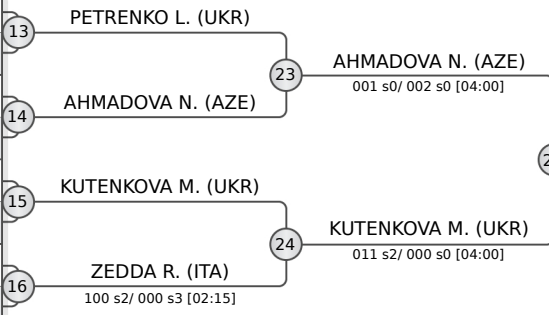

FINAL RESULTS	
1. MENDES Sarah	BRA
2. AHMADOVA Nargiz	AZE
3. WAKABAYASHI Miyu	JPN
3. LEE Yoojin	KOR
5. MAYRHOFER Lena	AUT
5. PEREIRA Mariana	POR
7. CESANA Chiara	ITA
7. PETRENKO Liliia	UKR

REPECHAGE

29	BROVOLD S. (NOR)
30	EWING E. (GBR)
31	RANGELOVA S. (BUL)
32	PETRENKO L. (UKR)
33	CESANA C. (ITA)
34	WAKABAYASHI M. (JPN)
35	PEREIRA M. (POR)
36	PETRENKO L. (UKR)

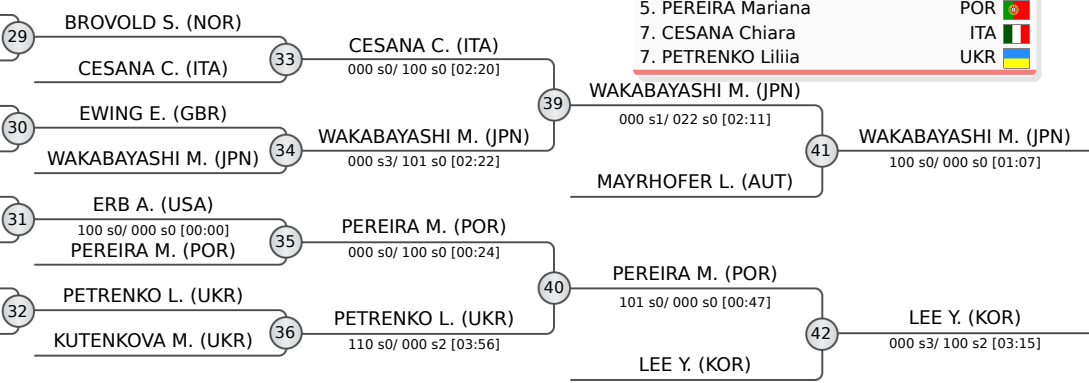



Prague Junior European Cup 2026

Czechia, Prague, 4-5 Jul 2026

-52 kg

Juniors (24)

POOL A

	MARQUES Nicole	BRA
	CIALINI Beatrice	ITA
	HODGKINSON Daisy	GBR
	TORO Asia	ITA
	MIRZAYEVA Farida	AZE
	BAEK Jiho	KOR

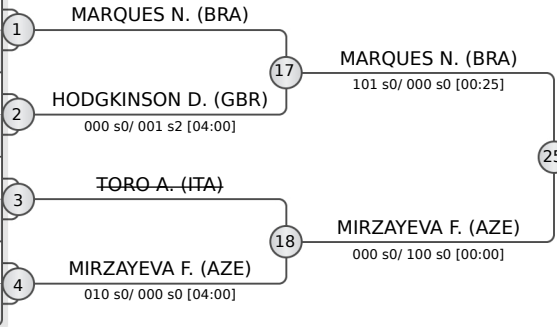

POOL B

	MIROSHNICHENKO Marharyta	UKR
	AGUMAVA Roza	GER
	TAMURA Addyson	CAN
	HRECHKA Sofia	UKR
	NIUTTA Sofia	ITA
	MANIBOG Malia	USA

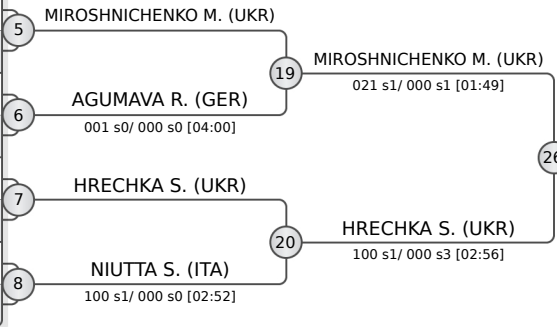

POOL C

	BOURIHANE Rima	CAN
	NETTESHEIM Charlotte	GER
	BONZANO Giulia	ITA
	ALDER Amelia	GBR
	AIROLA GRANACI Iulia	ITA
	FOURNIAT Elodie	FRA

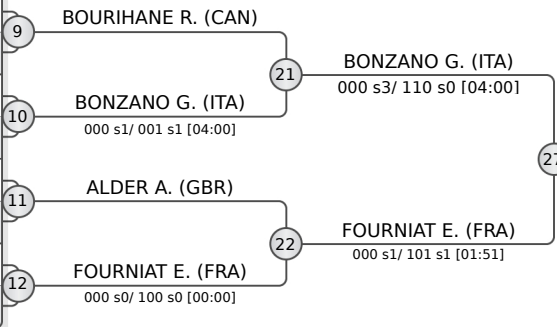

POOL D

	BERSELLINI Alice	ITA
	HAJIZADA Nurana	AZE
	CHERNUKHA Veronika	UKR
	MCPHERSON Mackenzie	USA
	TWAROWSKA Barbara	POL
	SERAFINI India	ITA

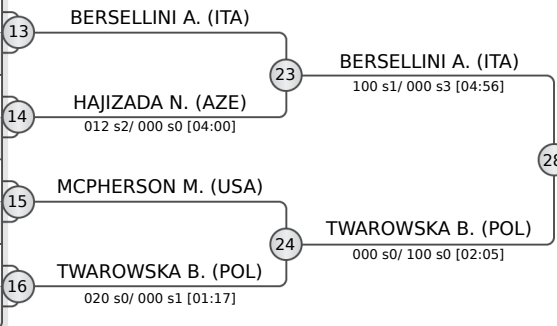

FINAL RESULTS	
1.	TWAROWSKA Barbara POL
2.	MARQUES Nicole BRA
3.	AGUMAVA Roza GER
3.	SERAFINI India ITA
5.	BONZANO Giulia ITA
5.	MIROSHNICHENKO Marharyta UKR
7.	MIRZAYEVA Farida AZE
7.	FOURNIAT Elodie FRA

REPECHAGE

HODGKINSON D. (GBR)	29	HODGKINSON D. (GBR)
AGUMAVA R. (GER)	30	AGUMAVA R. (GER)
NETTESHEIM C. (GER)	31	BOURIHANE R. (CAN)
BOURIHANE R. (CAN)	31	BOURIHANE R. (CAN)
SERAFINI I. (ITA)	32	SERAFINI I. (ITA)
MCPHERSON M. (USA)	32	MCPHERSON M. (USA)

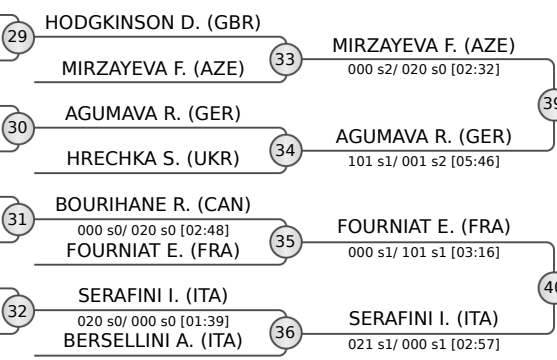



Prague Junior European Cup 2026

Czechia, Prague, 4-5 Jul 2026

-57 kg

Juniors (30)

POOL A

	GAGNON Laurence	CAN
	MASTROPIETRO Ludovica	ITA
	CLARK Elsa	USA
	KORCAKOVA Marketa	CZE
	SEMOUD Luna	GER
	TUCAJ Martina	CRO
	VERDIYEVA Aytan	AZE

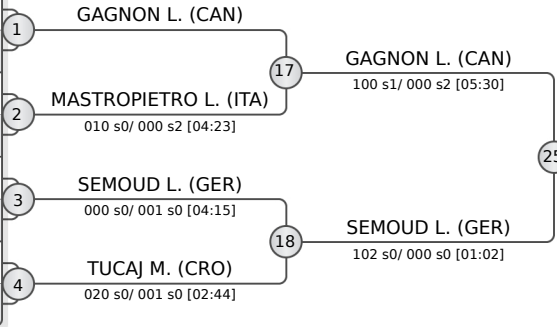

POOL B

	MENEZES Larissa	BRA
	KISSENISKY Maddy	GBR
	SEVERYN Anastasiia	UKR
	HAJIYEVA Vusala	AZE
	SORELLI Giulia	ITA
	MANAILA Nicole Daria	CAN
	BELLEVAL Jaines	FRA
	POSPISILOVA Adela	CZE

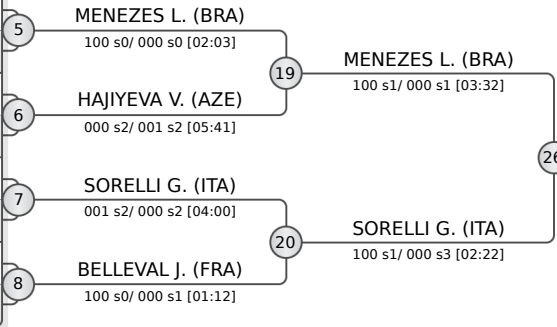

POOL C

	KUCHAR Varvara	LTU
	HILLER Harlee	USA
	HERMANOVA Karolina	CZE
	MARTELLACCI Alice	ITA
	GADASHOVA Khadzizha	AZE
	GRENIER Melody	CAN
	ZUEND Annika	SUI

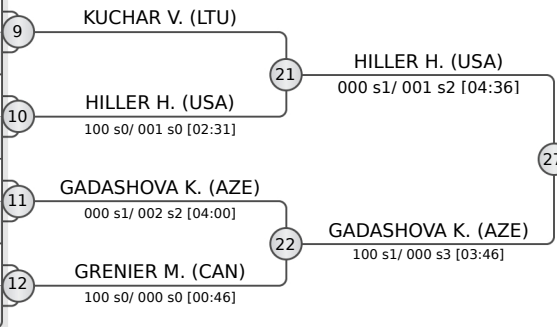

POOL D

	KELLY Oren	AUS
	HADAR Noa	ISR
	FRADE Victoria	BRA
	MOMOT Neonila	UKR
	AZINOEU Marina	CYP
	KOSTROVETS Valeria	CAN
	MERTLOVA Andrea	CZE
	STORIONE Elena	ITA

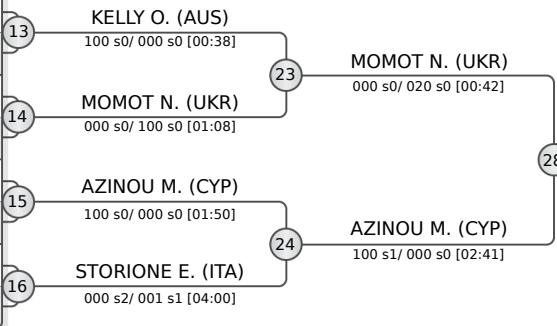

REPECHAGE

KORCAKOVA M. (CZE)	29	KORCAKOVA M. (CZE)	33
TUCAJ M. (CRO)		GAGNON L. (CAN)	
KISSENISKY M. (GBR)	30	KISSENISKY M. (GBR)	34
HAJIYEVA V. (AZE)		SORELLI G. (ITA)	
MARTELLACCI A. (ITA)	31	MARTELLACCI A. (ITA)	35
GRENIER M. (CAN)		HILLER H. (USA)	
FRADE V. (BRA)	32	FRADE V. (BRA)	36
KELLY O. (AUS)		AZINOEU M. (CYP)	

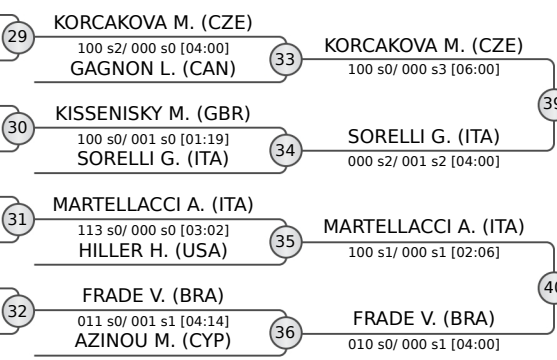

FINAL RESULTS	
1. MOMOT Neonila	UKR
2. SEMOUD Luna	GER
3. GADASHOVA Khadzizha	AZE
3. MARTELLACCI Alice	ITA
5. SORELLI Giulia	ITA
5. MENEZES Larissa	BRA
7. KORCAKOVA Marketa	CZE
7. FRADE Victoria	BRA





Prague Junior European Cup 2026

Czechia, Prague, 4-5 Jul 2026

-63 kg

Juniors (37)

POOL A

1	TANDEAN Bianca (AUS)	33	THOMSON M. (CAN)
2	THOMSON Maia (CAN)	34	MORUZZI R. (ITA)
3	FONSECA L. (BRA)	35	FROSONI G. (ITA)
4	FONSECA Laryssa (BRA)	36	YANG J. (KOR)
5	MORUZZI Rachele (ITA)	37	JASPE E. (USA)
6	FROSONI Giorgia (ITA)	38	RZAYEVA N. (AZE)
7	MUELLER K. (GER)	39	ROTTENHOFER H. (AUT)
8	CECHOVA Veronika (CZE)	40	MATUSZEKOVA P. (SVK)
	KABA Kadidja (FRA)	41	VAN ZYL C. (CAN)
	YANG Jieon (KOR)	42	SISKOVA S. (CZE)

POOL B

9	JASPE Emily Daniela (USA)	43	PAGLIARO M. (ITA)
10	COMBA Anita (ITA)	44	VUKADINOVIC D. (SRB)
11	ALEMPS Zoe (FRA)	45	MAIA M. (BRA)
12	ZHAISSANGBAY Zhibek (KAZ)	46	ZAMBON R. (ITA)
13	RZAYEVA Nilgun (AZE)	47	ABBOTT E. (USA)
14	ROTTENHOFER Helena (AUT)	48	BOICHENKO D. (UKR)
15	GAMBARDELLA Nina (ITA)	49	ORIMO Toa (JPN)
16	MATUSZEKOVA Paula (SVK)	50	JURKUTAT Laura (GER)
	VONDRAKOVA Lada (CZE)	51	CAVAGLIA Marika (ITA)
		52	BOLTVANOVA Lea (SVK)

POOL C

17	VAN ZYL Carla (CAN)	53	ROTTENHOFER H. (AUT)
18	BLOCHE Manon (FRA)	54	PAGLIARO M. (ITA)
19	SISKOVA Stela (CZE)	55	MAIA M. (BRA)
20	CARDELLA Sara (ITA)	56	ZAMBON R. (ITA)
21	SILVEIRA Maria (POR)	57	ABBOTT E. (USA)
22	PAGLIARO Maila (ITA)	58	BOICHENKO D. (UKR)
23	VUKADINOVIC Djurdja (SRB)	59	ORIMO Toa (JPN)
24	BACHLER Anna (AUT)	60	JURKUTAT Laura (GER)
	DRDAKOVA Martina (SVK)	61	CAVAGLIA Marika (ITA)
		62	BOLTVANOVA Lea (SVK)

POOL D

25	MAIA Manuela (BRA)	63	ROTTENHOFER H. (AUT)
26	PELCLOVA Kristyna (CZE)	64	PAGLIARO M. (ITA)
27	ZAMBON Reika (ITA)	65	MAIA M. (BRA)
28	ABBOTT Ellianna (USA)	66	ZAMBON R. (ITA)
29	BOICHENKO Daria (UKR)	67	ABBOTT E. (USA)
30	ORIMO Toa (JPN)	68	BOICHENKO D. (UKR)
31	JURKUTAT Laura (GER)	69	ORIMO Toa (JPN)
32	CAVAGLIA Marika (ITA)	70	JURKUTAT Laura (GER)
	BOLTVANOVA Lea (SVK)	71	CAVAGLIA Marika (ITA)
		72	BOLTVANOVA Lea (SVK)

REPECHAGE

61	MUELLER K. (GER)	65	YANG J. (KOR)
62	GAMBARDELLA N. (ITA)	66	THOMSON M. (CAN)
63	BLOCHE M. (FRA)	67	JASPE E. (USA)
64	BOICHENKO D. (UKR)	68	JASPE E. (USA)
		69	YANG J. (KOR)
		70	JASPE E. (USA)
		71	PAGLIARO M. (ITA)
		72	MAIA M. (BRA)
		73	FROSONI G. (ITA)
		74	ORIMO T. (JPN)
		75	JASPE E. (USA)
		76	MAIA M. (BRA)
		77	VAN ZYL C. (CAN)
		78	MAIA M. (BRA)
		79	ORIMO T. (JPN)

FINAL RESULTS

- ORIMO Toa (JPN)
- FROSONI Giorgia (ITA)
- VAN ZYL Carla (CAN)
- MAIA Manuela (BRA)
- JASPE Emily Daniela (USA)
- ROTTENHOFER Helena (AUT)
- YANG Jieon (KOR)
- PAGLIARO Maila (ITA)





Prague Junior European Cup 2026

Czechia, Prague, 4-5 Jul 2026

-70 kg

Juniors (27)

POOL A

	THIBAUT Charlie	CAN
	MO Sumin	KOR
	COUTO HOTTIS Maria Julia	ITA
	NAVICKAITE Marta	LTU
	MOREIRA Ana Beatriz	BRA
	WINTER Leya	GER
	NEMCOVA Barbora	CZE

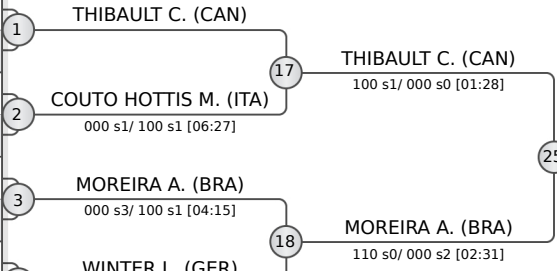

POOL B

	DORVAL MBELE Missy Jen	CAN
	JURCIKOVA Viktorie	CZE
	DIALLO Malika	FRA
	CAMARA Sophia	BRA
	GRASSI Giorgia	ITA
	OMACKOVA Amalie	CZE

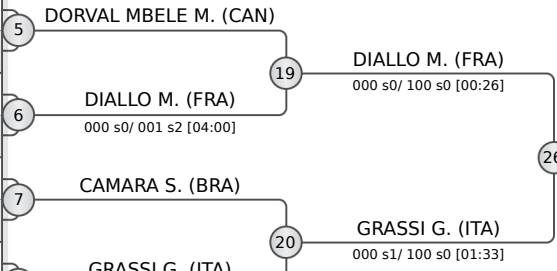

POOL C

	VALLIM Clarisse	BRA
	ESPOSITO Alessia	ITA
	SEDIVA Adela	CZE
	VIRGILIO Sara	ITA
	SCHLIEPER Carlotta	GER
	MORINO Chiharu	JPN
	SPERLING Anna Julia	BRA

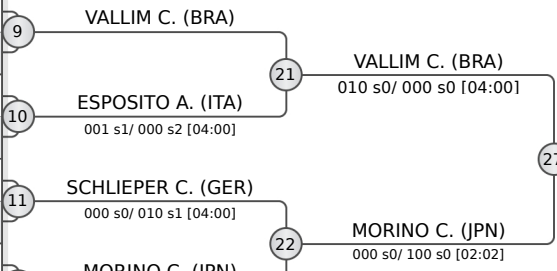

POOL D

	JAAFAR Nadie	BUL
	PONOMARJOVA Sofija	LAT
	KUCEROVA Anna	CZE
	VOZNIUK Liudmyla	UKR
	CAPUANO Irene	ITA
	GRAMBO Anna	NOR
	GIACHINI Mariana	BRA

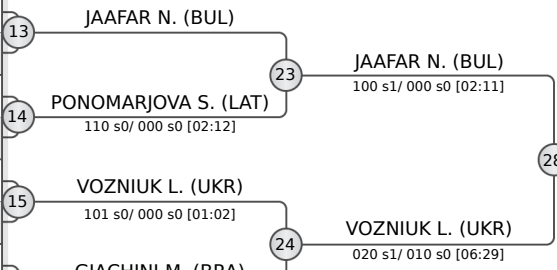

REPECHAGE

29	COUTO HOTTIS M. (ITA)	33	COUTO HOTTIS M. (ITA)
30	OMACKOVA A. (CZE)	34	CAMARA S. (BRA)
31	SCHLIEPER C. (GER)	35	VALLIM C. (BRA)
32	GIACHINI M. (BRA)	36	JAAFAR N. (BUL)

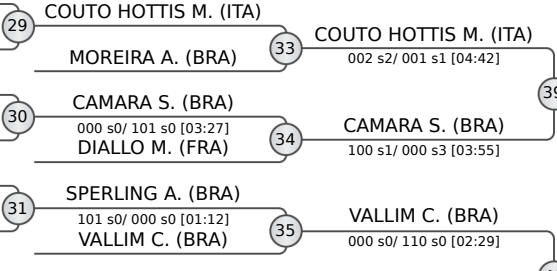

FINAL RESULTS

- VOZNIUK Liudmyla
- GRASSI Giorgia
- MORINO Chiharu
- VALLIM Clarisse
- CAMARA Sophia
- THIBAUT Charlie
- COUTO HOTTIS Maria Julia
- JAAFAR Nadie





Prague Junior European Cup 2026

Czechia, Prague, 4-5 Jul 2026

-78 kg

Juniors (14)

POOL A

	KLINGER Johanna Elisabeth	BIH
	MENANTEAU Jeanne	FRA
	KIM Goeun	KOR

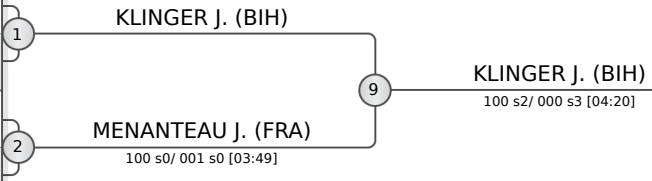

POOL B

	MAGLI Lucia	ITA
	TITOVETS Kira	UKR
	MANUKYAN Mia	GER
	KATSUMATA Misuzu	JPN

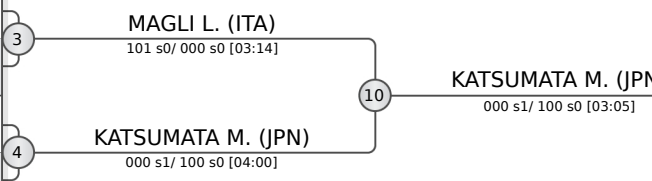

POOL C

	KOSNAROVA Marie	CZE
	JOHANNESSEN Eva	NOR
	TKACHOVA Anna	UKR

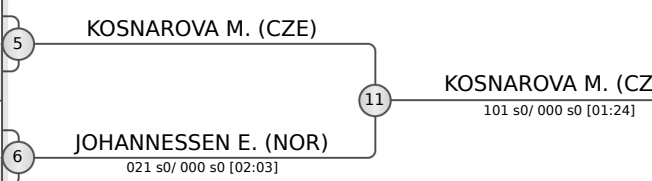

POOL D

	AKHMETOVA Saltanat	KAZ
	OTAWA Kokoro	JPN
	YERGALI Tomiris	KAZ
	BESKER Ana	CRO

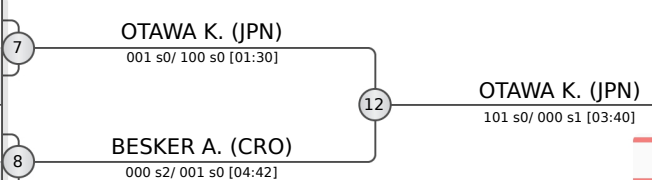

REPECHAGE

MENANTEAU J. (FRA)	13
MANUKYAN M. (GER)	
MAGLI L. (ITA)	14
JOHANNESSEN E. (NOR)	15
AKHMETOVA S. (KAZ)	
BESKER A. (CRO)	16

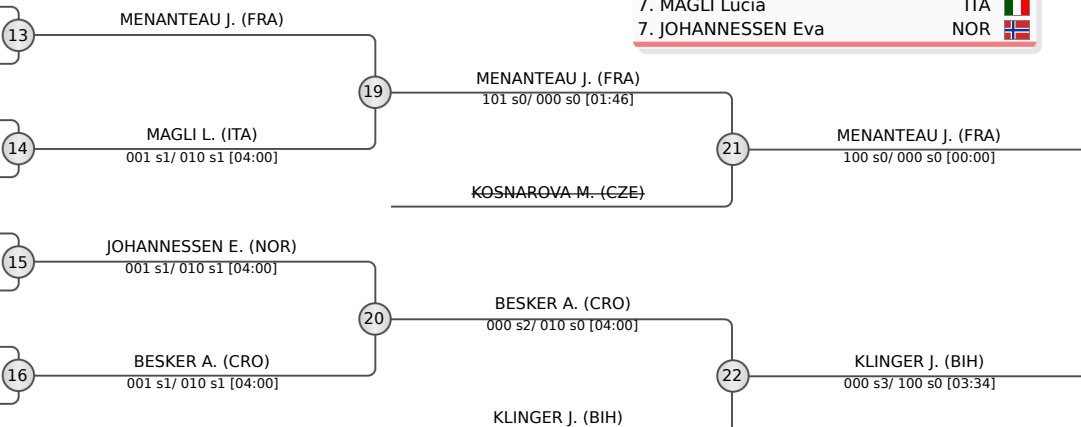

FINAL RESULTS		
1.	OTAWA Kokoro	JPN
2.	KATSUMATA Misuzu	JPN
3.	MENANTEAU Jeanne	FRA
3.	KLINGER Johanna Elisabeth	BIH
5.	KOSNAROVA Marie	CZE
5.	BESKER Ana	CRO
7.	MAGLI Lucia	ITA
7.	JOHANNESSEN Eva	NOR





Prague Junior European Cup 2026

Czechia, Prague, 4-5 Jul 2026

+78 kg

Juniors (15)

POOL A

	SOARES Ana	BRA
	KUBLER Sofia	ITA
	INOUE Tomoka	JPN

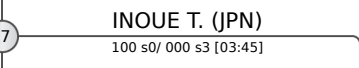
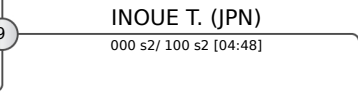
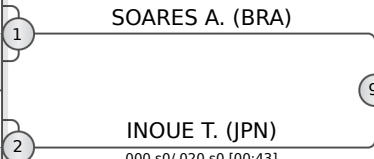

POOL B

	OLIVEIRA Olivia	BRA
	NOVAR Noemie	FRA
	EBONA Tessa	SUI
	BAHMET Kira	UKR

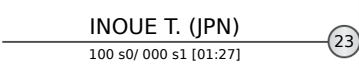
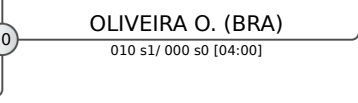
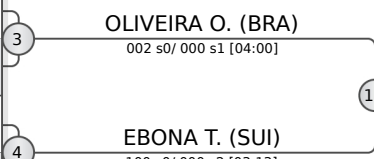

POOL C

	LAVIGNE Frederique	CAN
	LANDOLFA Valeria Luisa Maria	ITA
	HEURTEAU Bleuene	FRA
	NAGASATO Sakura	JPN

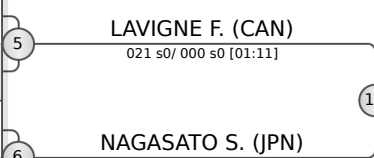

POOL D

	FILKOROVA Nina	SVK
	LEE Seungjin	KOR
	TELESCA Giulia	ITA
	SAMOLIUK Anna	UKR

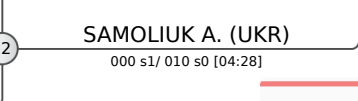
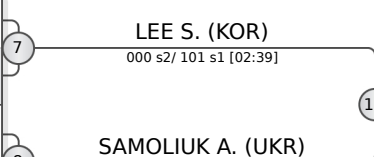

FINAL RESULTS		
1.	INOUE Tomoka	JPN
2.	NAGASATO Sakura	JPN
3.	SOARES Ana	BRA
3.	HEURTEAU Bleuene	FRA
5.	SAMOLIUK Anna	UKR
5.	OLIVEIRA Olivia	BRA
7.	EBONA Tessa	SUI
7.	LEE Seungjin	KOR

REPECHAGE

KUBLER S. (ITA)	SOARES A. (BRA)
NOVAR N. (FRA)	EBONA T. (SUI)
HEURTEAU B. (FRA)	HEURTEAU B. (FRA)
LAVIGNE F. (CAN)	LEE S. (KOR)
TELESCA G. (ITA)	
LEE S. (KOR)	

